

CEMP Engineer Design Guide 1110-3-110	Department of the Army U.S. Army Corps of Engineers Washington, DC 20314-1000	DG 1110-3-110 February 1983
	DESIGN GUIDE FOR LIBRARIES	
	Distribution Restriction Statement Approved for public release; distribution is unlimited.	

FOREWORD

The Design Guide (DG) series is issued under the standard design medium by the Engineering Division, Directorate of Engineering and Construction, Office of the Chief of Engineers, U. S. Army.

This guide governs design of U.S. Army Libraries and Technical Information Facilities. Included are Main Post Libraries, Branch Libraries, Scientific and Technical Information Centers, School Libraries, Medical and Legal Libraries and Classified Collections.

This guide provides planning and design guidance, discussed separately and in the form of example designs, which establish concept alternatives for evaluating project designs. This guide is applicable to all new construction projects for community libraries (Facility Category Codes 740-40 and 41) and for libraries and technical information centers built as a part of, or in conjunction with, medical (FCC 500 series), administrative (FCC 600 series), operational (FCC 140 series), and research facilities (FCC 310 series).

Preparation of this guide was under the direction of the Building Technology Section, Architectural and Building Systems Branch of the Engineering Division, and is based on the results of an architectural services contract with the firms of John Carl Warnecke & Associates, and George M. Ewing Company, New York, New York and Washington, DC under contract No. DACA 73-73-C-0020.

Material related to functional needs has been developed in conjunction with, and approved by, the Office of the Adjutant General, the Office of the Surgeon General, the Army Material Development and Readiness Command, the U.S. Army Library, the Office of the Judge Advocate General, the Office, Chief of Engineers, and the U. S. Army Training and Doctrine Command.

Distribution of this guide is limited. Additional essential copies are available from the OCE Publications Depot, 890 South Pickett Street, Alexandria, Virginia 22304.

Users are invited to send comments and suggested improvements to CDR USACE (DAEN-ECE-A) WASH, DC 20314.

FOR THE COMMANDER:

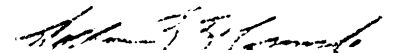

WILLIAM N. McCORMICK, JR.
Chief, Engineering Division
Directorate of Engineering and
Construction

TABLE OF CONTENTS

	<u>Paragraph</u>	<u>Page</u>
CHAPTER 1. INTRODUCTION		
Purpose	1-1	1-1
Scope	1-2	1-1
References	1-3	1-1
Emphasis	1-4	1-2
Responsibilities	1-5	1-2
Definitions	1-6	1-2
 CHAPTER 2. GENERAL PLANNING AND DESIGN CONSIDERATIONS		
General	2-1	2-1
Planning requisites and documentation	2-2	2-1
Analyzing the site and library location	2-3	2-1
Planning the building	2-4	2-2
Planning related furnishings and equipment	2-5	2-5
General design considerations	2-6	2-6
Design requisites and documentation	2-7	2-6
Site development	2-8	2-7
Building design	2-9	2-8
Structural system	2-10	2-14
Site design	2-11	2-15
Fire protection and safety	2-12	2-15
Finish details	2-13	2-15
Interior Furnishment	2-14	2-16
Provisions of user information	2-15	2-17
 CHAPTER 3. PLANNING UNITS FOR LIBRARY FUNCTIONS		
General	3-1	3-1
Collection storage units	3-2	3-2
Reading and study units	3-3	3-9
Staff work station equipment	3-4	3-14
 CHAPTER 4. INDIVIDUAL SPACE CRITERIA		
Entrance and lobby	4-1	4-1
Multi-purpose room	4-2	4-1
Public toilets	4-3	4-2
User card catalog	4-4	4-3
Control area	4-5	4-5
Reference area	4-6	4-5
Current periodicals area	4-7	4-5
Microform area	4-8	4-6
Stack area	4-9	4-6
Reading and study areas	4-10	4-6
Conference rooms	4-11	4-7
Study rooms	4-12	4-7
Typing and listening rooms	4-13	4-7
Children's area	4-14	4-7
Administrative staff offices	4-15	4-8
Technical services workstations	4-16	4-9
Shipping and receiving	4-17	4-9
Staff lounge	4-18	4-10

	Paragraph	Page
Staff toilets and lockers	4-19	4-10
Janitor's closet	4-20	4-10
Environmental criteria	4-21	4-10
 CHAPTER 5. SPACE ORGANIZATION PRINCIPLES		
General	5-1	5-1
Principles related to site constraints and opportunities	5-2	5-1
Principles related to basic spatial organization	5-3	5-2
Principles related to functional layout	5-4	5-5
Principles related to structure and environmental support	5-5	5-6
 CHAPTER 6. MAIN LIBRARIES		
General	6-1	6-1
Planning and design considerations	6-2	6-1
Individual space criteria	6-3	6-5
Summary of requirements and criteria	6-4	6-23
Space organization	6-5	6-26
Illustrative criteria application.	6-6	6-33
 CHAPTER 7. BRANCH LIBRARIES		
General	7-1	7-1
Planning and design considerations	7-2	7-1
Individual space criteria	7-3	7-2
 CHAPTER 8. SCIENTIFIC AND TECHNICAL INFORMATION CENTERS/LIBRARIES		
General	8-1	8-1
Planning and design considerations	8-2	8-1
Individual space criteria	8-3	8-3
 CHAPTER 9. SCHOOL LIBRARIES		
General	9-1	9-1
Planning and design considerations	9-2	9-1
Individual space criteria	9-3	9-1
 CHAPTER 10. MEDICAL LIBRARIES		
General	10-1	10-1
Planning and design considerations	10-2	10-1
Individual space criteria.	10-3	10-2
 CHAPTER 11. LAW LIBRARIES		
General	11-1	11-1
Planning and design considerations	11-2	11-1
Individual space criteria.	11-3	11-1
 CHAPTER 12. CLASSIFIED COLLECTIONS		
General	12-1	12-1
Planning and design considerations	12-2	12-1
Individual space requirements.	12-3	12-1

	<u>Paragraph</u>	<u>Page</u>
CHAPTER 13. Bibliography		
Purpose	13-1	13-1
U.S. Army Library Program: Army Publications	13-2	13-1
Library Planning and Design, General Information, Non-Army Publications	13-3	13-1
Planning the Army Library: Specific Facility Types	13-4	13-1
Master Planning, Site Planning and Design	13-5	13-2
Architectural Design	13-6	13-2
Structural Design	13-7	13-2

LIST OF FIGURES		<u>Paragraph</u>	<u>Page</u>	
Figure	2-1	Glass Shading, South Elevation	2-9	2-9
	2-2	Pictograph of Fire Extinguisher	2-9	2-12
	2-3	Safety Marking	2-9	2-12
	2-4	Changeable Wall Systems	2-9	2-13
	3-1	Double-Faced Shelving Units	3-2	3-2
	3-2	Shelving Unit Height and Accessibility	3-2	3-2
	3-3	Books and Bound Periodicals	3-2	3-3
	3-4	Periodical Display Units	3-2	3-4
	3-5	Storage Units for Manuscripts, Archives and Pamphlets	3-2	3-5
	3-6	Storage Units for Sheet Maps and Broadsides	3-2	3-5
	3-7	Art Prints, Pivoting Leaf Display	3-2	3-6
	3-8	Storage Units for Large Books, Bound Newspapers, Atlases, and Elephant Folios	3-2	3-6
	3-9	Microform Storage	3-2	3-7
	3-10	Current Newspaper Display Unit	3-2	3-7
	3-11	Record Storage	3-2	3-7
	3-12	Table Seating	3-3	3-10
	3-13	Lounge Seating	3-3	3-10
	3-14	Children's Seating	3-3	3-11
	3-15	Carrel Seating	3-3	3-11
	3-16	Enclosed Table Seating	3-3	3-12
	3-17	Study Rooms	3-3	3-13
	3-18	Microform Seating	3-3	3-14
	3-19	Desk Work Station	3-4	3-14
	3-20	Modular Control Desk Units...	3-4	3-15
	3-21	Independent Control Desk....	3-4	3-17
	3-22	Card Catalog Files	3-4	3-18
	3-23	Compact Shelving	3-4	3-19
	3-24	Catalog Reference Table; 4—Station	3-4	3-19
	3-25	Drafting Workstation	3-4	3-20
	3-26	Copy Machine	3-4	3-20
	3-27	Computer Terminal Work Station	3-4	3-20
	3-28	Teleconference Station	3-4	3-21
	3-29	Supply Cabinets	3-4	3-21
	3-30	Compact Kitchen Unit	3-4	3-21
	4-1	Toilet Area Critical Dimensions	4-3	4-3
	4-2	Card Catalog Example Layouts	4-3	4-4
	4-3	Staff Offices and Work Stations	4-15	4-8
	5-1	Parallel Organizational Scheme	5-3	5-2
	5-2	Axial Organizational Scheme	5-3	5-3
	5-3	Enclosed View Organizational Scheme	5-3	5-4
	6-1	Entrance and Lobby Space Utilization plan	6-3	6-5
	6-2	Multi-Purpose Room Space Utilization Plan	6-3	6-6

	<u>Paragraph</u>	<u>Page</u>
Figure 6-3	Public Toilets Space Utilization Plan	6-3 6-7
6-4	Public Card Catalog Space Utilization Plan	6-3 6-8
6-5	Control Area Space Utilization Plan	6-3 6-9
6-6	Reference Area Space Utilization Plan	6-3 6-10
6-7	Periodicals Area Space Utilization Plan	6-3 6-11
6-8	Children's Area Space Utilization Plan	6-3 6-13
6-9	Stack Area Space Utilization Plan	6-3 6-14
6-10	Administrative Librarian's Office Space Utilization Plan	6-3 6-16
6-11	Post Librarian's Office Space Utilization Plan	6-3 6-17
6-12	Extension Collection Space Utilization Plan	6-3 6-18
6-13	Technical Services Space Utilization Plan	6-3 6-19
6-14	Shipping and Receiving Space Utilization Plan	6-3 6-20
6-15	Staff Lounge Space Utilization Plan	6-3 6-21
6-16	Bookmobile Garage Space Utilization Plan	6-3 6-23
6-17	Diagrammatical Interpretation of Adjacency Relationships	6-5 6-28
6-18	General Use Functional Group (Spaces 1-3)	6-5 6-29
6-19	Public Service Functional Group (Spaces 4-12)	6-5 6-30
6-20	Staff Spaces Functional Group	6-5 6-31
6-21	User Flow	6-5 6-32
6-22	Material Flow	6-5 6-32
6-23	Staff Flow	6-5 6-33
6-24	Functional Requirements Diagram	6-6 6-37
6-25	Example Site Plan	6-6 6-38
6-26	Example Plan Layout	6-6 6-39
6-27	Floor Plan, Example Design No. 2	6-6 6-40
6-28	Floor Plan, Example Design No. 3	6-6 6-41
6-29	Floor Plan, Example Design No. 4	6-6 6-42
6-30	Floor Plan, Example Design No. 5	6-6 6-43
7-1	Public Toilets Space Utilization Plan,	7-3 7-2
7-2	Control Desk Space Utilization Plan	7-3 7-3
7-3	Periodicals Area Space Utilization Plan	7-3 7-4
7-4	Children's Area Space Utilization Plan	7-3 7-5
7-5	Stack Area Space Utilization Plan	7-3 7-6
7-6	Reading/Study Area Space Utilization Plan	7-3 7-7
7-7	Reading/Listening Area Space Utilization Plan	7-3 7-7
7-8	Staff Area Space Utilization Plan.	7-3 7-8
7-9	Example Plan Layout, Branch Library	7-3 7-10
7-10	Example Site Plan Layout, Branch Library	7-3 7-10
8-1	Entrance and Lobby Space Utilization Plan	8-3 8-3
8-2	Public Toilets Space Utilization Plan	8-3 8-4
8-3	Card Catalog Space Utilization Plan	8-3 8-5
8-4	Control Area Space Utilization Plan	8-3 8-5
8-5	Periodicals Area Space Utilization Plan	8-3 8-6
8-6	Reference Area Space Utilization Plan	8-3 8-7
8-7	Microform Area Space Utilization Plan	8-3 8-9
8-8	Administrative Offices Space Utilization Plan	8-3 8-10
8-9	Technical Services Space Utilization Plan	8-3 8-11
8-10	Classified Collection Space Utilization Plan	8-3 8-12
8-11	Staff Lounge Space Utilization Plan	8-3 8-13
8-12	Storage Area Space Utilization Plan	8-3 8-13
8-13	Shipping and Receiving Space Utilization Plan	8-3 8-14
8-14	Janitor's Closet Space Utilization Plan	8-3 8-14
8-15	Typical Siting for Technical Information Center	8-3 8-15
8-16	Example Technical Information Center 21,250 GSF	8-3 8-15

	<u>Paragraph</u>	<u>Page</u>
Figure 9-1	Control Circulation Desk Area Space Utilization Plan	9-3 9-2
9-2	Periodicals Area Space Utilization Plan	9-3 9-3
9-3	Reference Area Space Utilization Plan	9-3 9-3
9-4	Stack Area Space Utilization Plan	9-3 9-4
9-5	Classified Collection Space Utilization Plan	9-3 9-5
9-6	Reading Area Space Utilization Plan	9-3 9-6
9-7	Study Room Study Utilization Plan	9-3 9-6
9-8	Administrative Office Space Utilization Plan	9-3 9-7
9-9	Technical Processing Area Space Utilization Plan	9-3 9-7
9-10	Example Plan Layout for School Library	9-3 9-8
10-1	Spatial Relationship Diagram	10-3 10-3
11-1	Law Library Space Utilization Plan	11-3 11-3
12-1	Spatial Relationship Diagram	12-3 12-3
12-2	Example Plan Layout	12-3 12-4

LIST OF TABLES

Table 2-1	Furniture Utilization Factors	2-4 2-3
2-2	Seating for Functional Activities	2-4 2-4
2-3	Sound Reduction Goals	2-9 2-12
2-4	Comparative Cost and Flexibility of Wall Systems	2-9 2-14
3-1	Shelving Data for Books	3-2 3-1
3-2	Space Requirements—Storage Units	3-2 3-8
3-3	Space Requirements—Staff Work Stations	3-4 3-14
3-4	Card Capacity for Standard Card Cabinets	3-4 3-17
4-1	Public Toilet Fixture Requirements Based on User Populations	4-3 4-2
4-2	Staff Office	4-15 4-8
4-3	Environmental Criteria for Areas	4-21 4-11
5-1	Adjacency Chart	5-4 5-6
6-1	Composition of the Basic Collection	6-2 6-1
6-2	Staffing	6-2 6-2
6-3	Maximum Space Allowance for Main Libraries	6-2 6-3
6-4	Entrance and Lobby Space Requirements	6-3 6-5
6-5	Multi-Purpose Room Space Requirements	6-3 6-6
6-6	Public Toilets Space Requirements	6-3 6-7
6-7	Public Card Catalog Space Requirements	6-3 6-8
6-8	Control Area Space Requirements	6-3 6-9
6-9	Reference Area Space Requirements	6-3 6-10
6-10	Periodical Area Space Requirements	6-3 6-11
6-11	Children's Area Space Requirements	6-3 6-12
6-12	Stack Area Space Requirements	6-3 6-14
6-13	Reading and Study Areas Space Requirements	6-3 6-15
6-14	Typing and Listening Booths Space Requirements	6-3 6-15
6-15	Administrative Librarian's Office Space Requirements	6-3 6-16
6-16	Post Librarian's Office Space Requirements	6-3 6-16
6-17	Extension Collection Space Requirements	6-3 6-17
6-18	Technical Services Space Requirements	6-3 6-19
6-19	Shipping and Receiving Space Requirements	6-3 6-20
6-20	Staff Lounge Space Requirements	6-3 6-21
6-21	Staff Toilets Space Requirements	6-3 6-21
6-22	Janitor's Closet Space Requirements	6-3 6-22
6-23	Bookmobile Garage Space Requirements	6-3 6-22
6-24	Summary of Space Requirements	6-3 6-23
6-25	Summary of Environmental Criteria	6-4 6-24

	<u>Paragraph</u>	<u>Page</u>
Table 6-26	Summary of Finish Material	6-4 6-26
6-27	Identification of Adjacency Relationships	6-5 6-27
6-28	Example Staffing for Post Population of 44,000	6-6 6-34
6-29	Basic and Auxiliary Collection.	6-6 6-34
6-30	Space Requirements for Example Collection	6-6 6-34
6-31	Space Requirements for Adult Seating	6-6 6-35
6-32	Space Requirements for Services	6-6 6-35
6-33	Basic Space Requirements	6-6 6-36
6-34	Example Total Space Requirements	6-6 6-36
7-1	Typical Collection for a 4,000 GSF Branch Library	7-2 7-1
7-2	Public Toilets Space Requirements	7-3 7-2
7-3	Public Card Catalog	7-3 7-3
7-4	Control and Circulation Desk Area Space Requirements	7-3 7-3
7-5	Periodicals/Reference Area Space Requirements	7-3 7-4
7-6	Children's Area Space Requirements	7-3 7-5
7-7	Stack Area Space Requirements	7-3 7-5
7-8	Reading/Study Area Space Requirements	7-3 7-6
7-9	Reading/Listening Room Space Requirements.	7-3 7-7
7-10	Staff Work Area Space Requirements	7-3 7-8
7-11	Branch Library Summary of Space Requirements	7-3 7-9
7-12	Branch Library Adjacency Relationships	7-3 7-9
8-1	Example Staffing	8-2 8-1
8-2	Example Composition of Collection	8-2 8-2
8-3	Entrance and Lobby Space Requirements	8-3 8-3
8-4	Public Toilet Space Requirements (Hypothetical Example) (21,250 GSF)	8-3 8-4
8-5	Card Catalog Area Space Requirements	8-3 8-5
8-6	Control Area Space Requirements	8-3 8-5
8-7	Periodical Area Space Requirements	8-3 8-6
8-8	Reference Area Space Requirements	8-3 8-6
8-9	Stack Area Space Requirements	8-3 8-8
8-10	User Seating Space Requirements	8-3 8-8
8-11	Microform Area Space Requirements	8-3 8-8
8-12	Administrative Offices Space Requirements	8-3 8-9
8-13	Technical Processing Area Space Requirements	8-3 8-10
8-14	Classified Collection Space Requirements	8-3 8-12
8-15	Staff Lounge Space Requirements	8-3 8-13
8-16	Storage Area Space Requirements.	8-3 8-13
8-17	Shipping and Receiving Space Requirements	8-3 8-13
8-18	Janitor's Closet Space Requirements	8-3 8-14
8-19	Summary of Space Requirements for 21,250 GSF Example Facility	8-3 8-15
9-1	Example Collection for a 6,000 GSF School Library	9-2 9-1
9-2	Example Staffing for a 6,000 GSF School Library.	9-2 9-1
9-3	Control and Circulation Desk Space Requirements	9-3 9-2
9-4	Card Catalog Space Requirements	9-3 9-2
9-5	Periodical Area Space Requirements	9-3 9-3
9-6	Reference Area Space Requirements	9-3 9-3
9-7	Stack Area Space Requirements	9-3 9-4
9-8	Classified Collection Space Requirements	9-3 9-5
9-9	Additional Seating Requirements	9-3 9-5
9-10	Study Room Space Requirements	9-3 9-6
9-11	Administrative Office Space Requirements	9-3 9-6
9-12	Technical Processing Area Space Requirements	9-3 9-7
9-13	Summary of Space Requirements.	9-3 9-9

			<u>Paragraph</u>	<u>Page</u>
Table	9-14	Identification of Adjacency Relationships	9-3	9-9
	11-1	Example Collection for a 1000 GSF Army Law Library	11-2	11-1
	11-2	Stack Area Space Requirements	11-3	11-2
	11-3	Reading/Study Area Seating Requirements	11-3	11-2
	11-4	Staff Space Requirements	11-3	11-2
	11-5	Summary of Space Requirements	11-3	11-2
	12-1	Example 1000 GSF Classified Collection	12-2	12-1
	12-2	Summary of Space Requirements	12-3	12-2

CHAPTER 1

Introduction

1-1 PURPOSE

a. **PLANNING GUIDANCE.** This guide provides general guidance to aid installation and Corps of Engineers personnel in the planning of U.S. Army Libraries and Technical Information Facilities for inclusion in military construction programs.

b. **DESIGN GUIDANCE.** As the basic instrument governing the design of libraries and technical information centers, this guide is primarily intended to aid architects and Corps of Engineers personnel in the development and evaluation of project designs. This guide is directed towards the improvement of early design decisions and the development of realistic, cost-effective facilities in conjunction with Army and Department of Defense criteria and procedures

1-2 SCOPE

a. **GUIDE LIMITATION.** This design guide applies to all new construction projects for U.S. Army Libraries, including: Main Libraries, Branch Libraries, Scientific and Technical Information Centers/Libraries, School Libraries, Law Libraries, and Classified Collections. Medical libraries in teaching and non-teaching hospitals have been included in this design guide, although the programming methodology which is developed in this guide does not apply to these libraries. Medical library facilities are programmed by the U.S. Army Health Facility Planning Agency as part of its overall programming of military medical facilities. It is also applicable as a general guide document for projects involving the conversion or modernization of existing facilities. It applies to all construction programmed under Facilities Category Code 740-25. The guidance and criteria must be applied; however, in conjunction with information obtained from each particular installation defining the installation's proposed ACES program, and the constraints and opportunities of the project site.

b. **PRESENTATION OF GUIDANCE.** This guide is structured to aid in the development of project requirements and designs that respond to variables of each particular installation. Chapter 2 provides planning guidelines to help delineate library program requirements, space needs, and cost estimates for use in developing project requirements and programming data. Chapters 3, 4, and 5 provide general design criteria, individual space criteria, and space organization principles for use in developing and evaluating design solutions.

c. **EXAMPLE DESIGNS.** Examples illustrating the requirements and designs for libraries and technical information centers are included in Chapters 6 through 12 for each type of facility with the exception of Hospital Medical Libraries in Chapter 10. The designs demonstrate the application of criteria presented in Chapter 3, 4, and 5 in view of different installation variables. While indicating a suggested level of quality, they provide a means of evaluating proposed design solutions for actual projects.

1-3 REFERENCES

a. **DOD CONSTRUCTION CRITERIA.** The following manual is important in understanding the basic criteria governing the planning and design of Department of Defense facilities:

DOD 4270.1-M—Construction Criteria Manual

b. **PROJECT PLANNING AND DESIGN.** The following regulations are important in understanding procedures for planning and designing facilities in conjunction with the development of construction programs.

AR 210-55 — Funding and Personnel Support for Morale Welfare and Recreational Programs and Facilities

AR 230-1 — The Nonappropriated Fund System

AR 415-15 — Military Construction Army (MCA) Program Development

AR 415-17 — Cost Estimating for Military Construction Programming

AR 415-20 — Project Development and Design Approval

AR 415-35 — Minor Construction

c. **COMPLETION RECORDS.** The following regulation is important in understanding the kind of records transferred to the using service upon completion of project construction.

AR 415-10 — General Provisions for Military Construction

1-4 EMPHASIS

a. DESIGN QUALITY. Emphasis shall be placed on the quality of design since it will vitally affect the longevity, usefulness, efficiency, and attractiveness of the library. In addition to life cycle economy and functional efficiency, the overall design should exemplify regional character and an aesthetic rendering of both interior and exterior features.

b. DESIGN SERVICES. Architects for these facilities should be selected on the basis of knowledge in design of library facilities, and a demonstrated imaginative approach to site and building design. They should also be considered for their ability to provide or accomplish *professional interior design services*.

c. USER INFORMATION. Provisions related to the enhancement of facility operation, maintenance, and flexibility shall also be emphasized during design. Information to supplement construction completion records shall be prepared to instruct the installation on how to gain the most benefit from such provisions.

1-5 RESPONSIBILITIES

a. INSTALLATION. The Installation Commander and those who are in active charge of the library program and installation real property share the primary responsibilities of the installation. They are responsible for:

(1) Development and approval of functional requirements in conjunction with the criteria in this guide.

(2) Justification of functional requirements falling beyond the scope of criteria.

(3) Preparation and submission of the *Project Development Brochure* required by AR 415-20.

(4) Obtaining action to gain site approval if the project is not sited in accordance with the HQDA approved master plan.

(5) Preparation and submission of DD Form 1391, *Military Construction Project Data*, and supporting data in accordance with AR 415-15.

(6) Approval of concept designs to certify compliance with functional requirements.

(7) Procurement and placement of related furnishings and equipment.

b. DESIGN AGENCY. The Corps of Engineers field office responsible for design shall ensure that:

(1) Functional requirements of the installation are recognized and incorporated into the project design.

(2) Requirements of the installation fall within the scope of the criteria in this guide.

(3) Requests by the installation for deviations from these criteria are completely justified and documented.

(4) Quality standards for overall design are emphasized as stated herein.

(5) Assemblage of user information is complete at the completion of project construction, and provided, together with the completion records required by AR 415-10, to the installation (Facilities Engineer).

(6) Copies of appropriate user information are provided to the director of the ACES center.

1-6 DEFINITIONS

a. NET SPACE. The Net Assignable Square Feet (NASF) used for a specific function. It includes space required for internal (secondary) circulation within areas where appropriate.

b. GROSS SPACE. The total space, in Gross Square Feet (GSF), of all floors within the outside dimensions of the building, excluding central mechanical equipment space.

c. FUNCTIONAL REQUIREMENTS. Space performance, and operational requirements related to staff, instructional, and support activities, including circulation.

d. SPACE ALLOCATION CRITERIA. Standards prescribed to define and evaluate acceptable space allotments to satisfy functional requirements. In this guide, such criteria are often given as net assignable square feet (NASF), or in percentages of subdivisions thereof.

e. DESIGN CRITERIA. Standards prescribed to define and evaluate acceptable utilitarian, environmental, and aesthetic conditions to satisfy functional requirements.

f. SPACE ORGANIZATION PRINCIPLES. Rules exemplified in the organization of spaces into a building design.

g. LIBRARY A facility which collects, organizes, and disseminates documented ideas and information, regardless of format, quantity, or subject matter. Collected intelligence may include books, microform, tapes, records, computer data banks, films, photographs, paintings, drawings, pamphlets, magazines, correspondence, etc. . .

h. TECHNICAL INFORMATION FACILITY/LIBRARY. A library which specializes in information concerning a specific technical subject as engineering or ballistics.

i. POST LIBRARY. A library which maintains a balanced collection covering a wide range of subjects of general interest to personnel attached to a military installation.

CHAPTER 2

General Planning and Design Considerations

2-1 GENERAL

a. **PLANNING.** The first part of this chapter (2-2 thru 2-5) provides procedures to aid in development of functional requirements and subsequent preparation of planning and programing documents. The library program is the planning base for developing requirements which are eventually embodied into a building program. This chapter discusses building program development, and in particular, how to determine space needs and related requirements for site improvements, furnishings, and equipment.

b. **DESIGN** The last part of this Chapter (2-6 thru 2-15) discusses basic considerations for design and review of library and technical information center projects in relation to the individual space criteria and space organization principles in the following chapters. The discussion includes the design requisites and documentation required, basic site development and building design criteria, considerations for related furnishings and equipment, and provisions for user information. In addition, there are several overriding considerations that must be accounted for in all aspects of design.

2-2 PLANNING REQUISITES AND DOCUMENTATION

The sequence of steps for planning is delineated in AR 415-15. Once a need for a library center has been recognized by the installation, the building functional requirements and subsequent space needs must be established and documented along with the requirements of the site and future interior furnishings. This is the responsibility of the installation although assistance (using installation funds) may be obtained from the design agency if needed. If the library is the main facility, documentation must be prepared as stated below. When the library is to be built as a part of a larger facility, such as a hospital or laboratory, the requirements for the library must be included in the documentation for the main facility.

a. **PROJECT DEVELOPMENT BROCHURES (PDB).** Documentation is accomplished by first preparing a PDB as required by AR 415-20 and discussed in TM 5-800-3. Project requirements for libraries will be established in conjunction with the procedures and criteria in this guide.

b. **DD FORM 1391 (MILITARY CONSTRUCTION PROJECT DATA).** Preparation of DD Form 1391, with detailed justification paragraphs, is discussed in AR 415-15. Prepa-

ration of this form should be supported by the PDB previously prepared. All data entered on the DD Form 1391 must be carefully considered since project design must adhere to the requirements and estimates established thereon, as approved by HQDA. In preparing DD Form 1391, "DG 1110-3-110" should be entered under detailed justifications concerning criteria for libraries.

2-3 ANALYZING THE SITE AND LIBRARY LOCATION

a. **APPROVED CENTRAL SITE PLAN.** If the library is an independent building, the site shall be as shown on the HQDA approved Master Plan of the installation. If the facility is not shown thereon, a location must be selected and an approval obtained in accordance with AR 210-20. Location must be determined in response to the facility's functional requirements and take into account accessibility, capability for expansion, etc.

b. **PRELIMINARY SITE LAYOUT.** Although a detailed site plan is not normally required for submission with DD Form 1391, preparation of a site layout for independent library buildings will assist in preliminary budgeting. Tentative orientation of the facility should take into consideration the following factors:

- (1) Convenience of access for pedestrians, drivers, and service vehicles.
- (2) Sun angles and direction of prevailing wind.
- (3) Land Forms, grading, drainage and the tree coverage.
- (4) Views (desirable and undesirable).
- (5) Size location and sufficiency of utility connections.
- (6) Future expansion possibilities.

c. ESTIMATING SITE COST. Empirical cost estimating data are given in AR 415-17. Establishing the cost for the site is most important and should be made with the aid of a site layout sketch in conjunction with building requirements. Individual items should be listed under "Supporting Facilities" on DD Form 1391. The following list indicates typical items that should be considered:

- Site preparation
- Demolition
- Grading* and excavation
- Paving (drives, parking, and walks) *
- Fencing
- Landscape planting
- Signage*
- Water
- Sanitary sewer
- Gas

* including features for the physically handicapped

- Exterior electric service
- Communications
- Special foundations
- Others, as appropriate

d. LOCATION WITHIN LARGER FACILITY. When the library is to be a part of a larger facility or building, the library should be located on the ground floor, if possible, to reduce structural problems. Other factors which should be considered in locating the library are:

- Access and proximity to users
- Access to service areas
- Fire separation areas
- Relative quiet and uncongested area conducive to study
- Proximity to break and vending facilities

e. LOCATION WITHIN REHABILITATED FACILITIES. In addition to the factors listed above, proposed locations of libraries in rehabilitated spaces must be carefully analyzed since the strength of the existing supporting structure will drastically change the area requirements of the library. A library relocated to a building or area with relatively light structural floor framing will require a wider spacing of stacks than if relocated to a building or area with heavy framing members.

2-4 PLANNING THE BUILDING

a. GENERAL METHOD. It is the responsibility of the library director to determine how much space will be required for the facility. Space requirements for any Army library are based on the mission, function, and collection size of the library projected over the next 5 years. These functions, services, and activities require certain furniture and equipment for their performance. That furniture and equipment, in turn, requires a determinate amount of space for location and access. The total of these spaces constitutes the actual space requirement, without which the library cannot fulfill its total mission. The assessment

of space requirements can be facilitated by an analysis based on space requirements for the collection, readers, staff, and support activities. Space requirements for planning most library functional units are presented in Chapter 3.

b. SPACE REQUIREMENTS FOR THE COLLECTION. A list of present and projected materials must be prepared by the librarian for use by the design agency. The number of collection storage units required for each type of material can be computed by dividing the number of projected items of the collection by the number of items per storage unit shown in Table 3-1 or 3-2 and rounding up. The number of storage units thus derived is then multiplied by the net assignable square feet per unit (NASF/unit) shown in table 3-2 to determine the actual space requirement for each type of material. Example: to store 15,680 reels of 35mm microfilm:

$$15,680 \text{ 35mm microfilm reels} \div 160 \text{ reels/drawer} = 98 \text{ drawers}$$

$$98 \text{ drawers} \div 4 \text{ drawers/unit} = 24.5 \text{ units or 25 units}$$

$$25 \text{ units} \times 15 \text{ NASF/unit} = 375 \text{ NASF}$$

The area requirement obtained in this way represents the total floor space required for storage and access to the item. By repeating this process for each type of material in the collection and adding the results, the total actual space requirement for the collection can be derived.

c. SPACE REQUIREMENTS FOR READING AND STUDY. There are three bases commonly used for determining the number of reader stations required. The basis used for computation must be relevant to the nature of the facility being planned and the user information available to the librarian.

(1) *Based on Collection Size.* Determination of reader stations for general, main post, branch post, and school libraries, and other libraries with similar usage characteristics should be based on the following formulas:

$$\text{NASF for User Seating} = 1.15 \times \text{NASF for collection}$$

$$\text{No. of reader stations} = \frac{\text{NASF for user seating}}{30 \text{ sf/reader station}}$$

(2) *Based on Experience*

(a) Where documented statistics are available concerning the number and types of users, these may be used as the basis for determining seating requirements. These must be evaluated against possible future changes in mission or use. Due to the effects of crowding on work efficiency and on the psychological "territory" required by workers, some kinds of reader stations are more efficiently used than others (see Table 2-1). Thus, individual study carrels are completely filled by one person, but multi-chair tables will seldom be filled to capacity. If 16 table and chairs are expected to be occupied during daily peak periods, 20 table and chair seats should be provided ($16 \times 1.25 = 20$) to allow comfortable working conditions and to handle occasional overloads.

(b) The peak load factor shown in Table 2-1 may be used to predict the effect of peak loads on the number of seats to be provided. Thus, if statistics indicate an average of 8 lounge seats are occupied during the day, then 8×1.67 or 14 seats will be occupied during peak periods and 14 x 1.5 or 16 lounge seats should be provided.

TABLE 2-1 FURNITURE UTILIZATION FACTORS

Reader Station	Comfort Factor	Peak Load Factor
Lounge	1.15	1.67
Table (General Reading)	1.25	1.50
Table (Conference and Seminar)	1.0	1.0
Carrel	1.0	1.25
Research Carrel	1.0	1.0
Terminal	1.0	1.0
Microform/AV, Index Tables	1.0	1.0
Typing/Listening	1.0	2.0

(c) If additional reader stations are contemplated for an existing collection, the number should be based on present seating inadequacy and justified by documented measurements of overcrowding during peak hours.

(d) If an existing collection is to be moved into new quarters, requests for additional seating should be based on considerations discussed above and on 5-year growth projections.

(3) *Based on Functional Requirements.* For most specialized library types, such as science and technical information facilities, seating must be determined based on an analysis of the functional activities supported by the facility. The type of seating necessary will be a function of the type and duration of the activity, the concentration level required, and the number of personnel participating jointly in each activity. The required *number* of each type of seating is a function of the number of times an activity is exercised daily, and the number of persons jointly involved in each exercise, as well as the comfort factor and the peak load factor described in Table 2-1. In Table 2-2, each type of seating is listed with the corresponding types of activities, durations, and personnel participation appropriate for it. Concentration levels are also listed from "1", denoting a minimal concentration level of short duration to "5", denoting intense concentration sustained over more than 8 hours. Table 2-2 should be analyzed to determine which activities are necessary to the performance of the mission and how many of each seating type are necessary to assure adequate access to the function by facility users. For instance, if browsing is an activity that is expected to occur approximately 40 times per 8 hour day and last on the average 1/3 hour for each browsing exercise, then the number of seats required for browsing is $40 \times .5 \text{ hr} \div 8 \text{ hr} = 2.5$ seats. These may be assigned to table or lounge

seating. The total seats required for each type of seating is determined by performing similar calculations for each activity, summing them and multiplying by appropriate utilization factors from Table 2-1. The following calculations are given as a possible example for table seating determinations:

Conversation	1.3 Seats
Browsing	2.5
Review technical articles	.3
Information search	.4
Problem solving	1.5
Study technical literature	.8
Total	6.8 seats
x Peak load factor	1.50
	10.2 seats
x Comfort factor	1.25
	12.75 seats

(Two tables seating 6 each should be provided.)

(4) *Reader Station Distribution.* All of the above methods, except that based on functional requirements, must be further analyzed to distribute the total number of reader stations among the various types indicated in Table 2-2. This distribution must be carefully reviewed to ensure that an adequate number of each type of station is available to meet each functional demand.

(5) *Actual Reader Station Space Requirement.* The total number of each type of distributed reader stations must be multiplied by the appropriate space factors found in Chapter 3 to obtain the total actual reader station space requirements.

d. **SPACE REQUIREMENTS FOR STAFF.** Space requirements for staff work stations are based on the staffing authorized for the library and the activities which each member of the staff must perform. Some members of the staff may require multiple work stations. Some work stations may be shared by several staff members. A work plan should be completed listing each function and activity performed by the staff, the equipment necessary for performance of each task, and the number of each type of equipment. A space requirement can then be generated by multiplying the number of each type of equipment by the appropriate space factor contained in Chapter 3 and totaling these. Some of the more common work stations are indicated in Chapter 4.

e. **SPACE REQUIREMENTS FOR SUPPORT SERVICES.** Space requirements for services which support the library can be determined by referring to the appropriate item in Chapter 4 or in Chapters 6 through 12. If a special service is required for an activity not contained in this guide, the space requirement may be computed using unit factors found in Chapter 3 and supplementary equipment catalog information.

TABLE 2-2 SEATING FOR FUNCTIONAL ACTIVITIES

Activity	Concentration Level	Duration	Personnel Participation	Type of Seating
Relaxation	1	Less Than 1 Hour	1	Lounge
Conversation	1	Less Than 10 Minutes	2-3	Lounge, Table
Discussion	3	More than 10 Minutes	2-12	Seminar
Browsing	2	Less Than 1 Hour	1	Lounge, Table
Music Listening	1	1 Hour	1	Lounge
	3	1-2 Hours	1	Listening Booth
Listening to Conference Recordings	4	1-4 Hours	1-3	Listening Booth
Participation in Teleconference	3-4	up to 8 Hours	1-12	Teleconference room
Review of Technical Articles	2	1 Hour	1	Lounge, Table
	4	1-2 Hours	1	Carrel
Bibliography Search	3	½ Hour	1	Index Table Carrel
Information Search	3	up to 1 Hour	1	Table
	4	2 to 8 Hours	1	Carrel
	5	More than 8 Hours	2-4	Research Carrel, Seminar Room
Problem Solving	3	up to 2 Hours	1	Table
	4	2-8 Hours	1	Carrel
	5	More Than 8 Hours	1	Research Carrel
	5	—	2-12	Seminar Room
Study Technical Literature	3	Less Than 1 Hour	1	Table
	4	1-8 Hours	1	Carrel
	5	More Than 8 Hours	1	Research Carrel
Computer Search	4	1-4 Hours	1	Terminal
Self-Paced Instruction	4	1-4 Hours	1	AV Carrel
Typing	3	1-4 Hours	1	Typing Carrel
Reading for interest	3	1-2 Hours	1	Lounge, Table
Microform Search	3	1-2 Hours	1	Microform Viewer

f. TOTAL ACTUAL SPACE NEEDS. A summary of all the NASF space requirements generated by the above procedures should be developed for each project, in the format of Table 6-6. The sum of these requirements, multiplied by 1.15 to allow for unassignable building area, such as circulation, walls, and duct space, is the total actual gross area (GSF) required for the library. Example:

Total Actual NASF requirement	=	25,652 NASF
Unassignable Bldg. Area (15%)	=	3,848
Total Actual Gross Area Requirement	=	29,500 GSF

If the facility is a Main Post or Branch Post Library the gross area requirement obtained above must be compared to the maximum gross area allowed by DOD. This is shown in Table 6-3, col 2, for Main Post Libraries and is 4000 SF for Branch Post Libraries. If the total actual gross area exceeds the DOD allowance the area requirement must be reduced by eliminating or reducing functions or collection until it meets the allowance. Space for mechanical equipment for heating, ventilation and air-conditioning should then be determined by an engineer taking into account central heating sources, solar application etc., and added to the gross area requirement. The sum obtained is the total space needed for the project for which funding must be programmed. See AR 415-15, 415-35 and 230-1 for fund programming procedures for regular MCA, minor MCA, and non-appropriated funds, respectively.

g. EXAMPLE DETERMINATIONS OF NEEDS. Detailed development of space needs based on collection size is demonstrated for Main Post Libraries in Chapter 6. Development of space needs using other methods is similar. Differences are stated above.

h. ESTIMATING BUILDING COST. AR 415-17 provides empirical cost estimating data for all types of facilities. The unit cost data shown in AR 415-17 for libraries includes equipment and furniture which is permanently built-in or attached to the structure. The following list indicates typical items that should be estimated as part of the building cost:

- (1) Built-in counters, sinks, and cabinets
- (2) Efficiency kitchen unit
- (3) Central PA and record-playing console and sound system
- (4) Telephone outlets
- (5) Computer terminal lines
- (6) Built-in typing and record playing counters
- (7) Built-in shelving and shelving mounted on tracks laid into floor
- (8) Built-in movable partitions
- (9) Built-in projection screens, bulletin boards, and display cases
- (10) Elevators and book conveyors
- (11) Floor and window coverings (except area rugs)

- (12) Signage and graphics
- (13) Other items normally installed as a permanent part of a building.

As a general rule, unit building costs for all types of libraries and technical information centers will be similar. For facilities such as hospitals and schools, which normally incorporate libraries, the unit cost shown in AR 415-17 for the overall facility need no adjustment for a library. For a facility such as an engineering office, an aggregate unit cost can be derived by prorating unit costs for office, library, and laboratory areas.

2-5 PLANNING RELATED FURNISHINGS AND EQUIPMENT

a. COORDINATING REQUIREMENTS. Principal items of furnishing and equipment are listed in the chapters dealing with each type of library under each individual space, generally on the figures showing space layout. Furniture and equipment that are portable or detached from the structure must be furnished by the installation. These items will be funded from an appropriation other than construction, and their procurement must be carefully coordinated to ensure that they will be available when required. All related furnishings and equipment needs must be identified in conjunction with planning the building in order to develop a totally integrated and useful facility; and in order to program funds and provide information on delivery schedules in relation to construction. In preparing DD Form 1391, plans for related furnishings and equipment must be described in detailed justifications.

b. ESTIMATING FURNISHINGS AND EQUIPMENT COSTS. Items "on hand" meeting furnishings and equipment requirements should be listed separately from items that must be procured. Sources for selection of furnishings and equipment to be procured, are provided in the GSA Federal Supply Schedules, the Federal Prison Industries Schedule of Products, and the general GSA supply catalog. These sources are mandatory, insofar as they meet requirements, and cost estimates should be based on prices therein escalated to time of actual procurement to meet the established delivery schedule. Quality factors relevant to the selection of furnishings are discussed later in this chapter. The following list indicates typical items of equipment and furnishings that should be considered.

- (1) Audio-visual equipment, TV systems
- (2) Training equipment and instructional apparatus
- (3) Desks, chairs, tables, and study carrels
- (4) Lounge furniture
- (5) Book stacks
- (6) Book trucks, storage and filing cabinets
- (7) Card catalogs and map cases
- (8) Microform equipment
- (9) Computer terminals
- (10) Reproduction machines
- (11) Telecommunication equipment

- (12) Wall clocks: Plug in
- (13) Outside furniture
- (14) Other items which are detachable or portable

2-6 GENERAL DESIGN CONSIDERATIONS

a. **BARRIER FREE DESIGN.** Libraries and Technical information centers must be accessible to all persons. Provisions will conform to the most current DoD criteria regarding design for the physically handicapped. Barrier free design is extremely important in both site development and building design and will provide valuable conveniences to the able-bodied as well as the handicapped. Sites and buildings must be organized in the early stages of design to ease access and egress in and around the facility: level changes must be negotiable by persons using wheelchairs, crutches, or braces; toilet rooms must be located, sized, and equipped to accommodate handicapped men and women; provisions must be made for parking, wheelchairs, and for seating crutch and brace users in carrels and typing booths, etc. Consideration must also be given to hard-of-hearing and visually handicapped persons. In multi-level libraries the service elevator, required to transport books, must be sized and located to accommodate wheelchair users,

b. **ENERGY CONSERVATION** Design of all Army facilities must be responsive to the requirement for conservation of natural resources. Natural environmental factors which tend to conserve energy (i.e., vegetation, orientation, "protection from winds, etc.) should be enhanced by the design. Building designs should incorporate passive energy design measures such as roof overhangs and sunscreens, and consideration should be given to use of active energy conversion systems such as solar heating. Many libraries have been successfully built underground or in a semi-buried location. The architect should consider the full potential of the site and energy-related activities of the facility in order to maximize the energy utilization efficiency of the design,

c. **LIFE CYCLE ENHANCEMENT.** During design, consideration must be given not only to the initial cost of construction, but also to the cost of operation, maintenance, and custodial care during the intended life of the building. Both initial and life cycle costs must be analyzed, especially in the selection of utility systems, exterior materials and interior finishes.

d. **OCCUPATIONAL SAFETY AND HEALTH ACT (OSHA).** The staff area of post libraries and all areas of other types of libraries should satisfy the work safety standards required by OSHA. ETL 1110-1-87 furnishes guidance concerning the application of these standards. Where a conflict exists between OSHA and DOD criteria, the more stringent criteria must be applied.

e. **LIBRARY TECHNOLOGY.** Present and anticipated technology must be considered in library planning because of its impact on space organization, staff requirements, mechanical, electrical and acoustic requirements,

as well as the space and storage requirements of the hardware itself. In addition to the technology which is already utilized in libraries, a number of other technological advances have present and future library/information center application. These include: telefacsimile; ultra microfiche; digital mass storage media; closed circuit and cable TV; mini-computers; laser recording and satellite transmission of information. These technologies are applicable in all types of libraries and consideration must be given in the design of libraries, and technical information centers to allow for their incorporation.

2-7 DESIGN REQUISITES AND DOCUMENTATION.

Project design development is discussed in AR 415-20. Use of the Project Development Brochure and DD Form 1391 data as approved by HQDA for inclusion in the proposed (or approved) military construction program, is prerequisite to design development which is the responsibility of the design agency.

a. **CONCEPT DESIGN.** Initially, concept design drawings and analysis are required to help verify costs, and further define the functional aspects of the facility before initiation of final design. Generally, the concept design will be completed by the design agency and approved by the installation before construction funds are actually appropriated. The following level of detail in documentation is required.

(1) *Site Plans.* Site plans will show, as a minimum, floor elevations, existing and finished grades, existing and proposed buildings, roads, parking, and utilities in the immediate project vicinity, outside utility connections, signage, existing vegetation, proposed lawns and planting masses, and solar orientation. Grading, paving, utility and landscape development plans must also be shown.

(2) *Design Drawings.* Design drawings will include as a minimum a graphic description of the design, including floor plans, sections, and elevations, with sufficient detail to describe the geometric and construction characteristics of the building; written specifications describing the required properties and/or performance of the construction, including materials, installation, workmanship, and methods; and an *interior design scheme* with complete schedules of finishes, color, patterns, and furnishings and equipment (attached and detached).

(3) *Design Analyses.* Design analyses will contain supporting data for all aspects of the design, including architectural, structural, mechanical, electrical and communication, fire safety, etc. Cost estimates for both primary and supporting facilities will contain basic determinations commensurate with level of detail of the rest of the design.

b. **FINAL DESIGN.** Final design will be based on the approved concept design. To assure that approved concept requirements have been met, an in-process review of design documents by the installation should be made near completion of final design. Final documents must be sufficient to allow the project to proceed to competitive bidding and construction contract award. Basically, the final design.

will include a design analysis, drawings, and specifications prepared in accordance with ER 1110-345-700, 710, and 720, respectively.

2-8 SITE DEVELOPMENT

Design of supporting facilities as part of the site development will be consistent with the project requirements previously established. Successful site design is embodied in developing an appropriate relationship between building and site, an efficient vehicular and barrier-free pedestrian system, and an overall landscaping and signage plan. These considerations are discussed in the following paragraphs. Reference should also be made to TM 5-803-3, Site Planning.

a. BUILDING-SITE RELATIONSHIP. In developing an appropriate building-site relationship, the terrain, soil characteristics, local vegetation, and climatic conditions of the site must be considered along with the utilities support, and relationships to other buildings in the area.

(1) *Terrain Configuration and Site Coverage.* The site design process requires analysis of the scale and character of the geographic and topographic features of the site. Large scale features, such as site slope characteristics, generally require specific architectural and landscape responses. Both large and small scale features should be considered from the standpoint of their potential landscape value. The building should be designed to blend with the contours of the terrain. If other considerations, such as solar orientation, dictate that the building cross contours, a multi-level building may be desirable. As a rule of thumb, the maximum recommended coverage of the site by the building is 40 percent. Optimum coverage is generally considered to be about 30 percent. Allowances for future expansion should also be considered.

(2) *Soil Characteristics and Drainage.* The organic composition and drainage characteristics of the soil is important to the design of building foundations and the economy of construction, as well as to the landscaping of the site. The drainage characteristics and compressive bearing strength of the soil are critical in foundation design and must be determined in accordance with TM 5-818-1, Procedures for Foundation Design of Buildings and Other Structures. The determination of soil drainage characteristics will also include assessing the effects of the proposed building and its adjacent paved areas on the ground water level. Overlot grading must be established to provide positive drainage of the entire site away from the building and outside facilities. Grading should be designed for optimum preservation for existing ground forms and drainage patterns.

(3) *Vegetation and Tree Coverage.* Existing vegetation and trees should be preserved in their natural setting to the greatest extent possible consistent with functional requirements. This can help reduce the environmental affects of wind and sun as well as the requirements for landscape planting and temporary erosion controls.

(4) *Climatic Conditions.* Skillful utilization of natural

environmental controls can significantly increase building utility and efficiency.

(a) *Wind.* Structures affect air movement. They block or divert winds or channel them through narrow openings. Normally, the entrance should face away from the prevailing winds, or should be shielded by vegetation or part of the building. Features should be placed on the site so as to control wind-blown trash or snow, and aid in dispersal of emissions (smoke, fumes, dust).

(b) *Sun.* Solar controls should be planned to help achieve maximum energy savings. External shading devices are the most effective means of solar shading. Deciduous trees can provide shade in summer and penetration of sunlight in the winter. In general, buildings should be oriented so that the longest wall faces south, to minimize energy use.

(5) *Exterior Utilities.* Utility support systems must be carefully analyzed with respect to location, connection into the building and subsequent operation and maintenance. Utility areas, such as for transformers, trash collection areas, etc., shall be screened by use of plantings, land forms, or architectural screens to blend with the surroundings.

b. PEDESTRIAN AND VEHICULAR SYSTEM. A safe and convenient pedestrian and vehicular system must be established. The system should separate pedestrian and vehicular activities as much as possible and incorporate requirements for the physically handicapped in accordance with EM 1110-1-103.

(1) *Walkways.* The pedestrian system is essentially established by the pattern of walkways designed to support access and egress to and from usable entrances of the library. Generally, walkways should be designed to complement the natural flow of pedestrian traffic, be 6 ft. wide, and slope no more than 1 in 24, blending to a common level with other surfaces. Where significant level changes are required, both steps and ramps should be provided. Walks crossing roadways must be marked and provided with curb ramps, if curbs are used.

(2) *Roadways.* Vehicular arterials should not run between the library and closely related user facilities such as a school. A pedestrian drop-off and pick-up zone should be provided near the main entrance designed to be barrier free.

(3) *Parking.* DOD 4270-1-M allows one parking space per 500 SF for post libraries. Parking spaces for other types of libraries must be based on special traffic analyses in accordance with DOD 4270.1-M. Provide and reserve convenient parking for handicapped persons. Provisions for motorbikes and bicycles should also be made.

(4) *Service Access.* Service roads and areas should be separated whenever possible from pedestrian oriented roadways, parking and walkways. It is essential that the vehicular system provide access for fire fighting equipment as well as for deliveries. Service areas and service roads must be sized to accommodate the turning radii and maneuvering requirements of the largest

vehicles. At the same time, the extent of paving should be minimized. Screening for service areas should be accomplished in conjunction with the screening of utilities features.

c. **LANDSCAPING AND SIGNAGE PLAN.** In conjunction with establishing the building-site relationship and the pedestrian-vehicular system, a landscaping and signage plan will be developed.

(1) *Signage.* Direction signs and signs identifying buildings, parking areas, service areas, and facilities for the handicapped are required and shall be developed as an overall system together with the signage required for the building as prescribed in TM 5-807-10.

(2) *Landscape Perception.* An important part of the landscape plan is consideration for the visual experience. A landscape is usually seen from an unlimited number of viewpoints, but a selected set of viewing positions can be designed into the landscape plan from where special features would be enhanced when viewed from those positions. Viewing positions will be established in conjunction with the design of the pedestrian system and the architectural image of the building. Sight lines from these positions must be carefully analyzed with respect to the visual and other aesthetic experiences to be created by the landscape plan; and with respect to the overall image to be established for the library. Sight lines from inside building windows are also important in developing the landscape plan as windows function as focal points on the landscape as well as provide natural light.

(3) *Planting Design.* Existing land forms, trees and vegetation should be preserved and incorporated into the landscape plan wherever possible. Plants can be used to modify or enhance climatic characteristics, reduce noise levels and control the flow of air. New plant materials should be available locally, easily maintained, and compatible with the surrounding environment without excessive irrigation needs. Where new materials are used, the initial plant size should be adequate to give the desired visual and protective effects. Parking areas should be screened with buffer planting and variegated with substantial islands of vegetation. For details on planting design, reference should be made to TM-5-803-1.

(4) *Outside Furnishings.* Where outside activities or other functions such as study or waiting occur, appropriate furniture and equipment will be provided as part of the overall landscape plan. Provide bicycle racks to accommodate bicycle parking as appropriate. Trash receptacles, bollards, light standards, and other common site elements shall be designed as part of an overall scheme. Items, fully attached to the site or building, will be included as part of the construction contract. Portable items will be included as part of the Related Furnishings and Equipment information to be developed for procurement by the installation.

(5) *Lighting.* Provide general parking and walkway lighting of 2 foot-candles at ground level. Areas accessible to the handicapped after dark must be lighted to 5 foot-candles at ground level.

2-9 BUILDING DESIGN

Building design will basically conform to the project requirements previously established, and applicable DOD, Army, and Engineer criteria. The quality of building design may very well determine whether or not the facility will maintain its usefulness and value. In this respect, successful development of the building's architectural image, functional layout, structure and environmental support systems, and interior detailing is of prime importance.

a. **ARCHITECTURAL IMAGE.** The architectural image is established by the characteristics of design that make the building appear inviting, adapted to the environment, and identifiable as a library. Most of the considerations identified below can be applied both to separate libraries and to libraries which are a part of a larger facility.

(1) *Inviting Design Characteristics.* The library must be inviting and convenient to visitors as well as routine users. Especially important are the location, expression, and identification of entrances in relation to the primary pedestrian and vehicular approaches. The design of the library should reflect the scale and nature of the activities involved and invite participation therein.

(2) *Adaptation to Environmental Context.* One measurement of good building design is the success with which the facility is adapted to its particular environment. Specifically, such factors as site and climate provide the basis for determining appropriate architectural responses. For example, a hot, sunny environment requires a facility that provides protection from heat and glare, with entrances that accomplish a comfortable transition between the bright sun on the interior and the relatively dark exterior. In wet climates, rain protection at exits and between building elements should be considered, and in colder climates, compact buildings that increase floor space per unit area of exterior surface and door circulation should be used. Environmental considerations such as these are an integral part of an attractive and functional design.

(3) *Facility Identity and Perception.* The library building or area must be readily identifiable as a unit and have a visually apparent organization that facilitates orientation and circulation. These basic perceptual qualities are essential to the further development of a system of viewing positions and settings to communicate the aesthetic intent of the building design. A series of viewing positions, intentionally planned into the approaches to the facility and continuing on into the space organization within, shall be established for this purpose, and identified in the design analysis. The settings will be composed of elements of the building design, such as the sizes and shapes of the buildings exterior masses and interior spaces, the color, texture, and lighting of those elements, and the visual articulation or decoration thereof.

(4) *Exterior Detailing.* The color, texture, and scale of building materials should generate visual interest, as well as establish characteristics appropriate to the overall scale and image of the installation. The articulation of the exterior mass of the building is also an important consideration.

(a) *Wall Shading.* A substantial proportion of the air-conditioning requirement for most buildings results from solar energy absorbed by building surfaces. By simply shading those portions of building receiving the most sun, cooling requirements can be significantly reduced. Methods of wall shading which should be considered include applying various forms of canopies or louvers to the walls, and use of deciduous trees. Each wall of the building may require a different treatment depending upon its orientation to the sun.

(b) *Control of Glass Area.* In cases where the shading methods (mentioned above) are not practical, the choice of window glass becomes important. At a radiation angle of incidence of 40 degrees, ordinary glass admits 85 percent of the solar thermal energy that strikes the glass surface, while reflective glass admits 63 percent, heat-absorbing glass 60 percent and certain specialized glasses as little as 28 percent. Windows may also be recessed as illustrated in Figure 2-1. Such a design shades the window glass, substantially reducing the amount of solar energy striking the glass surface.

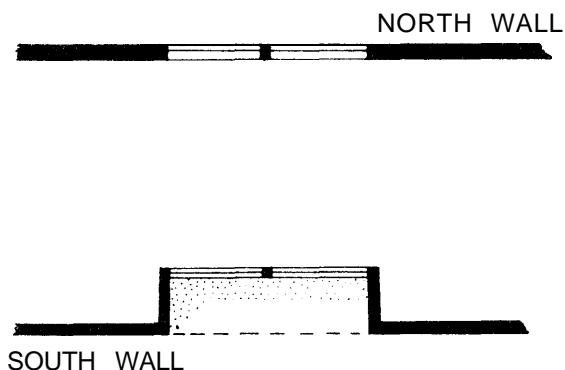

FIGURE 2-1 GLASS SHADING, SOUTH ELEVATION

b. **FUNCTIONAL LAYOUT.** The layout of library facilities is an extremely important part of the building design, affecting both the operational efficiency and performance of library activities as well as the cost of construction. An effective functional layout must relate to a standard space module, accommodate circulation flow and adjacency requirements, and conform to life safety criteria.

(1) *Standard Space Module.* Buildings are generally more economical to construct if designed in relation to a standard space module. A commonly accepted module in the building industry is the 5-foot square. Systems such as for ceilings, walls, lighting and air distribution are manufactured to readily adapt to the 5-foot square module.

(2) *Standard Building Modules.* Due to potential changes in the library programs, the library building's structural/service systems must have a high degree of adaptability. Flexibility to change should be facilitated by

adopting open planning techniques and minimizing the extent of partitioning. Modular structural design should be provided to accommodate possible rearrangement or conversion of space to other uses. Modular floor and ceiling elements and zoned mechanical and electrical services are also desirable. Modules should conform to 5 foot increments to accommodate standard book shelf units and widely available structural systems. A 30 foot square module creates an efficient stack layout. (See paragraph 4-9.e.) and is used in most of the example layouts in this guide.

(3) *Adjacency Requirements.* In developing the building design to meet the performance needs of the library program, spaces must be laid out to achieve essential adjacency relationships. Basically, there are three kinds of spaces needed to accommodate most library program functions; staff spaces, collection/user spaces, and support service spaces. Each group of spaces represents in itself an overall adjacency relationship. Examples of the relationship of one group to another as an element of basic spatial organization is discussed in Chapter 5. The relationship of one individual space to another, as discussed in Chapter 4, is an element of functional layout. Generally, this is based on the degree of interaction of personnel, material or activities between two or more spaces. The greater the degree of interaction, the closer the spaces should be together unless there are interposing requirements for safety, or need for acoustic or visual separation.

(4) *Circulation Flow.* Corresponding with the layout of space adjacencies, a convenient and workable circulation flow must be established. The flow of users and staff; materials and services should not interfere with one another even though they must interface at certain points. Circulation requirements will greatly depend upon how well adjacency requirements are satisfied, and whether or not space organization assists orientation to the building.

(5) *Circulation Nodes.* Horizontal circulation spaces should widen at points of queuing and decision, such as at corridor intersections, toilets, and entrances to stairways. At building entrances, the circulation space must provide for entering personnel to orient themselves and exiting personnel to prepare for outdoor weather conditions. A circulation node should also be provided at elevators required for transport of book trucks and physically handicapped persons in multi-storied facilities.

(6) *Evacuation.* The building's functional layout must conform to life safety requirements. Evacuation during an emergency requires all of the occupants exiting the building safely. This, in turn, means that limitations may have to be placed upon space sizes, locations, and distances from exits. Also exits and passageways from the building must be sufficient in number and size. In most emergencies, elevators will become unusable; therefore, rescue areas or other measures may have to be considered for protection of the handicapped in multi-stored buildings.

(7) *Related Considerations.* Functional layout may also be affected by other considerations. For example, areas where surveillance is desired should be laid out in such a way as to allow visual control of circulation and other activities. Spaces with functions having common characteristics, such as high noise levels, fire hazards or special requirements for interior detailing, structure, and environmental support, should be grouped together insofar as functional requirements for agencies will allow. Analyses should incorporate these and other considerations as appropriate to meet the requirements of each individual project.

c. **STRUCTURE AND ENVIRONMENTAL SUPPORT.** A successful building design must provide economical structural and environmental support systems selected for their ability to effectively support functional requirements and to operate efficiently. Environmental support includes heating, ventilation and air-conditioning, lighting, electrical power and communication, plumbing, fire safety, and acoustics.

(1) *Structural Design.* Design loads and criteria will be in accordance with DOD 4270.1-M and TM 5-809-1 through TM 5-809-6 and TM 5-809-8 through TM 5-809-12. The structural systems and materials selected will be suitable for permanent type construction, be capable of carrying the required loads, conform to the standard space module, and be compatible with fire protection requirements, architectural concepts, and functional requirements. The structure selected will be that system which is the most economical and suitable based on comparative cost studies for the building.

(2) *Protective Construction.* Design of structures for protection against seismic events and wind storms is prescribed in TM 5-809-10 and TM 5-809-11 respectively. In locations where a deficit in PF 100 fallout shelter space exists under the Army Survival Measures Plan, described in AR 500-3, selected areas of the structure will also be designed for dual use as fallout shelters. Technical and other requirements will be in accordance with TM 5-800-1, Construction Criteria for Army Facilities. Single-line plans showing locations, occupant loads, and minimum protection factors for the selected shelter areas shall be developed and included in project design analyses and completion records.

(3) *Ventilation, Temperature and Humidity Control.* A controlled thermal environment is an important factor in designing comfortable, safe, and effective research spaces. Investigations in the area of human performance show that when temperature and humidity become high, working efficiency decreases, errors increase, and under extreme conditions health is adversely affected. All provisions must be consistent with applicable Occupational Safety and Health Act (OSHA) standards.

(a) *Temperature Control.* Whenever the daytime outside temperature is above 55°F, heat gains will usually outweigh losses. Therefore, the fundamental problem in controlling the thermal environment in a library is cooling,

rather than heating the facility. The desirable temperature for a building depends on the activity of its occupants. Acceptable temperature limits vary from 60-70° for vigorous activity to 68-70°F for sedentary activity. In a library, where sedentary and vigorous activities are usually separated, separate temperature zoning should be provided. For example, packing and loading areas should be zoned for lower temperature than reading or staff areas.

(b) *Humidity Control.* Relative humidity has little influence on comfort, provided that it is in the intermediate range (30 percent to 70 percent). Humidity levels above 70 percent can impair human performance and levels below 30 percent can cause respiratory discomfort and create undesirable levels of static electricity in activity spaces. In rare cases, the library may require a more closely controlled humidity for preservation of a costly or irreplaceable collection. Justification for such cases should be provided on the DD Form 1391.

(c) *Ventilation.* In a closed, occupied space, the amount of oxygen in the air decreases and the amount of carbon dioxide increases. Normally, ventilation of 6-10 air changes per hour is sufficient for maintaining the proper balance between oxygen and carbon dioxide. Dust, pollen, and bacteria should be eliminated by air filtration. Ventilation criteria for individual spaces are summarized in Chapter 4. Air distribution systems should provide uniform air velocities generally not exceeding 40 feet per minute for an air-conditioned draft-free environment.

(4) *Mechanical Design.* Heating, air-conditioning and mechanical ventilation shall conform to the applicable portions of DOD 4270.1-M and TM 5-810-1. Heating and air-conditioning load calculations shall comply with the procedures of the latest ASHRAE Handbook of Fundamentals. The "U" values for exterior walls, ceilings, and floors shall be in accordance with DOD 4270.1-M. Design temperatures shall be 68°F for heating; 78°F for cooling. Various systems should be considered to accommodate the environmental requirements of the different types of spaces in the facility. Selection will be based on performance, least energy use and cost of operation and maintenance. Energy recovery systems should be investigated and incorporated into the design if economical. Reason for selection and rejection of systems must be included in project design analyses.

(5) *Cleaning Systems.* Cleanliness and dust control are essential elements of library collection maintenance. Surfaces and materials used should be easily cleanable and free of dust and dirt emitting capabilities. Where wall-to-wall carpeting is used, outlets of central vacuum systems and/or diagonal grounded receptacles for portable cleaning machines, should be provided at vertical support elements in open areas but no more than 40 feet apart in any area. Design of electrical outlets and HVAC registers should provide protection against the intrusion of dirt, dust, discarded trash, etc., and, when mounted on or near the floor, against entry of water, detergents and alkaline during cleaning operations.

(6) *Toilet Fixtures.* Both female and male toilets shall be provided to allow for convenient use by staff and users, including those who may be handicapped. The male-female ratio and fixture allocation are specified in Chapter 4 under individual space criteria for toilets, paragraph 4-3.c. At least one water closet and lavatory for each sex will be provided for the physically handicapped in accordance with current criteria.

(7) *Plumbing Design.* Plumbing must be in accordance with TM 5-810-5 (and TM 5-810-6 if gas fittings are required). Water supply facilities must be as prescribed in TM 5-813-3 and 6. Sanitary sewers must be as prescribed in TM 5-814-1. Plumbing and fixtures shall comply with the "American National Plumbing Code A 40.8" or the "National Standard Plumbing Code," within the limits established by DOD 4270.1-M.

(8) *Electrical Design.* Electrical design must conform to DOD 4270.1-M and TMs 5-811-1 through 4. The system selected will provide efficient and economical electrical service throughout the library. Voltages selected will be of the highest order consistent with the load served. Three phase 208Y/120 volts should generally be used to serve incandescent and small fluorescent or mercury vapor lighting loads, small power loads, and receptacles. Consideration should be given to the use of three-phase 480Y/277 volt systems where such is feasible. Distribution of power within the building should be located to afford maximum flexibility in room power supply and ready accessibility for circuit revisions. Primary electric service will be underground to a pad mounted transformer(s) located outside below grade where possible, and as close to the load centers as practicable. Building telephone service will also be underground with main terminal cabinets located in mechanical or electrical equipment rooms.

(9) *Lighting.* Light intensity criteria are given in the following chapters in maximum foot-candles (fc) with respect to task lighting, general lighting, special-effect lighting, etc. When criteria are not given, consult the latest edition of the Illuminating Engineering Society Lighting Handbook. Type of lighting should generally be fluorescent for general-area application, and incandescent for other applications. Provide sufficient switching capability to allow for reduction of light in areas that may be partially inactive. Requirements for dimmers and other special effects should be analyzed on a case-by-case basis and provided to create the image intended. Provisions must also be made for adjustment and/or relamping of light fixtures not readily accessible. Provide a master panel for lighting near the control desk.

(10) *Communications.* In accordance with current procedures in most localities, telephones and lines will be provided by the local communications-electronics officer. However, outlets, including those for public telephones, and empty telephone raceway systems will be provided as part of the building and designed accordingly. Designs must be coordinated with the local communications-electronics officer with evidence of such coordination pro-

vided in each project design analysis. Criteria for telephone outlets are given by number (and type) per use for individual spaces. Similar criteria are given for allocation of intercoms, public address speakers, and TV outlets where such systems are justified by the local using service. Care should be exercised to ensure placement of telephone outlets in areas requiring computer terminals, facsimile and other telecommunication facilities.

(11) *Life Safety.* Design provisions shall be made to ensure health and safety as set forth in Occupational Safety and Health Act (OSHA) standards and National Fire Protection Association (NFPA) codes augmented by DOD and Army criteria. Fire protection is a significant part of building design and involves the provision of resistive construction, detection and alarm systems, and extinguishment systems.

(a) *Resistive Construction.* Requirements for fire-rated walls, doors, floors, etc., depend upon the type of occupancy or hazards within a space. The objective is to contain and retard fires to allow evacuation, rescue and extinguishment. Resistive construction is especially important around passageways used for emergency exit.

(b) *Detection and Alarm.* Alarm systems are used as a general alert of danger whenever a fire occurs and is detected. Alarms can be supplemented by either heat or smoke detectors that sound an alarm automatically. In designing a system, consideration should be given to visual as well as audible alarms to aid those with hearing handicaps; to resisting vandalism; and to maintaining and checking the system's performance. Tie-in with the installation fire department may also be required along with annunciators to show which detectors and/or alarms are activated.

(c) *Extinguishment.* Sprinkler or other systems may be used or required in high hazard areas, e.g., in educational or storage spaces where hazardous materials are handled. These systems are normally activated automatically by heat. An automatic sprinkler system shall be provided in all portions of buildings located below the floor of exit; in all windowless classrooms, shops, and educational spaces not having exits leading directly to the outside; and in all shops, classrooms and storerooms in which hazardous materials are handled. Spaces where special electrical or mechanical devices such as computers, simulators, etc., are to be housed must be identified so that alternative extinguishment systems can be designed accordingly.

(d) *Safety Signals, Lights and Symbols.* Emergency exits from corridors should be marked so that a sign indicating the nearest exit is visible from every point in the corridor. Provisions for those with visual, as well as other physical impairments, must be made in accordance with applicable design criteria used in design for the physically handicapped. Illuminated exit signs and emergency lights for all emergency exits and passageways will be provided as required by the Life Safety Code, NFPA No. 101. The location of fire protection and other fire safety equipment

should be emphasized, where possible, with pictographs such as shown in Figure 2-2. Safety markings; signs for danger, warning or caution such as shown in Figure 2-3, should be designed in accordance with AR 385-30, Safety Color Code Markings and Signs, and OSHA requirements.

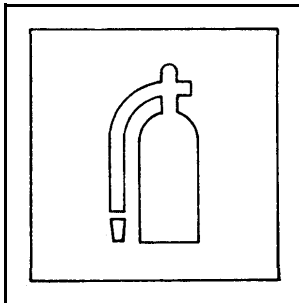

FIGURE 2-2

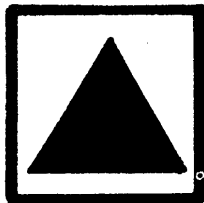

FIGURE 2-3

(12) *Fire Protection Design.* Criteria for fire protection, including fire and/or smoke detection, fire alarm, and extinguishment systems, are prescribed in DOD 4270.1-M, TM 5-813-6 and TM 5-812-1. These are generally based on the NFPA's National Fire Codes. Corridors, rooms, and exits must conform to the requirements for "flexible plan" buildings given in the NFPA Life Safety Code 101. Single-line plans showing fire-rated construction, location of detection and alarm systems, the location of exits and travel distances to them, areas where sprinkler and/or extinguishing systems are provided, and the location of other fire protection features shall be developed and included in project design analyses and completion records. These documents will indicate coordination of the fire safety design with the installation fire marshal.

(13) *Physical Security* The lock and keying system along with requirements for intrusion detection and protective lighting must be coordinated with the installation facilities engineer. Normally, locks will be grand master keyed to the installation's master key system with the library keyed to a sub-master key. The further need for master keys for selected parts of the library should be considered for large libraries. Overall, the physical security system must be designed so that its operation can be maintained effectively without interfering with life safety features.

(14) *Acoustics*

(a) *Ambient Noise.* Ambient noise is the back-

ground noise associated with a given space. It is generally a composite of sounds from mechanical equipment, street noise, and noise from nearby habitable spaces. The design ambient noise level for each library space is given in Chapter 4, in terms of A-weighted sound levels in decibels (dB).

(b) *Generated Noise.* Generated noise is the estimated overall peak airborne sound level in a given space, created by typical activities. The peak estimated sound levels for each individual space are also given in Chapter 4 for consideration in determining noise compatibility. These levels are generally 10-15 dB higher than the average long-term levels should be for each respective space.

(c) *Sound Quality.* This relates to the type of response a room should make to the noise generated within. A "live" room should have a low average absorption coefficient with hard surfaces to reflect most of the sound. Conversely, a "dead" room should have a high absorption coefficient with surfaces to absorb sound. Values given in Chapter 4 for sound quality are abbreviated as follows: L = live, ML = medium-live, AVE = average, MD = medium-dead, D = dead.

(d) *Sound Reduction.* Building design should allow a reduction in sound between library spaces as indicated in Table 2-3, Sound Reduction Goals. Each group of spaces have similar acoustic requirements. Reduction is achieved by a combination of interposed distance and barriers.

SOUND REDUCTION GOALS

Group 1	Entrance Lobby Multi-Purpose Room Toilets Children's Collection Typing/Listening Room	45		
		Group 2	Control Desk	50
Group 3	Card Catalog Reference Periodicals Stacks Reading Study Carrels Research Carrels			20
		Group 4	Conference Computer Terminal Technical Services Admin. Librarian Post Librarian Fxt. Collection	45
Group 5	Shipping/Receiving Bookmobile			45

Numbers represent sound reduction goals in decibels (dB) between spaces

Sound reduction should be measured in accordance with ASTM E 597-77T

TABLE 2-3

(e) *Effect of Distance and Interposing Barriers.*

Sound dissipates over distance. Doubling the distance from a sound source reduces the level of sound received by 6 dB. A similar reduction occurs for each doubling of distance between source and receiver. The operation of heavy armor or transportation equipment produces between 80 and 120 dB of sound at a distance of 20 feet. Aircraft may produce in excess of 140 dB. Assuming 100 dB at 20 feet, such sound would diminish to 94 dB at 40 feet, 88 dB at 80 feet, 82 dB at 160 feet, 76 dB at 320 feet on down to 34 dB at 40,000 feet (7 1/2 miles), etc. Since 35 decibels is the maximum desired ambient noise level for classrooms and study areas, distance alone generally is not a practical solution to reducing sound between the library environment and the outside environment or other related environments containing high noise-producing sources. However, if such sources can be located at a distance remote enough to allow reduction of the noise to an ambient noise level outside classrooms of 65 decibels, normal construction barriers can be reasonably designed to further reduce the noise to acceptable ambient levels within the classroom.

(f) *Background Noise.* Background noise is most distracting when the frequency range of the desired audio stimuli and the background noise are similar. For example, voice noise of 35 dB is more disruptive than mechanical ventilation noise of 35 dB.

(g) *Structural Considerations.* When libraries are located in facilities with high-intensity sound sources, these sources should be enclosed with sound-absorbing walls or shielded with sound-absorbing material. Machines that produce high-intensity structure-borne sound should

be acoustically isolated by special mounts. In such facilities, it may also be advisable to separate the library structurally from the rest of the building.

(h) *Mechanical Considerations.* Air-conditioning ducts may have to be treated to reduce noise transmission through the ducts. Space above ceilings, provided for distribution of ducts and other mechanical or electrical items, can allow excessive noise transmission from one space to another. Where such cases may occur, walls, or partitions should extend up to the underside of the roof or floor above.

d. *INTERIOR DETAILING.* The attractiveness and overall usefulness of the building are directly affected by the interior detailing of the building design. Interior detailing will be developed in conjunction with an overall interior design so that items which are part of the building contract are coordinated with related furnishings and equipment to be procured separately by the installation. Interior wall systems, finish materials, signage and color applications must be carefully considered in this regard. Permanent walls should be held to a minimum necessary for structural and fire resistance purposes. Transverse walls where practical should be semi-permanent or movable. Employ movable walls in those spaces in which changes in function of collection size are relatively frequent. Figure 2-4 shows some of the basic characteristics of the most common types of movable and semi-permanent interior wall systems. Table 2-4 provides data on the comparative costs and flexibility of wall systems. The designer must develop an accurate estimate of the frequency of functional change in a given space and, on that basis, select an appropriate interior wall system.

CHANGEABLE WALL SYSTEMS

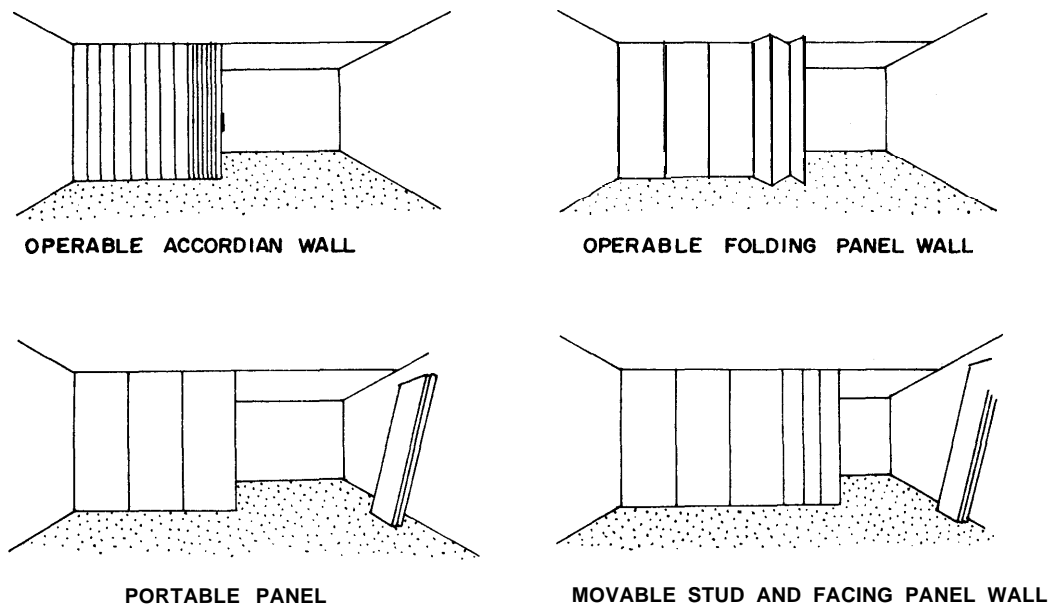

FIGURE 2-4

TABLE 2-4 COMPARATIVE COST AND FLEXIBILITY OF WALL SYSTEMS

Partition Type	Relative cost	Change Frequency			
		Hourly	Daily	Monthly	Yearly
Fixed (non-load bearing) 6" Concrete Block or 5" Wood Stud & Plaster	1	No	No	No	Yes
Movable	1.8	No	No	Possible	Yes
Accordion	2.6	Yes	Yes	Yes	Yes
Portable	3.2	No	Possible	Yes	Yes
Folding Panel	5.4	Yes	Yes	Yes	Yes

e. FUNCTIONAL OBJECTIVES

(1) *Circulation*. Depending on the nature of the activities involved, flows will be created for participants (staff and users), materials and, in some cases, furniture and equipment. Materials and equipment will include such items as may be required for instructional support, trash removal, repairs to the building and equipment, postal and vending service, etc. Circulation flows must interface at certain key points, yet not interfere with one another. Circulation of participants must allow for access-egress for physically handicapped persons and for safe evacuation of all persons in case of emergency. All such aspects must be incorporated into space organization in order to establish a workable, convenient, and efficient building and thus totally useful facility.

(2) *Adjacency*. The purpose and frequency of activities involved will establish patterns of compatibility and requirements for spaces to be adjacent to, or isolated from, one another. Adjacency is described in this guide in terms of the following criteria:

Adjacent—spaces with a shared wall or border, with direct access to each other.

Near 25 —spaces no more than 25 feet from each other —equivalent to maximum talking distance or 10-second walk.

Near 75 —spaces no more than 75 feet from each other —equivalent to maximum visual control or a 30-second walk.

Isolated —spaces isolated from each other to provide distance between noise or distraction.

(3) *Open Plan Flexibility*. Flexibility to change the function of library spaces should be facilitated through open planning by minimizing the extent of partitioning. Layout flexibility in structure and mechanical and electrical services should also exist so that spaces within the library can be utilized for different purposes without major alterations.

2-10 STRUCTURAL SYSTEM

a. *SELECTION*. Structural design loads and criteria must be in accordance with DOD 4270.1-M and TM 5-809-1 through 11, as applicable. The structural systems and materials selected shall be suitable for permanent type military facilities, capable of carrying the required loads, and compatible with fire protection requirements and architectural and functional concepts. Materials shall be selected for economy, general availability, and low maintenance costs over the design life of the facility. The structural system and features selected for construction drawings should be economical and suitable based on comparative cost studies for the building. Comparative cost studies should be made for the three most apparent competitive systems and should take into account mechanical, electrical, and other features.

b. *FLOOR CAPACITY*. To allow the greatest flexibility in floor layout and to provide for expansion of the collection, floors should be designed for a live load of 150 pounds per square foot throughout the building, except in toilets, bookmobile garages, and shipping/receiving areas. This loading will allow storage of approximately 15 books per square foot of stack area.

c. *PROTECTIVE CONSTRUCTION*. For areas where a deficit in PF 100 fallout shelter space exists under the Army Survival Measures Plan, described in AR 500-3, selected areas of the structure should be designed for dual use as fallout shelters. Technical and other requirements must be in accordance with TM 5-800-1. Single line plans showing locations, number, and the minimum protection factor for shelter spaces should be developed where applicable and included in the design analysis and completion records.

2-11 SITE DESIGN

Development of project site designs must be accomplished in accordance with applicable portions of DOD 4270.1-M and the Completed Project Development Brochure. Site design in general should be in accordance with TM 5-803-5. In addition, the following criteria should be considered:

a. BUILDING—SITE RELATIONSHIPS

(1) *Solar Loading.* Buildings must be oriented to minimize solar loads in order to reduce energy consumption for air-conditioning. Maximum direct radiation is received by a surface that is perpendicular to the sun's rays. Structures will receive substantially different amounts of radiation depending on their orientation. In general, buildings oriented so that their maximum exposed wall faces south will be most conserving of energy. In the cold climates, most of the spaces in the library should get some sun on a winter day. Also, spaces with large glass areas should not face toward the low western sun of summer, which is difficult to shield.

(2) *Wind.* Structures affect air movement. They block or divert winds or channel them through narrow openings. Normally, the entrance should face away from the prevailing winds, or should be shielded by vegetation or part of the building. Features should be placed on the site so as to control wind-blown trash and snow.

(3) *Views.* A landscape is usually seen from a limited set of viewpoints, such as from windows, entrances, terraces, balconies and paths. Sight lines from these critical points should be carefully analyzed. Windows should be located to provide contact with the natural environment as well as natural light.

(4) *Grading and Drainage.* Overlot grading must be established to provide positive drainage at a minimum 2 percent grade. Normally a 5 percent grade is provided for 10 feet adjacent to the building. Road alignments and overall grading should be designed for optimum preservation of existing ground forms, drainage patterns, and tree cover, to avoid excessive earth movement consistent with functional requirements. Grading should also be designed to aid access for the physically handicapped.

(5) *Exterior Utilities.* Utility areas, such as trash bins, transformers, utility connections, etc., should be screened to the maximum extent practicable by use of plantings, land forms, and architectural screens to blend with surroundings. Utilities located on roofs should be carefully studied during architectural detailing.

(6) *Site Coverage.* As a rule of thumb, the maximum recommended coverage of the site by the building is 40 percent. Optimum coverage is generally considered to be about 30 percent.

b. VEHICULAR AND PEDESTRIAN SYSTEMS

(1) *Circulation.* Safe and convenient vehicular, pedestrian and parking systems must be established. Vehicular and pedestrian circulation should be separated to the maximum extent feasible. Walkways should be de-

signed to complement the natural flow of pedestrian traffic into and around the project. Provisions for the physically handicapped should be in accordance with current criteria. Design of roads, streets, and pavements is discussed in TM 5-822-1 through 3.

(2) *Service Access.* Service access must be provided for fire fighting equipment, trash removal and the bookmobile (if any). Unloading facilities for book deliveries must be orderly in appearance and must not conflict with pedestrian or vehicular traffic. Service areas and service roads must be sized to accommodate the turning radii and maneuvering requirements of the largest vehicles. At the same time, the extent of paving should be minimized. Screening of service areas should be accomplished in conjunction with the screening of exterior utilities.

2-12 FIRE PROTECTION AND SAFETY

a. **FIRE SAFETY SYSTEM.** Fire protection shall be as prescribed in DOD 4270.1-M, TM 5-812-1, and TM 5-813-6. The fire safety system must be coordinated with the mechanical systems proposed for the project. Smoke detectors shall be as required by installation fire marshal. Floor plans should show lines of measurement indicating the maximum distance from major activity areas to exit(s). Cigarette receptacles, drinking fountains, fire extinguisher cabinets, and other equipment mounted less than 7 feet above the floor should be recessed so as not to protrude into exitways.

b. **SPRINKLER SYSTEM.** A wet pipe sprinkler system is required in the public and staff areas.

c. **SYMBOLS/MARKINGS FOR FIRE CONTROLS.** Illuminated exit signs and emergency lights shall be provided for all emergency exits and passageways as required by the NFPA Life Safety Code No. 101. Fire protection and emergency symbols shall appear in white on red squares, with wording as required by OSHA. The locations of exits, fire protection and other safety equipment should be strongly emphasized, as appropriate. Safety markings should be designed in accordance with AR 385-30, Safety Color Markings and Signs. Where possible, pictographs should be used as shown in Figure 2-2.

d. **EMERGENCY (FIRE) EXITS.** Emergency exits should require exitor to break glass to open the door and should be equipped with an alarm. Uncontrolled exits are a frequent problem in libraries. Push bar exits, even with alarm, are not an effective deterrent to unauthorized exit with library materials.

2-13 FINISH DETAILS

a. **MATERIALS.** Select materials based on maintenance qualities considering the anticipated use, life cycle cost impact, fire and other safety requirements. Coordinate the decisions concerning the extent of carpet installation with the using service considering functional advantages such

as acoustics, safety and maintenance. Use native (local) materials to the greatest extent practicable. Long-life materials such as stone, tile, wood, plastic, and vinyl, should be used where they will not become quickly outdated. When change is anticipated, painted surfaces and removable coverings are relatively easy and inexpensive to refurbish and can be kept fresh and up-to-date in appearance. Coordinate the color and texture of materials to complement the overall building design and image desired.

b. **COLOR.** Use of color in Army facilities is limited to a practical number selected from Federal Standard 595A, Colors. General guidance for color selection is provided in TM 5-807-7, Colors for Buildings. Color should be used to stimulate human physical and emotional reactions and to enhance the overall functionality of the building. Use soft colors in study areas and consider brighter base colors and accents in casual seating spaces. In critical seating areas, glare, brilliant colors and great brightness differences, both in the lighting system and in the color of walls, floors, furnishings and equipment, should be avoided.

c. **SIGNAGE.** Signage shall be accomplished as prescribed in TM 5-807-10 for interior and exterior use. Coordinate final detail needs of the using service at the local level. The system should assure maximum economy ease of procurement and installation, and standardization of application throughout the building. It must inhibit vandalism but be flexible enough to enable the addition or deletion of information. The use of symbols instead of words is recommended where possible.

(a) *Notice Boards.* Notice boards help control clutter and can readily accommodate changing information. They should be used throughout the building wherever they will be most useful. A general notice board should be located in the entrance of the library. Smaller boards may be located next to entrances to activity areas where there is a need to elaborate upon the type of activity inside, or to give the names of participants or staff involved, schedules, etc. Simple notice boards can be created by providing a 2-foot to 6-foot wide field of a solid base color surmounted at the 7-foot level by a 6-inch white board with the word "Notices" in 4-inch lettering. One or two narrow cork strips at the 6-foot and 4-foot levels should be provided as required for thumbtacking notices.

(b) *Wall Graphics.* While mainly decorative, wall graphics may frequently incorporate useful information such as floor numbers, directional indicators and Army insignia. When properly designed for the purpose, they can also be most effective in adding interest and creating focal points in otherwise visually dull spaces, such as large rooms and circulation spaces. Art prints available for loan at the library should be displayed at strategic points throughout the building to augment the wall graphics and interior furnishment. Gallery walls should be provided with tracklights for illuminating the art prints.

2-14 INTERIOR FURNISHMENT

a. REQUIREMENTS

(1) *Coordination.* Final selection and layout of interior furnishings must be coordinated with the facility design. All features of the building, whether they are furnished and installed as part of the construction contract, or later provided by the using service from programmed OMA funds (see para 2-5) must be developed as an overall scheme. Final requirements shall be coordinated with the using service and the installation. Furnishings which are not part of the construction contract must be identified for procurement by the using service.

(2) *Mandatory Sources.* Items must be finally selected from the most current GSA Federal Supply Schedules, the Federal Prison Industries Schedule of Products and the GSA General Supply Catalog. Procurement by the using service from these sources is mandatory insofar as the items covered meet requirements. For items not listed in the mandatory sources above but which are part of the overall design scheme, appropriate guidance should be provided to allow procurement by the using service. Mandatory source schedules and catalogs must be reviewed carefully for their currency, as they may change to some extent quarterly to reflect cost changes and additions or deletions of contract items.

(3) *Layouts and Schedules.* Furnishing layouts and schedules must be in a form that can be readily understood by contractor and installation personnel who are responsible for procurement, and by personnel who are responsible for component placement and utilization after delivery. Display sheets consisting of placement plans, catalog illustrations, material/color samples, and perspective sketches of typical spaces, together with procurement lists, source data, and cost, should be developed as appropriate to accomplish this objective. Principal requirements and typical layouts are given for some individual spaces in Chapters 6 through 12.

b. SELECTION CRITERIA

(1) *Appearance.* Furniture is an integral part of the overall facility design and must be closely coordinated with the selection of colors and finish materials for consistency in appearance and quality. Clear relationships between the furnishings finish schedule and the finish schedules in the facility design documents should be evident.

(2) *Durability, Comfort, and Safety.* Careful attention must be given to all interior furnishings to ensure that the type of furniture chosen conforms to standards of durability, comfort, and safety appropriate for the use they will receive. Being generally mobile, furniture items are subject to handling. Parts that receive the most wear should be replaceable, and finishes should sustain regular cleaning. Colors, textures, sizes, proportions, shapes, and reflections are important comfort factors that should be considered. Furniture and equipment must withstand loading conditions without damage. Edges and surfaces should be smooth and rounded. Materials must be flame-retardant.

(3) *Mobility and Interchangeability.* Most interior furnishings should not require more than two persons to relocate them, or require an undue amount of time to assemble and disassemble. Whenever possible, care should be taken to choose multi-purpose furnishings aesthetically suitable for a variety of needs and activities. Stackable and foldable furniture should be considered for reducing bulkiness in storage and transport.

2-15 PROVISIONS OF USER INFORMATION

Records required upon completion of building projects are delineated in AR 415-10. Requirements for additional user information are established in ER 1110-345-700, Design Analysis. In developing designs, attention should be given to maximizing the efficiency of operating, maintaining and utilizing the facility, its spaces, built-in features, equipment, and furniture. Design features which facilitate or aid functionality, housekeeping, etc., should be described and instructions prepared to supplement design analysis and project completion records. The objective is to identify how to best utilize the facility design in a way that facilitates understanding by using service personnel. The following types of information should be considered in developing designs and provided to the using service upon project completion.

- a. SPECIAL CONSIDERATIONS
 - (1) Barrier-free features
 - (2) Energy conservation
 - (3) Occupational safety and health
- b. SITE DESIGN
 - (1) Utility service system
 - (2) Landscape features
- c. BUILDING DESIGN
 - (1) Functional features of space organization
 - (2) Space flexibility
 - (3) Design perception system
 - (4) Protective construction
 - (5) Modular changeability
 - (6) Environmental control features; HVAC, lighting, communications, etc.
 - (7) Fire prevention system; detection-signal systems, evacuation routes, etc.
 - (8) Security features, keying diagram
 - (9) Housekeeping and services; supply, trash removal, storage, relamping, equipment repair, postal and engineer services, etc.
 - (10) Finish materials maintenance
- d. EQUIPMENT AND FURNITURE
 - (1) Placement and flexibility
 - (2) Storage and maintenance

CHAPTER 3

Planning Units For Library Functions

3-1 GENERAL

This chapter presents requirements and design criteria for the various planning units which are used in library activities. These are discussed in terms of storage units, reading and study units, and staff and service units.

3-2 COLLECTION STORAGE UNITS

The storage of a library collection will include a wide variety of units necessary to respond to the varying requisites of the materials stored. The designer must first determine how many of each type of material must be stored. This information will be available from the librarian. The total number of each type of unit and the total NASF required can then be determined following the procedure contained in paragraph 2-4b. Storage capacities for units given in this chapter are summarized in Table 3-2.

a. BOOKS AND BOUND PERIODICALS.

(1) *Capacity.* Table 3-1, which follows, summarizes the capacity of 82 inch high single shelving units for various kinds of bound volumes. Unless otherwise indicated, standard shelving units used in this chapter are single-faced units. A single-faced unit is constructed to afford access to books from one side only. Double-faced units afford access from either side. Both single and double-faced units are available with closed or open backs. Double-faced shelving should be a constant depth from floor to ceiling. Each may be 8 inch nominal which accommodates 94 percent of all books, or 9 inch nominal, which accommodates 97 percent of all books, provided there is no back or separation, between the shelves and no diagonal bracing. When two 9 inch nominal (8 inch actual) shelves are arranged back to back (Fig. 3-1) each

TABLE 3-1 SHELVING DATA FOR BOOKS

Type of item	Vols. per foot of shelf	Vols. per foot of single-faced range 82" ht.	Vols. per shelf	Shelves per section	shelf depth in.	Vols. per single-faced section allowing 40% growth	Max. vols. per single-faced section
Circulating (Nonfiction)	8	56	24	7	8	100	168
Fiction	8	56	24	7	8	100	168
Economics	8	56	24	7	8	100	168
General Literature	7	49	21	7	8	88	147
Reference	7	49	21	6-7	8 & 10	88	147
History	7	49	21	7	8	88	147
Technical & Scientific	6	42	18	7	10 & 12	76	126
Medical	5	35	15	6-7	8 & 10	63	105
Law	4	28	12	7	8	50	84
Public Documents	5	35	15	7	8	63	105
Bound Periodicals	5	35	15	5-7	10 & 12	63	105
U.S. Patent Specifications	2	14	6	7	8	25	42
Art Books	7	42	21	5-6	10 & 12	76	126
Braille	4	24	12	5-6	15	43	72

shelf is 8 inches deep and there are 2 inches between shelves. This is the equivalent of an 18 inch deep double-faced section unit. Under normal circumstances, books up to 10 inches deep can be placed upright on these shelves, with 2 inches extended into the space between the shelves. If 8 inch nominal shelving is used, books up to 9 inches deep can be accommodated. A standard shelf height should be chosen which will accommodate most of the books, and allow shifting from one shelf to another. The standard book stack shown in Figure 3-2 has 7 shelves, 12 inches apart, and accommodates over 90 percent of all books. Oversized books can be accommodated in similar sections with 6 shelves, each one 14 inches

apart. Books and bond periodicals are usually housed in standard shelving which is 82 inches high, 36 inches wide, and 8, 10, or 12 inches deep, located in stack areas with a double faced shelving configuration. The range width of stack areas should be 5 feet in order to allow for a minimum of a 42-inch aisle space required for access by the handicapped. (See Figure 3-3). For children's collections, and for hospital libraries used by patients, 42-inch high or 60 1/2 inch high standard units should be installed having 3 and 5 shelves, respectively. Unit capacities must be adjusted to reflect the number of shelves used, but space requirements will be the same for units of all heights.

DOUBLE-FACED SHELVING UNITS

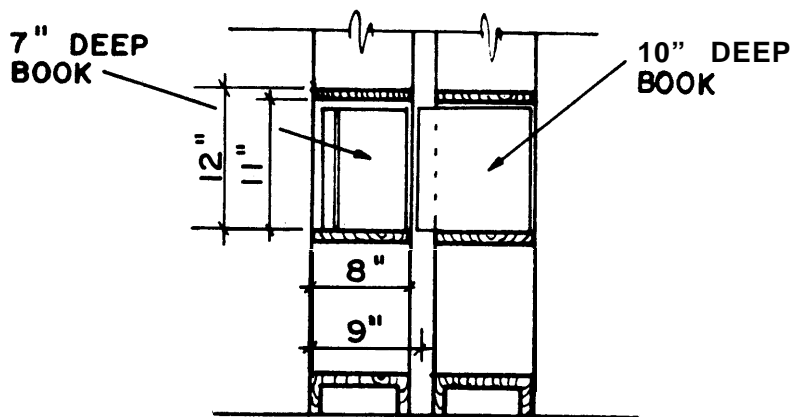

FIGURE 3-1

SHELVING UNIT HEIGHT AND ACCESSIBILITY

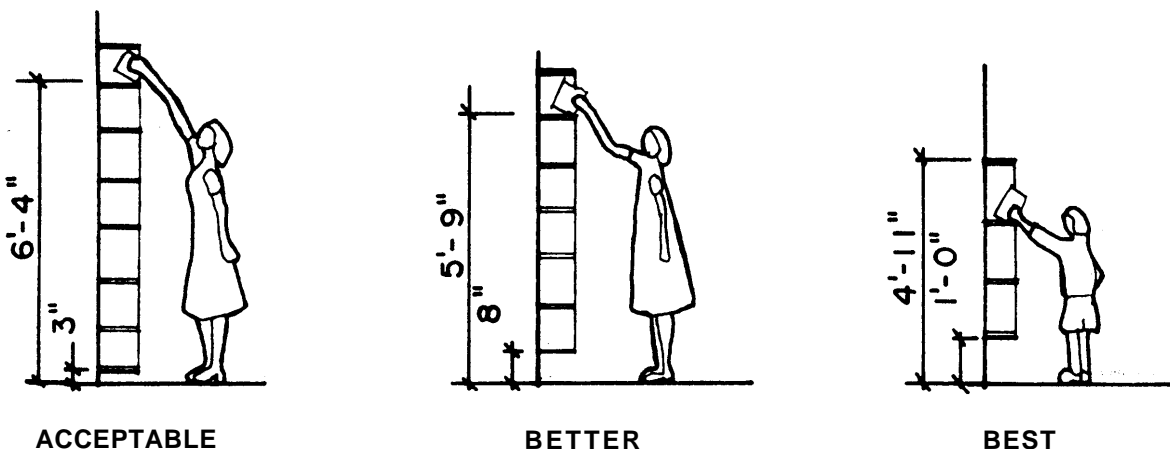

FIGURE 3-2

BOOKS AND BOUND PERIODICALS

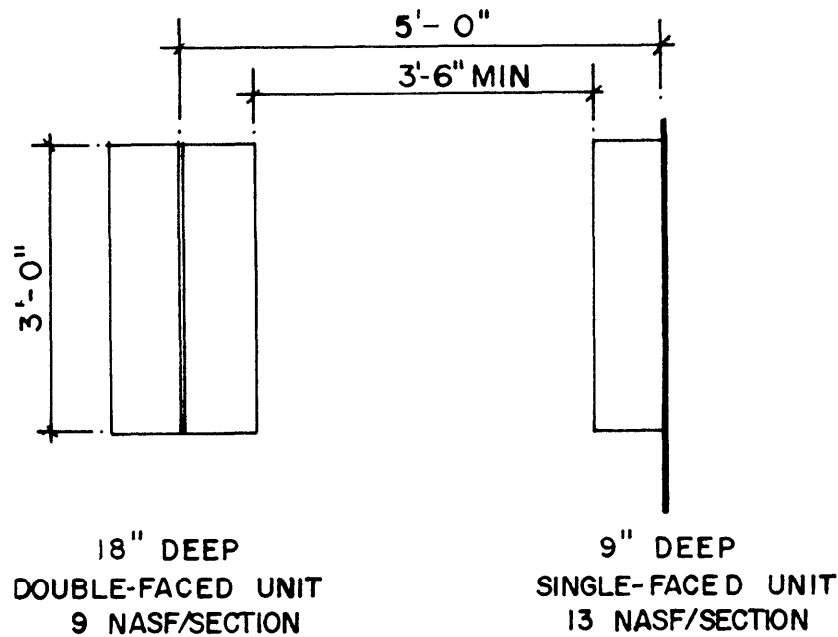

FIGURE 3-3

b. CURRENT PERIODICALS.

(1) *Capacity.* Current periodicals are usually stored in racks or display shelves. Standard racks are available in 5-shelf units, 48 inches high with a planning capacity of 15 titles, or 8-shelf units 60 inches high with a capacity of 32 titles. Display shelving is available in the three standard heights (42, 60, and 84 inches) with 2, 3, and 5 shelves, respectively. Shelves over 60 inches in height should not be used for periodical display because of its inaccessibility to wheelchair users.

(2) *Space Requirements.* Short rack units are approximately 36 inches wide by 16 inches deep and require 14.5 square feet each if used in single-faced sections. Tall rack units are 48 inches wide by 22 inches deep and require 19.5 square feet each. Standard display shelving units measure 3 feet by 12 inches and require 13.5 square feet. (See Fig. 3-4.)

PERIODICAL DISPLAY UNITS

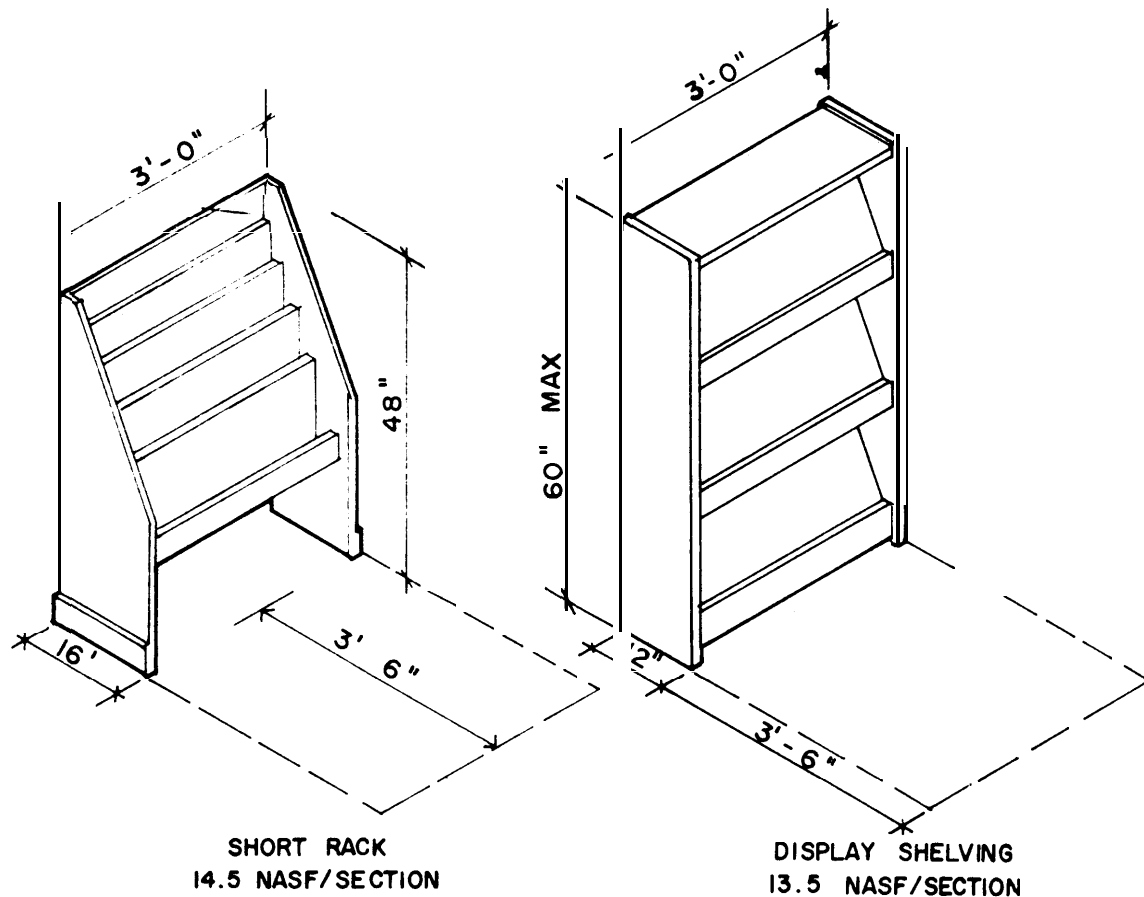

FIGURE 3-4

c. UNBOUND PERIODICALS, MANUSCRIPTS, ARCHIVES, AND PAMPHLETS.

(1) *Capacity*. After being displayed, unbound periodicals are usually boxed in princeton files or pamphlet cases, and stored on standard 82 inch high shelving units. Thirty 12 inch high by 12 inch deep by 4 inch wide cases of material can be accommodated per unit, or approximately 500 issues of average sized magazines. Manuscripts, archives, and pamphlets may be handled in the same way or may be stored as follows:

(a) Material to be kept for a limited period of time, then discarded, should be stored in lateral or vertical filing cabinets in the reference area. The 5-drawer file cabinets allow 7.5 linear feet of storage; 5-drawer lateral files allow 9.0 linear feet.

(b) Placed in 1/2 inch wide pamphlet binders and placed on standard shelving in the stack area. Use a planning capacity of 420 binders per shelving unit.

(c) Bound in 2 inch wide pamphlet volumes by subject and placed on 12 inch deep standard shelving in the stack area. Use a planning capacity of 100 volumes per shelving unit.

(d) Placed in cardboard records storage containers 10 inches high by 12 inches wide by 15 inches deep and stored on 16 inch deep standard shelving having a maximum capacity of 21 containers per unit. When storing documents in filing cabinets, lateral files, and storage containers, the total length of storage space required is usually the critical factor. If this figure is not available, it can be computed by estimating the number of documents which can be filed in a standard unit thickness of materials (1 inch for correspondence and other material with less than a dozen pages, 1 foot for material 1/4 inch thick or more) and then dividing the total number of documents on hand by the estimated number per unit to obtain the total length of storage space required. This storage requirement can then be used to determine the number of containers required.

(2) *Space Requirements*. Filing cabinets measure 60 inches high by 18 inches wide by 28 inches deep and require 10 NASF per unit. Lateral files measure 65 inches high by 36 inches wide by 18 inches deep and require 12 NASF/unit. (See Fig. 3-5.)

**STORAGE UNITS FOR MANUSCRIPTS,
ARCHIVES, AND PAMPHLETS**

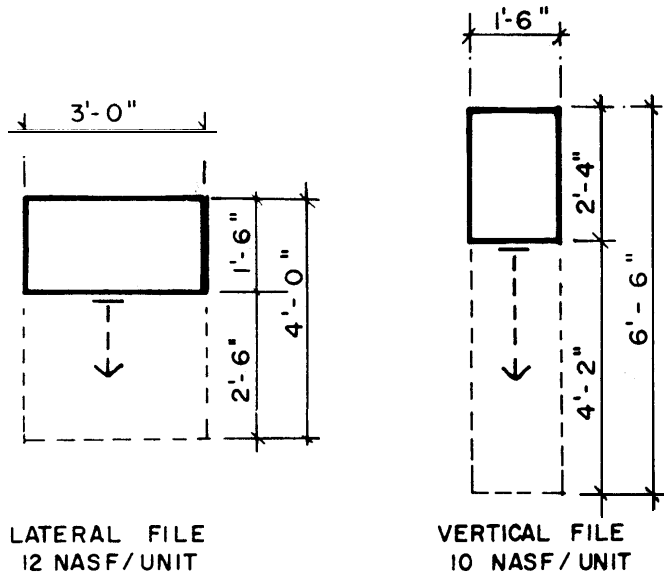

FIGURE 3-5

d. MAPS AND BROADSIDES.

(1) *Capacity.* These should be placed for protection into folders and stored flat in map cases. A standard map case 47 inches high by 49 inches wide by 38 inches deep will store approximately 1000 large maps and posters.

(2) *Space Requirements.* The standard map case requires 40 square feet per unit. (See Fig. 3-6.)

**STORAGE UNITS FOR SHEET MAPS
AND BROADSIDES**

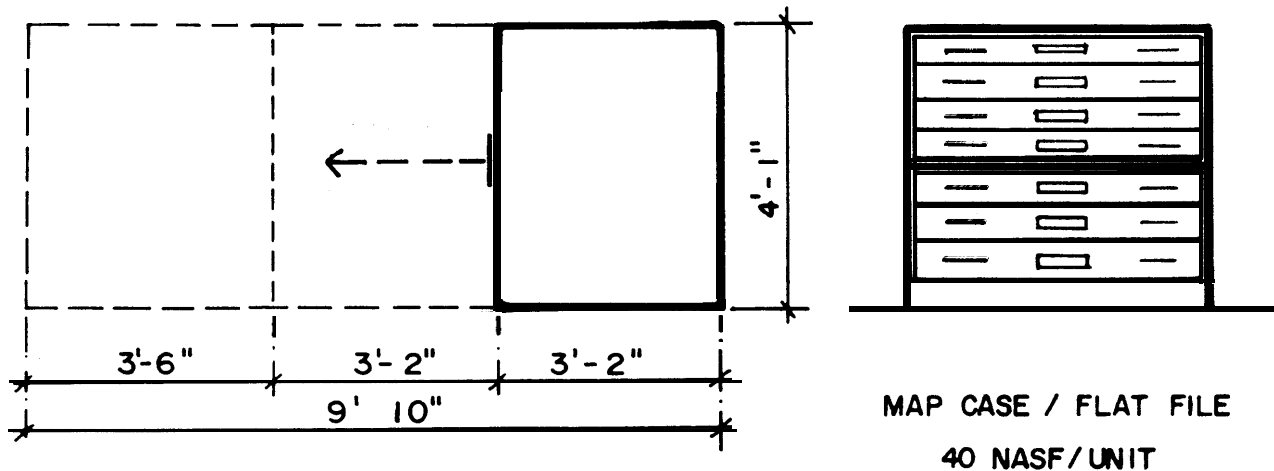

FIGURE 3-6

e. ART PRINTS.

(1) *Capacity.* Wall-mounted pivoting art display boards are available in sizes 20 inches wide by 30 inches high, 24 inches wide by 36 inches high, and 36 inches wide by 72 inches high. Standard wall-mounting rails can accommodate up to 25 double-faced board leaves. Free-standing units of up to 12 leaves are also available. In addition, walls of corridors more than 5 feet width may also be used for art display.

(2) *Space Requirements.* Allow 3 inches of wall length for each leaf. Allow 44 NASF for 6 leaves and 1.5 NASF for each additional leaf. (See Fig. 3-7.)

ART PRINTS, PIVOTING LEAF DISPLAY

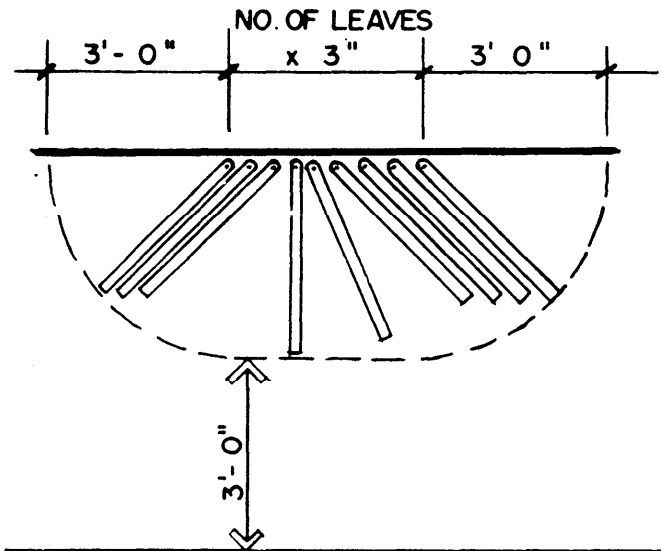

44 NASF FOR 6 LEAVES
1.5 NASF FOR EACH ADDITIONAL LEAF

FIGURE 3-7

STORAGE UNITS FOR LARGE BOOKS, BOUND NEWSPAPERS, ATLAS, AND ELEPHANT FOLIOS

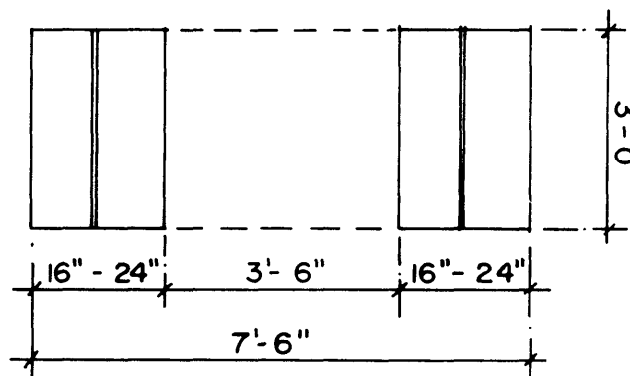

FIGURE 3-8

f. LARGE BOOKS, BOUND NEWSPAPERS, AND ELEPHANT FOLIOS.

(1) *Capacity.* Extra large items are shelved flat, preferably one per shelf, in 16 inch deep standard shelving units. (See Fig. 3-8.) Because of the weight of these stored items, shelving should be limited to a maximum height of 60½ inches. A 60½ inch high unit can accommodate 13 volumes. A 42 inch high unit can accommodate 8 volumes. Shelving is available at 18 inches and 28 inches deep, but only in metal utility shelving. Where less austere shelving of a depth greater than 16 inches is required, double-faced units without backs can be used effectively. The capacity of all depths of shelving is the same for these items.

(2) *Space Requirements.*

Shelving Depth (In.)	NASF	
	Single-Faced Units	Double-Faced Units
16	14.5	9
18	15	10
24	16.5	11

g. MICROFORM AND AV MATERIALS

(1) *Capacity.* Microform cabinets come in a variety of sizes. For most facilities, a multi-use cabinet is recommended containing separate drawers for each type of microform. Drawer units may be stacked to a maximum height of 52 inches, including an 8-10 inch base. A 36 inch wide by 18 inch deep drawer unit will hold any of the following:

Material	Drawer Height (In.)	Capacity
Film Strips	9½	540
	12	720
Cassettes	12	512
Film Loops	12	144
35mm Slides	9½	11,970
	12	13,960
Microfilm 16mm	12	272
	35mm	160
Microfiche	12	15,200
Audio Tapes 5 in.	9½	132
	7 in.	9½

(2) *Space Requirements.* A 36 inch wide by 56 inch high by 18 inch deep cabinet with a 4 drawer unit requires 15 square feet of floor space. (See Fig. 3-9.) Fewer than 4 drawers require the same space. Microform and AV materials storage drawers should be programmed in units of four.

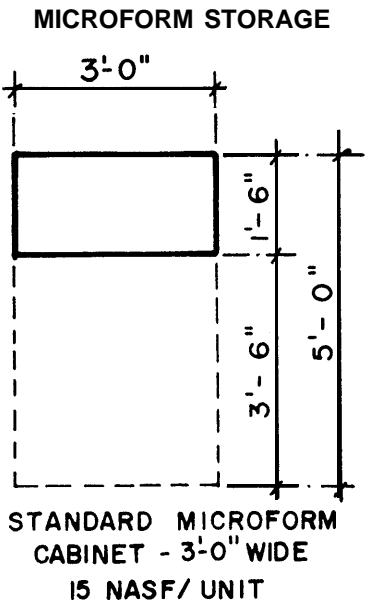

FIGURE 3-9

h. CURRENT NEWSPAPERS. Ten current newspapers (unbound) can be stored in a table-type newspaper rack which is 31 inches high by 36 inches wide by 26 inches deep. (See Fig. 3-10.)

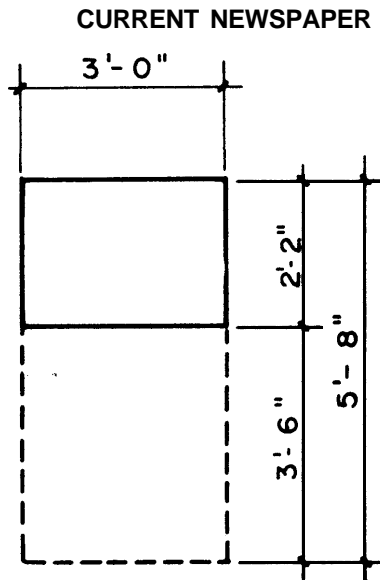

TABLE TYPE NEWSPAPER RACK
17 NASF/UNIT
FIGURE 3-10

i. RECORDS. Records can be stored in the following manner (See Fig. 3-11.):

- (1) Browser Box/Storage Unit-41 inches high by 56 inches wide by 19 inches deep for 500-12 inch LPs
- (2) Record Storage/Display Rack-46 inches high by 28 inches wide by 27 inches deep for 560-12 inch LPs
- (3) Record Shelving-82 inches high by 36 inches wide by 16 inches deep for 750-12 inch LPs
- (4) Record Display Carousel-24 inches wide by 60 inches high

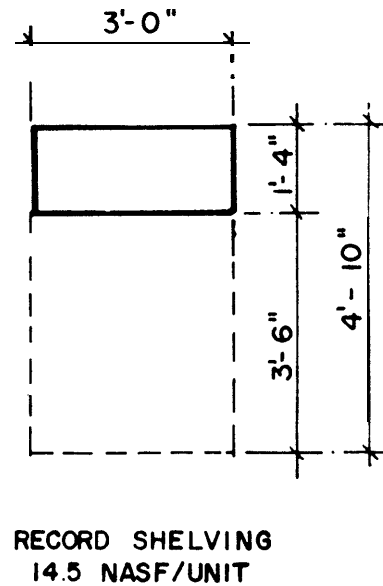
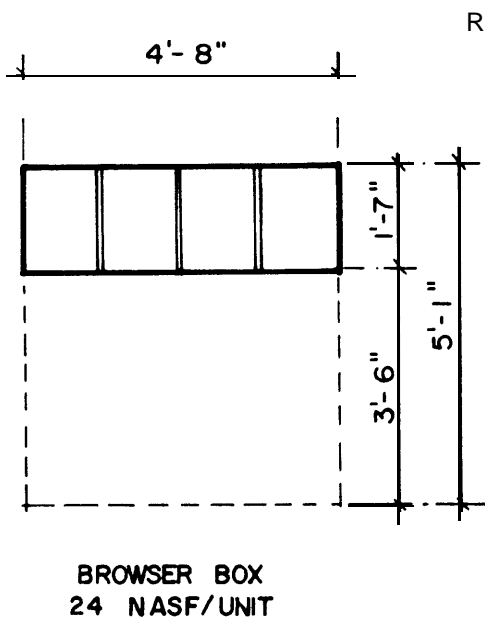

FIGURE 3-11

TABLE 3-2 SPACE REQUIREMENTS-STORAGE UNITS

Type of Material	Type of Storage Unit	No. Items/ Storage Unit	Unit Dim. (In.)	NASF/ Unit	Comments
1. Bound volumes	Standard shelving	See Table 3-1	82H, 36W, 8, 10, or 12D	9*	Typical stacks
2. Bound volumes	Medium Ht. shelving	See Table 3-1	60½H, 36W, 8, 10, or 12D	9*	Heavy books
3. Bound volumes	Low shelving	See Table 3-1	42H, 36W, 8, 10, or 12D	9*	Children's stacks
4. Bound periodicals	Standard shelving	See Table 3-1	82H, 36W, 10 or 12D	9*	Stack area
5. Bound newspapers	Low or med. ht. shelving	9	42 or 60½H, 36W, 16-24D	11*	Heavy books
6. Current periodicals	Displaying shelving	15 serials	82H, 36W, 12D	13½	Periodical area
7. Boxed periodicals	Standard	36	82H, 36W, 12D	9*	Stack area
8. Documents, pamphlets	Standard shelving	1000	82H, 36W, 18D	11*	
9. Documents, pamphlets	Vertical file, 5 dwr	500	48H, 18W, 28D	10	
10. Documents, pamphlets	Lateral file	varies	64H, 36W, 18D	12	
11. Reference volumes	Standard shelving	145	82H, 36W, 12D	9*	Reference area
12. Reference volumes	Medium ht. shelving	105	60½H, 36W, 12D	9*	Heavy books
13. Reference volumes	Low shelving	63	42H, 36W, 12D	9*	Heavy books
14. Maps	Map case	1000	47H, 49W, 38D	40	
15. Microfilm reels 35 mm	Cabinet	160	12H, 36W, 18D	15	
16. Microfilm reels 16mm	Cabinet	272	12H, 36W, 18D	15	
17. 35mm slides	4 dwr cabinet	15,960	12H, 36W, 18D	15	
18. 35 mm slides	3 dwr cabinet	11,970	9½H, 36W, 18D	15	
19. Microfiche	2 dwr cabinet	15,200	12H, 36W, 18D	15	
20. Newspapers unbound	Table type newspaper rack	10	31H, 36W, 26D	17	

TABLE 3-2 SPACE REQUIREMENTS-STORAGE UNITS (Continued)

Type of Material	Type of Storage Unit	No. Items/ Storage Unit	Unit Dim. (In.)	NASF/ Unit	Comments
21. Records	Browser/ storage unit	500	41 H, 56W, 19D	24	
22. Records	Storage/ display rack	560	46H, 28W, 27D	13	
23. Records	Record shelving	750	82H, 36W, 16D	14½	Oversized books also
24. Large books, ele- phant folios	Shelving with dividers	85	42H, 36W, 12D	9*	
25. Atlases	Atlas case	6	44H, 30W, 30D	25	

*Required NASF is based on standard shelving used in double-faced layout configuration. If used singly, standard shelving unit 82 inches high, 36 inches wide, and 8 inches-12 inches deep requires 13½ NASF and standard shelving 82 inches high, 36 inches wide, and 16-24 inches deep requires 16½ NASF. NASF includes access space.

3-3 READING AND STUDY UNITS

Determination of total space requirements and general characteristics for reader stations are discussed in paragraph 2-4b. This section discusses the different types of reading and study units which are used in library facilities, their area requirements and critical dimensions. Table 2-2 summarizes the types of stations appropriate for the various library activities.

a. **READER STATIONS.** Types of reader stations utilized in libraries include a variety of seating types which are appropriate to various areas, library functions, and work tasks. Following is a list of the basic reader stations and the area requirements for each.

(1) *Table Seating.* Table seating is appropriate for activities that do not require more than 2 hours duration and can accommodate minor distractions. It provides opportunity for small group interaction on common projects but may also be used for individual activities. Area required for 25 SF/seat.

(2) *Index Table Seating.* Index table seating is appropriate for activities related to information and bibliographic search. These activities require a medium level of concentration but are usually shorter in term than other table uses. It is generally located in or adjacent to the reference area and/or the card catalog. The index table also functions as a storage unit for bibliographic reference volumes. Area required is 25 SF/seat. (See Fig. 3-12.)

TABLE SEATING

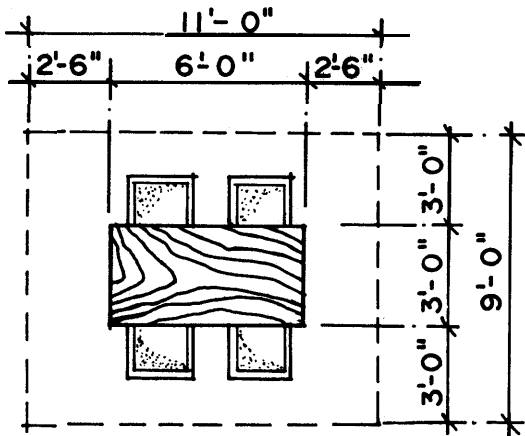
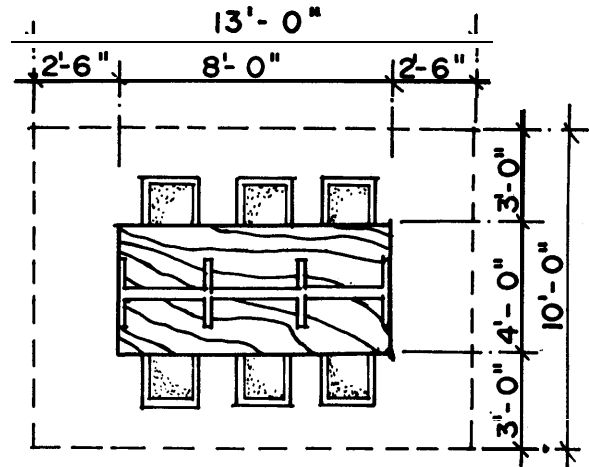

TABLE SEATING
25 NASF/SEAT



INDEX TABLE SEATING
25 NASF/SEAT

FIGURE 3-12

(3) *Lounge Seating.* Lounge seating is appropriate for activities similar to those afforded by tables but which do not require a writing surface or storage. It is appropriate to entrance/lobby areas, current periodical areas, and any other area where informal seating is considered desirable.

Lounge chairs can be grouped allowing for informal social interaction and minor conversation or placed back to back, to promote visual and social isolation. Lounge seating requires 30 SF/seat. (See Fig. 3-13.)

LOUNGE SEATING

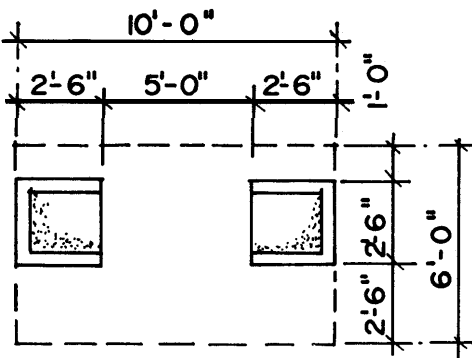

LOUNGE SEATING
30 NASF/SEAT

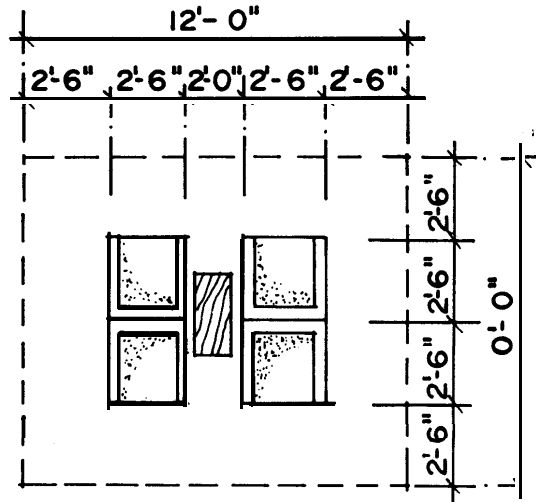

LOUNGE SEATING
30 NASF/SEAT

FIGURE 3-13

(4) *Children's Seating.* Seating in children's area of libraries includes three primary types: table seating, lounge seating, and cushions which can be placed on the

floor in informal groupings throughout the area. Table seating and lounge seating require 20 SF/seat whereas cushions require 15 SF/seat. (See Fig. 3-14.)

CHILDREN'S SEATING

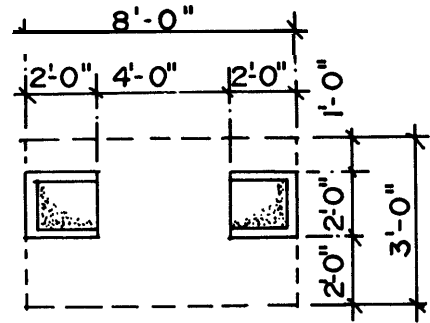
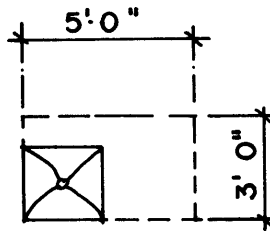
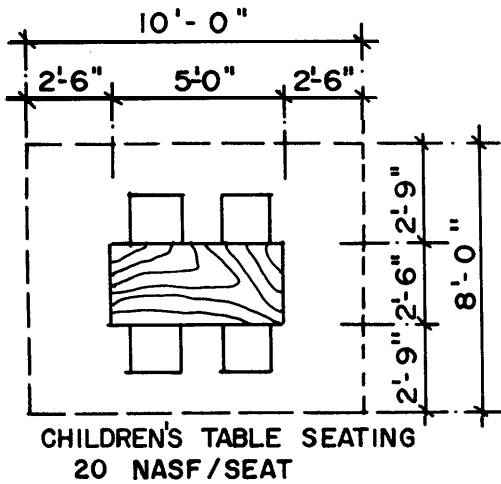

FIGURE 3-14

(5) *Carrel Seating*. Carrels are appropriate for individual activities requiring more isolation and longer usage (1 to 8 hours) than table seating. Carrels can be treated with varying degrees of visual and acoustic separation.

Research carrels should be enclosed on at least 3 sides and provide a large work surface and a bookshelf. Individual carrels require 30 SF/seat; research carrels require 40 SF/seat. (See Fig. 3-15.)

CARREL SEATING

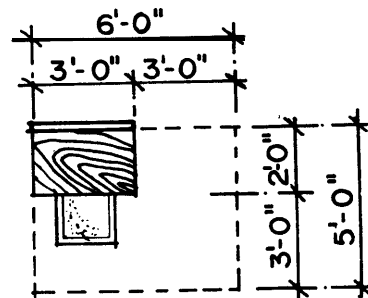
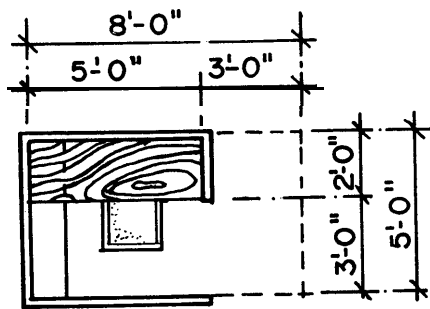

FIGURE 3-15

b. ENCLOSED READER STATIONS. Some activities require totally enclosed areas for acoustic and visual isolation. Such activities normally require more area than their unenclosed counterparts to afford a larger work space for each individual.

(1) *Table Seating*. Enclosed table seating (see Fig. 3-16) is appropriate for conferences, group study and research, seminars, and by other group activities requiring

acoustic isolation. A 2 foot by 3 foot table space should be provided for each person. Activities function best when all members of the group are able to talk casually without raising their voices, see each other's facial expressions, and pass written materials back and forth across the table. For small groups, this is best accomplished by a circular or nearly circular table in a square or nearly square room. Allow 30 SF/seat. If a rectangular room is used, allow 31 SF/seat.

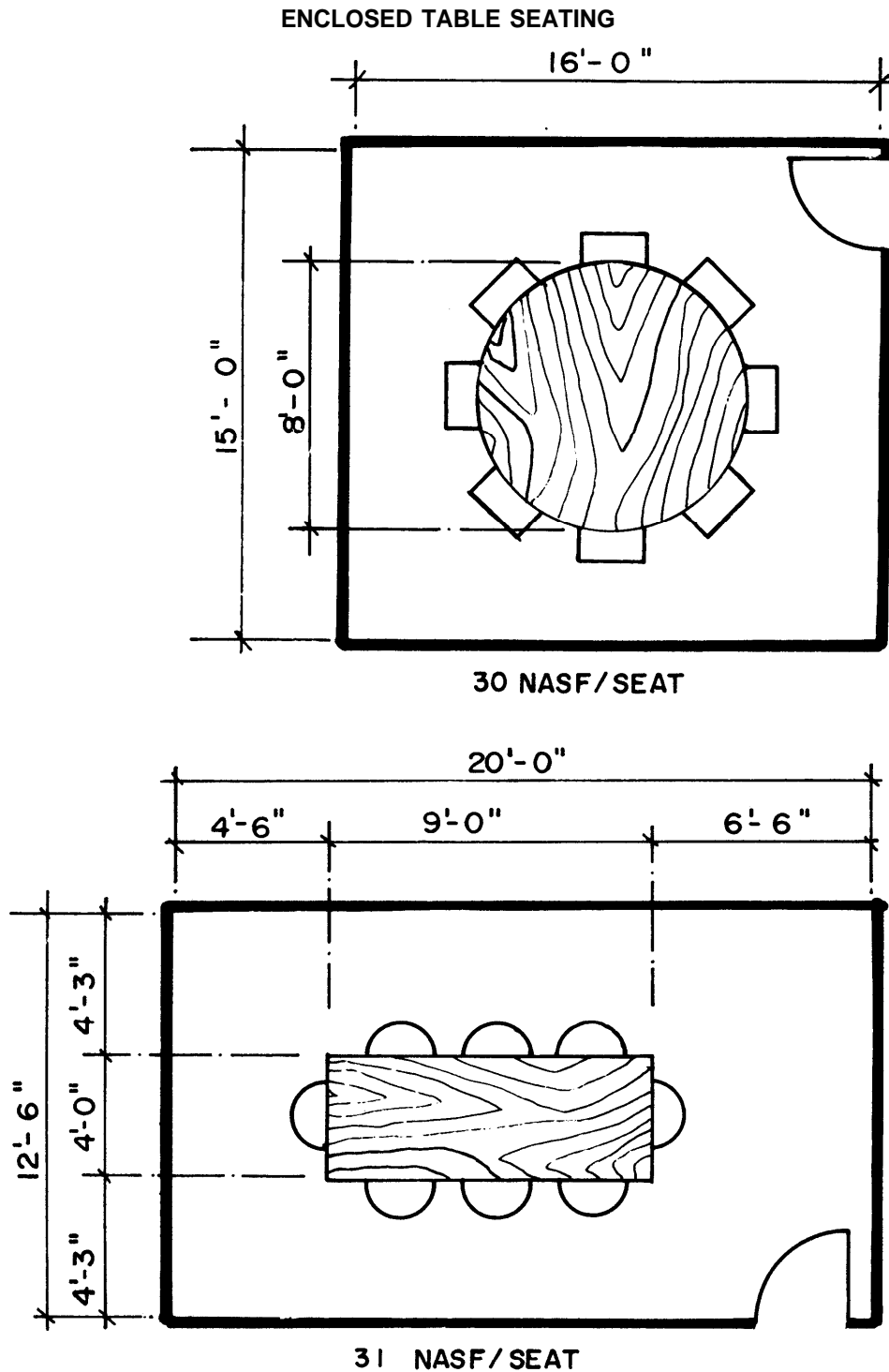

FIGURE 3-16

(2) *Carrel Seating.* Enclosed carrel seating and study rooms are appropriate for library activities which require complete acoustic isolation such as typing, audio-visual equipment, and group research. They are also use-

ful for individuals who are doing research over an extended period of time. Space requirements should generally be figured at 36 SF/individual study carrel and 30 SF/seat for study rooms which accommodate two or more people. (See Fig. 3-17.)

STUDY ROOMS

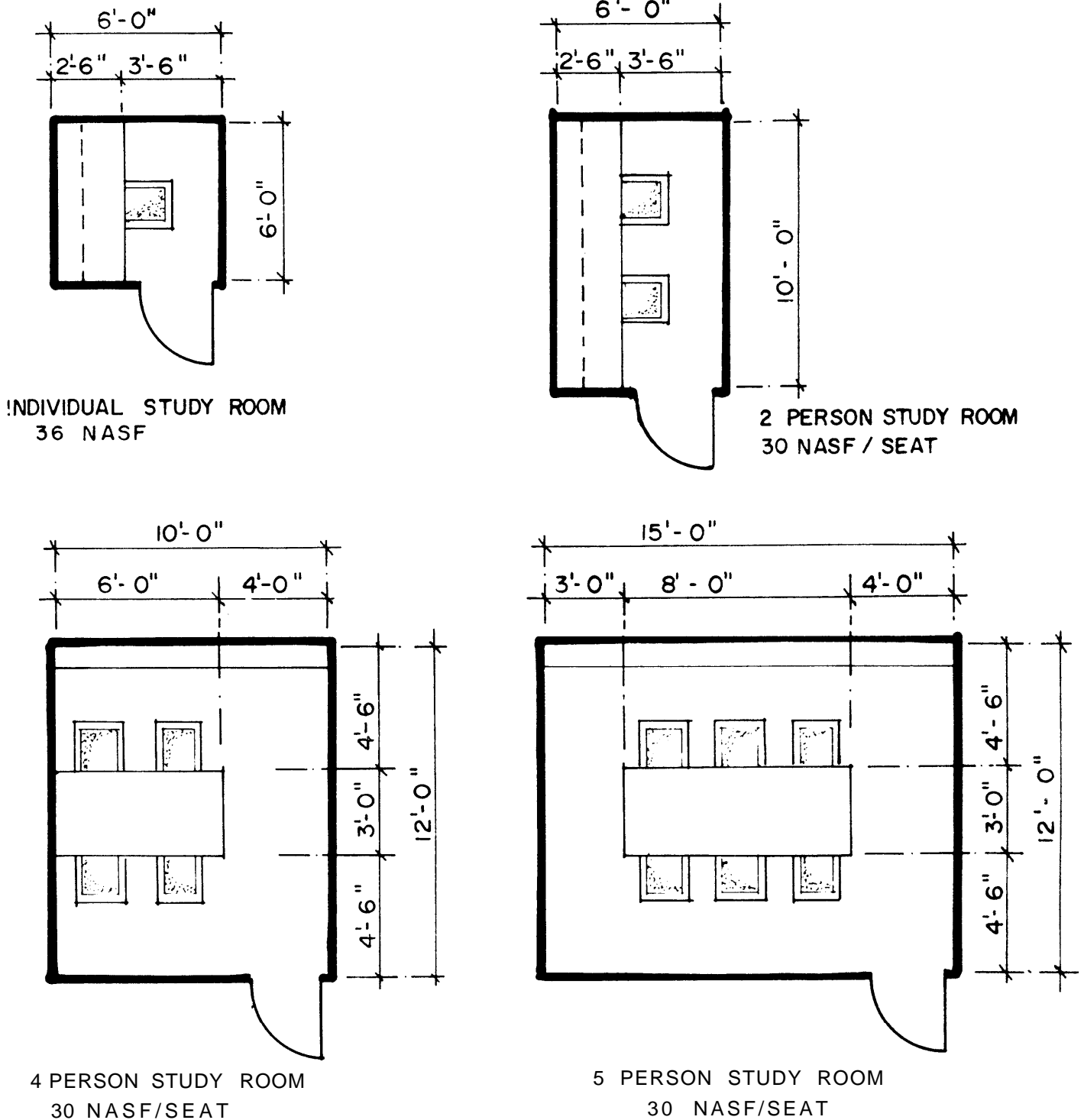

FIGURE 3-17

(3) *Microform Seating.* Seating must be provided for reader printer stations in libraries with microform collections. These should be similar in nature to carrel seating with the exceptions that reader/printer equipment

requires more space and microform seating should be isolated for either reading or study areas due to the noise generated by the reader/printer equipment. Microform seating requires 30 SF/seat. (See Fig. 3-18.)

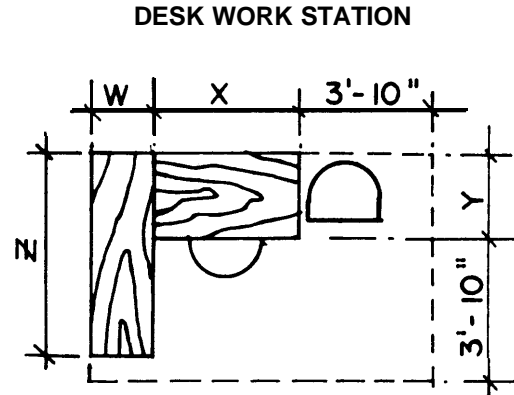
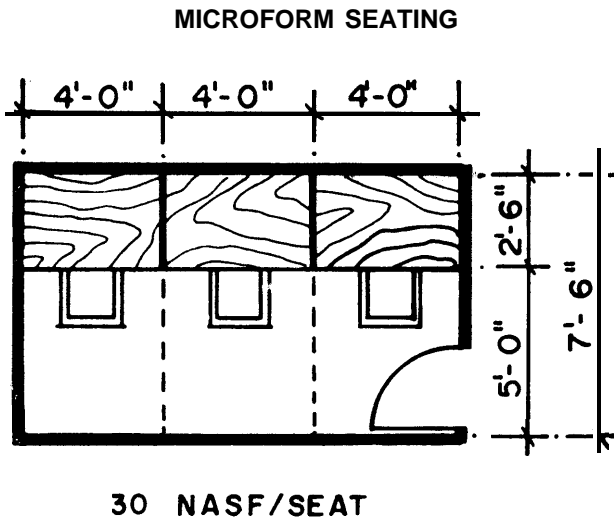

FIGURE 3-19

FIGURE 3-18

3-4 STAFF WORK STATION EQUIPMENT

a. DESKS

(1) *Office.* Desks are appropriate work stations for most administrative and service activities. They come in a variety of sizes and, when functionally required, can be furnished with side credenzas for typing or writing. (See Fig. 3-19 and Table 3-3.)

(2) *Control Desk.* The size and type of the control desk will vary depending on size and type of library. The control desk is usually composed of modular units which have nearby storage facilities for recordings, tapes, etc., and provide for a typing facility, files, and some locked storage space. The control desk modular units are normally 36 inches wide, 27 1/2 inches deep and 39 inches high for standing and 32 inches high for sitting. If standing height units are used, drafting-type stools should be provided and secretarial chairs should be utilized for sitting height control desks. The number of modular units required will depend on the functions, size, and type of library facility. Each unit requires 30 square feet except for corner units which require 10 square feet. The types of modular units normally available, each of which is 36 inches wide, 27 1/2 inches deep and 32 inches or 39 inches high, are shown in Figure 3-20. Requirements for control desks for smaller facilities are shown in Figure 3-21.

**TABLE 3-3 SPACE REQUIREMENTS-
STAFF WORK STATIONS**

Type	Ht.	W	X	Y	Z	NASF
Executive	30		72	36		67
Large Double Pedestal	30		72	30		62
Standard Double Pedestal	30		60	30		56
Single Pedestal	30		40	30		45
Typing	26		40	30		45
Computer	30/33	36	45	30	36	67
Credenza, if required	26/30	18			66	87

See Figure 3-19 for Area W, X, Y, and Z.

MODULAR CONTROL DESK UNITS

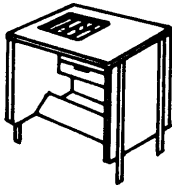

Station/Charge Unit: Same as station unit with open well for 3" wide cards.

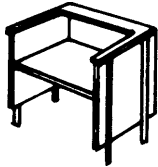

Typewriter Unit: Same as desk unit (c) but with 26" high top.

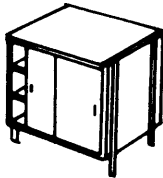

Cabinet Unit: Has side-sliding panel door.

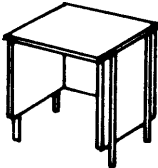

Truck Port: Accommodates book truck under unit.

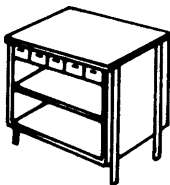

Card File Unit: Has five or ten or fifteen standard card trays for 5" wide cards and shelves below.

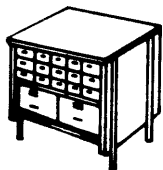

Card/Legal File Unit: Has card trays and legal file drawers.

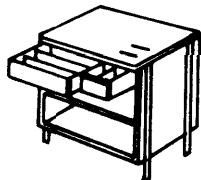

Charge Unit (Drawer Type): Has trays for 3" or 5" wide cards and four card drop slots.

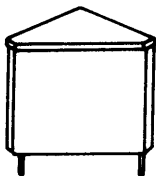

Corner Units.

FIGURE 3-20



Desk Unit: Provides 29" desk surrounded by 39" high assembly for continuity with other control desk units.



Charge Unit: "Well-type" with removable cover and trays for 3" cards.



Open shelving Unit: Has adjustable full-depth shelves.

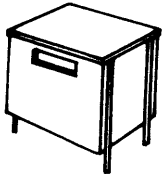

Book Return Unit: Used with depressable book truck.

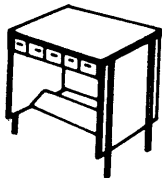

Station/Card File Unit: Same as card file but with no shelf below.

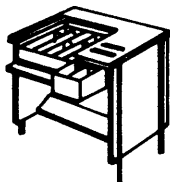

Station/Charge Unit (Well Type): Has removable cover, trays for 3" wide cards and may have drop slots.

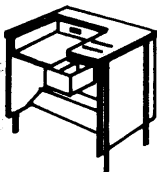

Station/Charge Machine Unit: Has 4 card drop slots and electric receptacle.

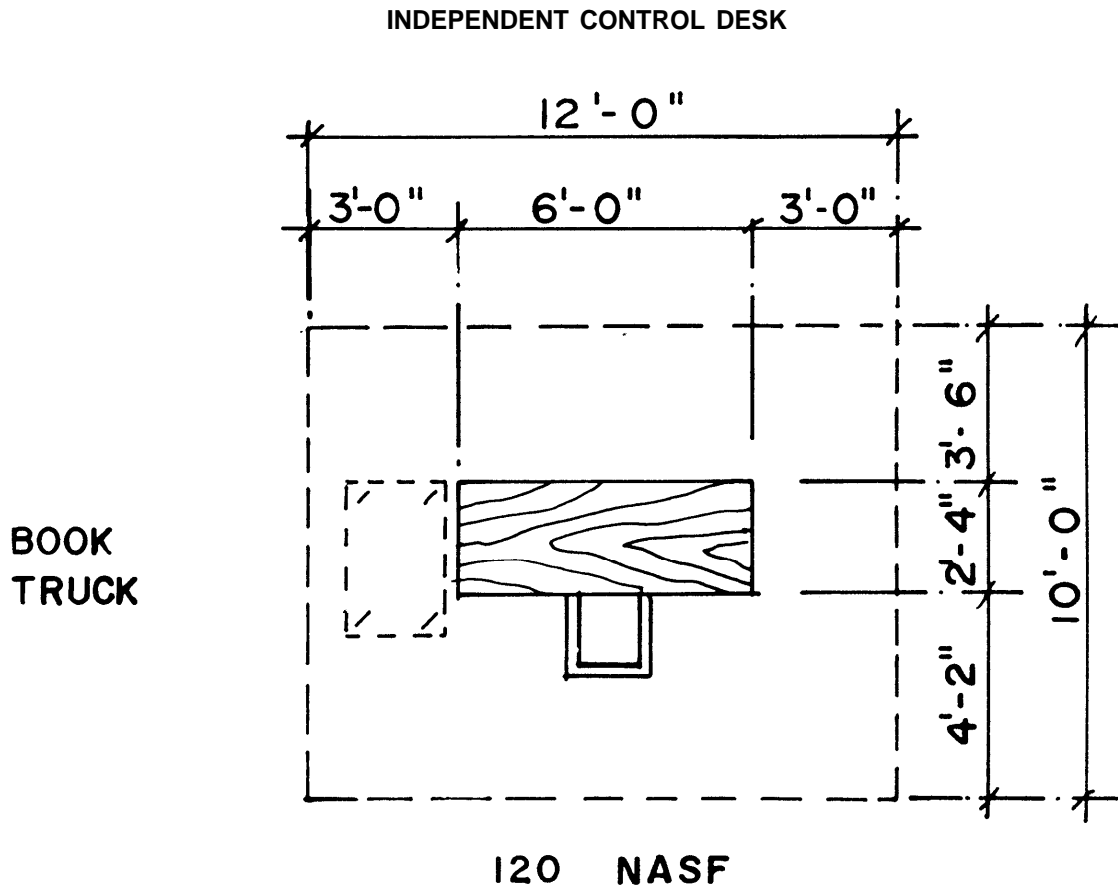

FIGURE 3-21

b. FILE CONTAINERS

(1) *Correspondence.* Correspondence files come in two basic sizes: standard and legal; and in two types: vertical and lateral. Space requirements are discussed in paragraph 3-2.c.

(2) *AV Materials.* See paragraph 3-2g.

(3) *Card Catalog.* Table 3-4 illustrates the card capacity for standard card cabinets. One inch of filing space generally accommodates 100 cards. The cabinets are 5 or 6 trays wide and 7 to 8 trays high. A 5-tray wide cabinet will fit into a standard 3-foot wide stack unit, but may be more expensive than a 6-tray wide cabinet. Trays should be 15 inches to 19 inches deep. Shorter trays are uneconomical; longer trays are too heavy. Critical dimensions for card

catalogs are shown in Figure 3-22. Catalogs are limited to 48 inches in height to allow use by physically handicapped personnel. Allow 17 NASF per unit.

**TABLE 3-4 CARD CAPACITY
 FOR STANDARD CARD CABINETS**

Trays	Tray length 17 inches	Height
15	19,500	30 inches
30	39,000	45 inches
42	42,000	48 inches

CARD CATALOG FILES

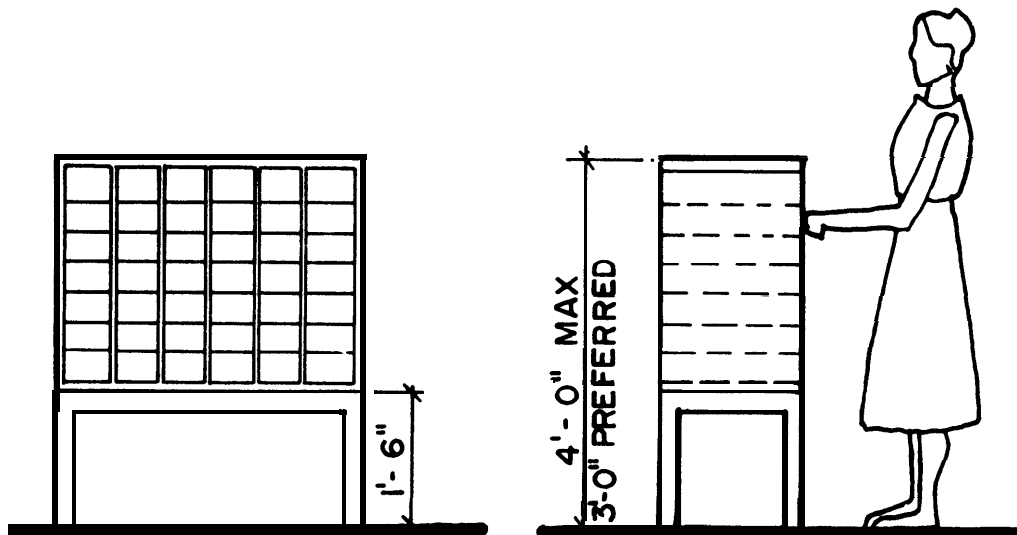
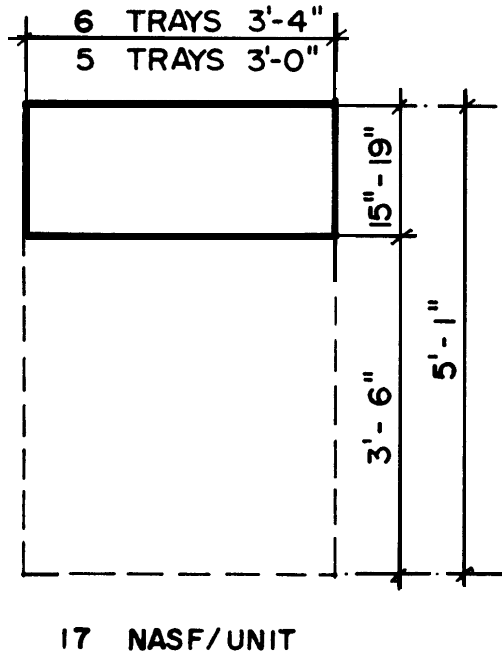

FIGURE 3-22

c. SHELVING

(1) *Stationary Shelving.* See paragraph 3-2a.

(2) *Mobile Shelving.* Mobile utility shelving is used in workrooms for moving large quantities of library materials between work stations. Units are 71 inches high by 48 inches wide by 19 inches deep and require 11 SF/unit for storage.

(3) *Compact Shelving.* Movable track-mounted compact shelving is used to store large amounts of library materials in small areas of work rooms. Each double-faced unit is 84 inches high by 37 inches wide by 26 inches deep and will hold 250 books or 100 boxes of paperback kits. Each unit requires 15 NASF for storage. Add an additional 25 NASF for each access space required. (See Fig. 3-23.)

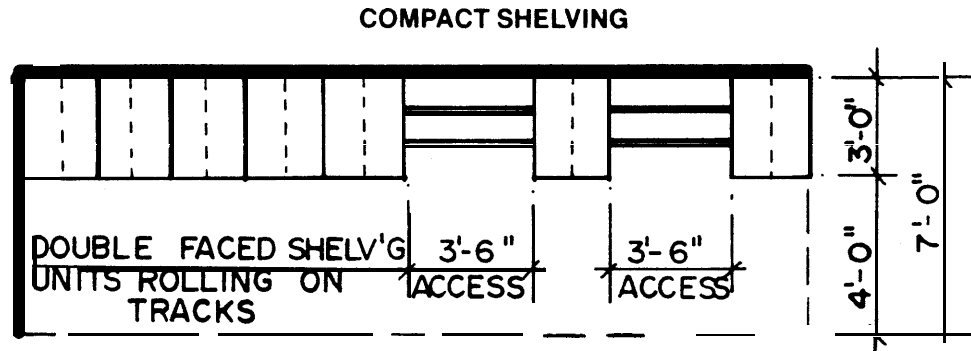

FIGURE 3-23

(4) *Book Trucks*. Book trucks come in two or three shelf models approximately 26 inches long by 18 inches wide by 42 inches high including casters. Depressible models are available for use with book drops, measuring 30 inches long by 22 inches wide by 29 inches high. Provide 9 NASF for storage of each truck.

d. TABLES

(1) *General Purpose*. See paragraph 3-3.a.(1). Tables provide a functional work station for a variety of activities. In the work station context tables should be programmed on the basis of whole work surfaces devoted to a set of specific activities rather than on the basis of seats available. They normally form a part of a larger work station for a single individual. Tables are usually 29 inches

high and are available in 24, 30, 36, and 48 inch widths and lengths of 48, 60, 72, 84, 90, and 96 inches. Table requirements may be estimated by considering the size of work surface required and the number of sides requiring access. For access on one side, multiply the area of the table by 2; for access on two sides, multiply by 3; for three sides, multiply by 4; and for 4 sides use a factor of 5.

(2) *Catalog Reference*. Tables for use with card catalogs are generally 42 inches high and have racks mounted on the bottom for call slips. Catalog reference tables are 24 inches wide and 72 inches or 102 inches long, requiring 96 or 116 NASF, respectively. They should be estimated on the basis of 24 NASF per user. (See Fig. 3-24.)

CATALOG REFERENCE TABLE;
4-STATION

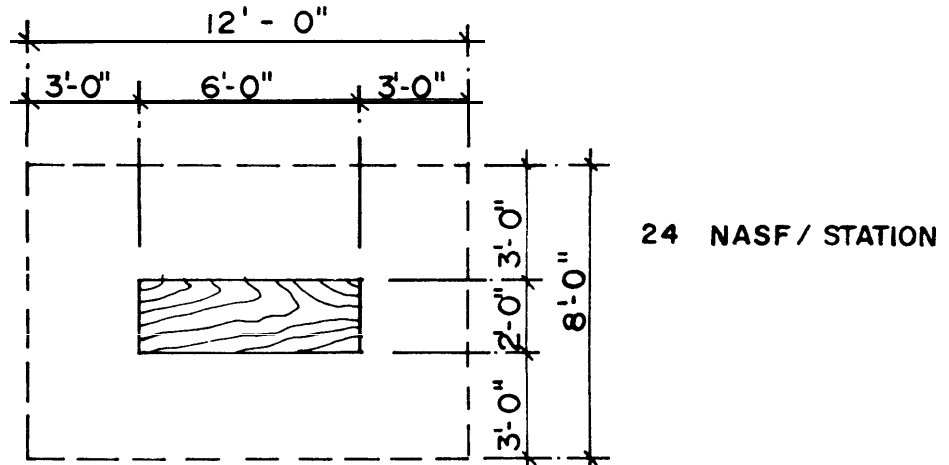

FIGURE 3-24

(3) *Work Counters*. Work counters are usually 42 inches high and are provided with either bins or shelves beneath. The size of work counter depends on the activity served and the area requirement should be multiplied by the appropriate factor for access listed in paragraph 3-4.d.(1)

(4) *Drafting*. Drafting tables are required for preparation of posters and audio-visual materials. A 40-inch by 60-inch table is adequate for most library requirements. Provide 60 NASF per drafting table. Space for a 30-inch by 60-inch reference table should also be provided. (See Fig. 3-25.)

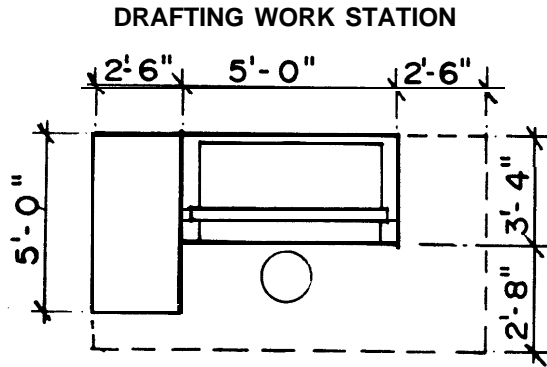
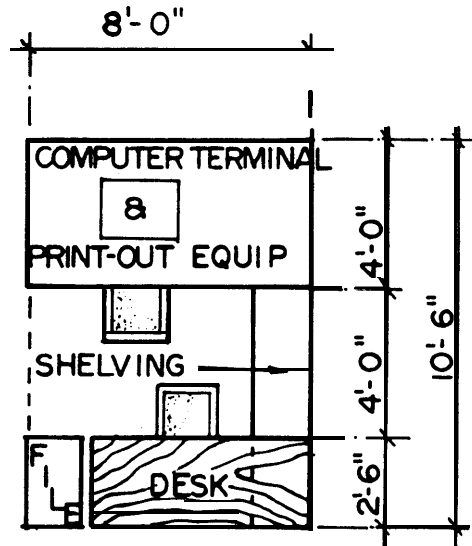

FIGURE 3-25

(2) *Computer Terminals.* Work stations for computer terminals for bibliographic and cataloging searches require an area of 84 NASF which includes a work table (4 feet by 8 feet) for computer terminal print-out-equipment and chair, a secretarial desk with typing facility and chair, file cabinet, and low shelving. (See Fig. 3-27.)

WORK STATION
COMPUTER TERMINAL



84 NASF

FIGURE 3-27

e. MISCELLANEOUS EQUIPMENT

(1) *Copy Machine.* Copy machines are required in most libraries to allow distribution and documentation of information while keeping the original document on hand. Copy machines should be separated acoustically from the remainder of the library but should be located near the control desk and the reference librarian. A separate copy machine should be located in the service area. Allow 60 NASF per unit. (See Fig. 3-26.)

COPY MACHINE

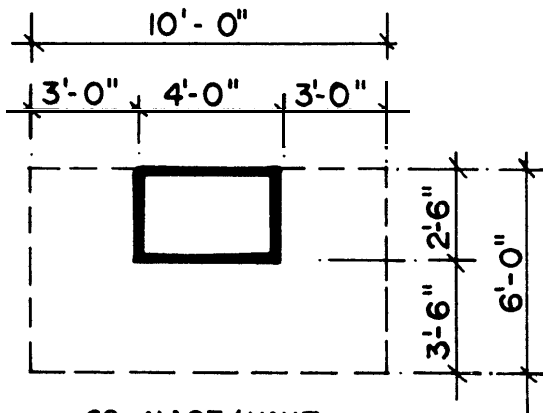

60 NASF/UNIT

FIGURE 3-26

(3) *Teleconference*. This activity requires space for two facsimile machines, two telephones, a TV camera, a TV monitor, and a TV print-out copier. This equipment can be accommodated on a 36 inch by 60 inch table with an 18 inch by 66 inch credenza. Allow 55 NASF. (See Fig. 3-28.)

(5) *Kitchen*. Compact kitchen units are often required for lunch rooms, lounges or conferences. Units should contain a two-burner range, under-counter refrigerator, microwave oven, counter, sink, and cabinets. Units are 60 inches wide by 26 inches deep by 87 inches high and require 40 NASF each. (See Fig. 3-30.)

TELECONFERENCE STATION

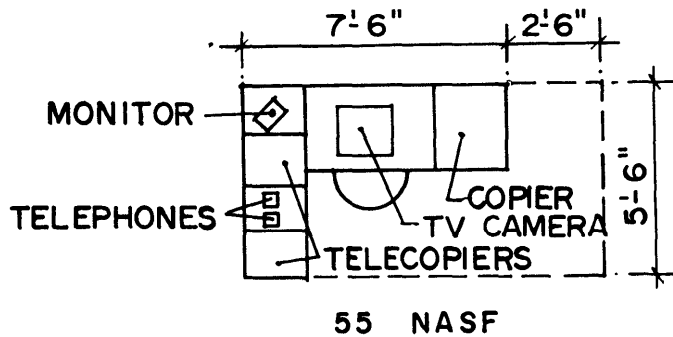
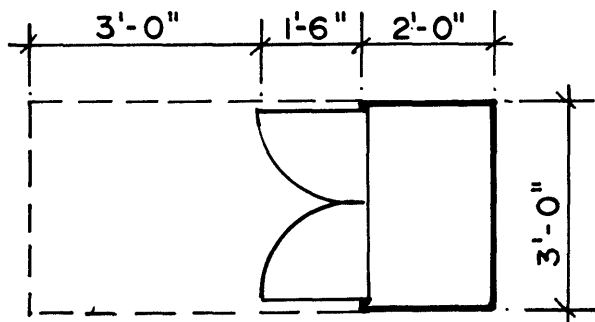

FIGURE 3-28

(4) *Supply Cabinets*. Supply cabinets are 36 inches wide by 24 inches deep and 78 inches or 42 inches high. Allow 20 NASF. (See Fig. 3-29.)

SUPPLY CABINETS



20 NASF

FIGURE 3-29

COMPACT KITCHEN UNIT

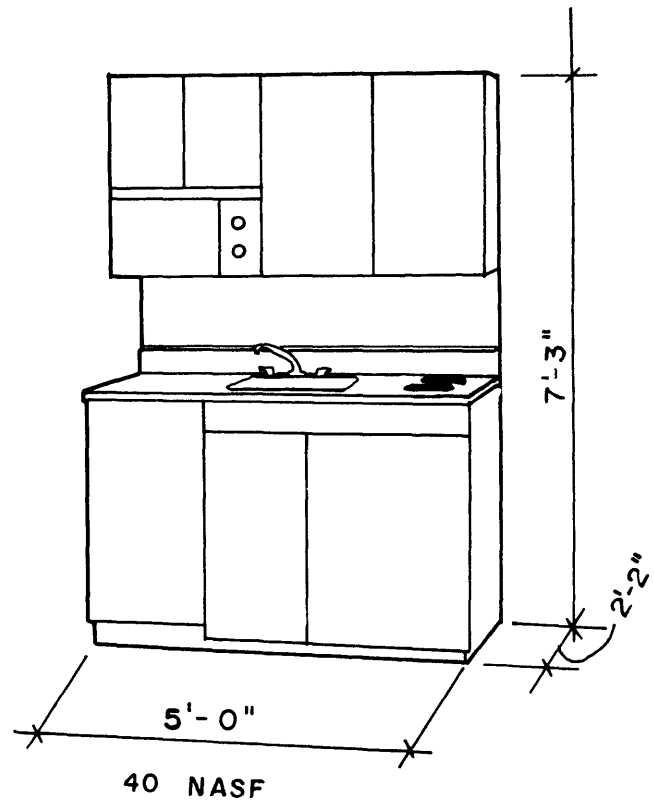

FIGURE 3-30

CHAPTER 4

Individual Space Criteria

This chapter presents requirements and design criteria for individual spaces. Each space is described in terms of activities, participants, adjacencies, and special considerations, as appropriate. The NASF requirement allocated to each space is indicated wherever possible.

- 4-1 Entrance and Lobby
- 4-2 Multi-Purpose Room
- 4-3 Public Toilets
- 4-4 User Card Catalog
- 4-5 Control Area
- 4-6 Reference Area
- 4-7 Current Periodicals Area
- 4-8 Microform Area
- 4-9 Stack Area
- 4-10 Reading and Study Areas
- 4-11 Conference Rooms
- 4-12 Study Rooms
- 4-13 Typing and Listening Rooms
- 4-14 Children's Area
- 4-15 Administrative Staff Offices
- 4-16 Technical Services Work Station
- 4-17 Shipping and Receiving
- 4-18 Staff Lounge
- 4-19 Staff Toilets and Lockers
- 4-20 Janitor's Closet
- 4-21 Environmental Criteria

Spaces which are unique to a special library type are listed in the Individual Space Criteria sections of the specific facility types in Chapters 6 through 12.

4-1 ENTRANCE AND LOBBY

A lobby is normally provided in libraries which are independent buildings and in larger libraries which are part of other facilities. The lobby serves as a transitional space between the outside and the library. It functions as a waiting lounge, an acoustical barrier, a circulation hallway, and a display area. General information concerning the library is provided there and frequently an after-hours bookdrop.

a. **ADJACENCIES.** If the library is an independent building, the entrance and lobby should be convenient to the parking area as well as the street, because most patrons will arrive by automobile. If there are two entrances to the lobby, one should be from the parking lot and the other from the street or sidewalk. The lobby should be adjacent to the library control entrance and it is desirable to have the staff entrance and toilets located adjacent to the lobby. If the library is part of a larger facility, the lobby would become a vestibule to increase acoustic isolation of the library from busy corridors.

b. SPECIAL CONSIDERATIONS

(1) *If Main Entrance Opens to Outdoors.* In most climates a vestibule is required to prevent heat gain in summer and/or heat loss in winter. Lobby lighting should be adjustable to permit an intermediate light level between outdoors and the interior of the library during day and nighttime operation.

(2) *Doors.* Any door between heavily trafficked areas should be at least one-third glass for safety. Glass doors with locks are suggested for the main entrance and between lobby and user areas except toilets. (Ref E-1a) Floor panels that automatically open entrance and exit doors should be considered for libraries whose users frequently enter and exit with armloads of books and materials and whose (Ref E-1a) users will include the physically handicapped.

c. FINISHES

Floor: mats, quarry tile, terrazzo, vinyl tile

Walls: brick, wallboard, plaster, concrete block, acoustic treatment, exposed tackboard, paint, vinyl covering

Ceiling: acoustical tile, exposed

d. **SPACE REQUIREMENTS.** Space requirements depend on a variety of factors. A lobby may not be needed in a small facility, especially if the library is part of another building. The required area will depend on the number and kind of spaces which open onto the lobby, and the anticipated traffic flow. For planning purposes, consider 5 percent of the NASF to be devoted to the lobby. Lounge seating: 30 NASF/seat.

4-2 MULTI-PURPOSE ROOM

The multi-purpose room serves as a conference and meeting room for classes, movies, and special interest groups. It is normally part of a main post library, but also may be included in branch libraries. It contains some of the general reading seats. It may also serve as a music-listening lounge and as an extension of the general reading area.

a. **ADJACENCIES.** Refer to discussions in Individual Space Criteria in Chapters 6 and 7.

b. **SPECIAL CONSIDERATIONS.** Provide projection screen for slides and movies, and provide locked cabinets for audio-visual equipment storage. Provide space for portable chairs for classes.

c. FINISHES

Floor: carpet
 Walls: brick, architectural materials, painted wall-board or plaster or concrete block, vinyl wallcovering, tackboard, acoustic treatment as required
 Ceiling: acoustical tile

d. SPACE REQUIREMENTS

Item	Unit Area Allowance/NASF
Lounge Seating	30 per seat
Table and Chairs	25 per seat
Portable Seating	20 per seat
	(0.4 NASF/seat stacked)

4-3 PUBLIC TOILETS

These facilities are intended for library users in the larger facilities and for users and staff in smaller facilities.

a. ADJACENCIES. Public toilets should be located within 25 feet of entrance to the library and adjacent to the lobby, if a lobby is provided.

b. FINISHES

Floor: ceramic tile, quarry tile, terrazzo
 Walls: brick, architectural materials, ceramic tile wainscot, wallboard, plaster, concrete block, paint, vinyl covering
 Ceiling: acoustical tile, wallboard, plaster

c. SPACE REQUIREMENTS. Space requirements for public toilet areas are based on (a) occupancy as determined by the number of library reader stations provided, not including portable seating or lobby seating; and (b) fixture allowances given in Table 10-7 of DOD 4270.1-M. These space requirements apply when the number of adult male users equals the number of adult female users, and when the number of user seats for each library size is in accordance with the number suggested in this guide. If the anticipated user population is significantly different from 50 percent male and 50 percent female, the fixture allocation should be adjusted in accordance with Table 10-7 of DOD 4270.1-M.

Table 4-1 indicates number of fixtures by type and area per fixture unit for both men and women based on various magnitudes of occupancy.

PUBLIC TOILET FIXTURE REQUIREMENTS BASED ON USER POPULATIONS

TABLE 4-1. PUBLIC TOILET FIXTURE REQUIREMENTS BASED ON USER POPULATION

Items	Typical Occupancy	30 Men		51 Men		90 Men		103 Men		121 Men		150 Men	
		30 Women	51 Women	51 Men	90 Women	103 Women	121 Women	150 Women					
	Unit Area Allowance	QTY	NASF	QTY	NASF	QTY	NASF	QTY	NASF	QTY	NASF	QTY	NASF
Men													
WC	25	2	50	3	75	5	125	5	125	5	125	6	150
Urinals	25	1	25	2	50	3	75	3	75	3	75	3	75
Lavatories	15	2	30	3	45	5	75	5	75	5	75	6	90
Women													
WC	25	2	50	4	100	6	150	6	150	6	150	6	150
Lavatories	15	2	50	4	60	6	90	6	90	6	90	6	90

TABLE 4-1

d. SPECIAL CONSIDERATIONS. Provide for the physically handicapped in accordance with EM-1110-1-103. The toilet room layout plans shown below graphically indicate the governing critical dimensions which must be provided

in order to provide accessibility to the physically handicapped. An additional unit area allowance of 17 SF/WC for use by handicapped should be provided. (See Fig. 4-1.)

TOILET AREA CRITICAL DIMENSIONS

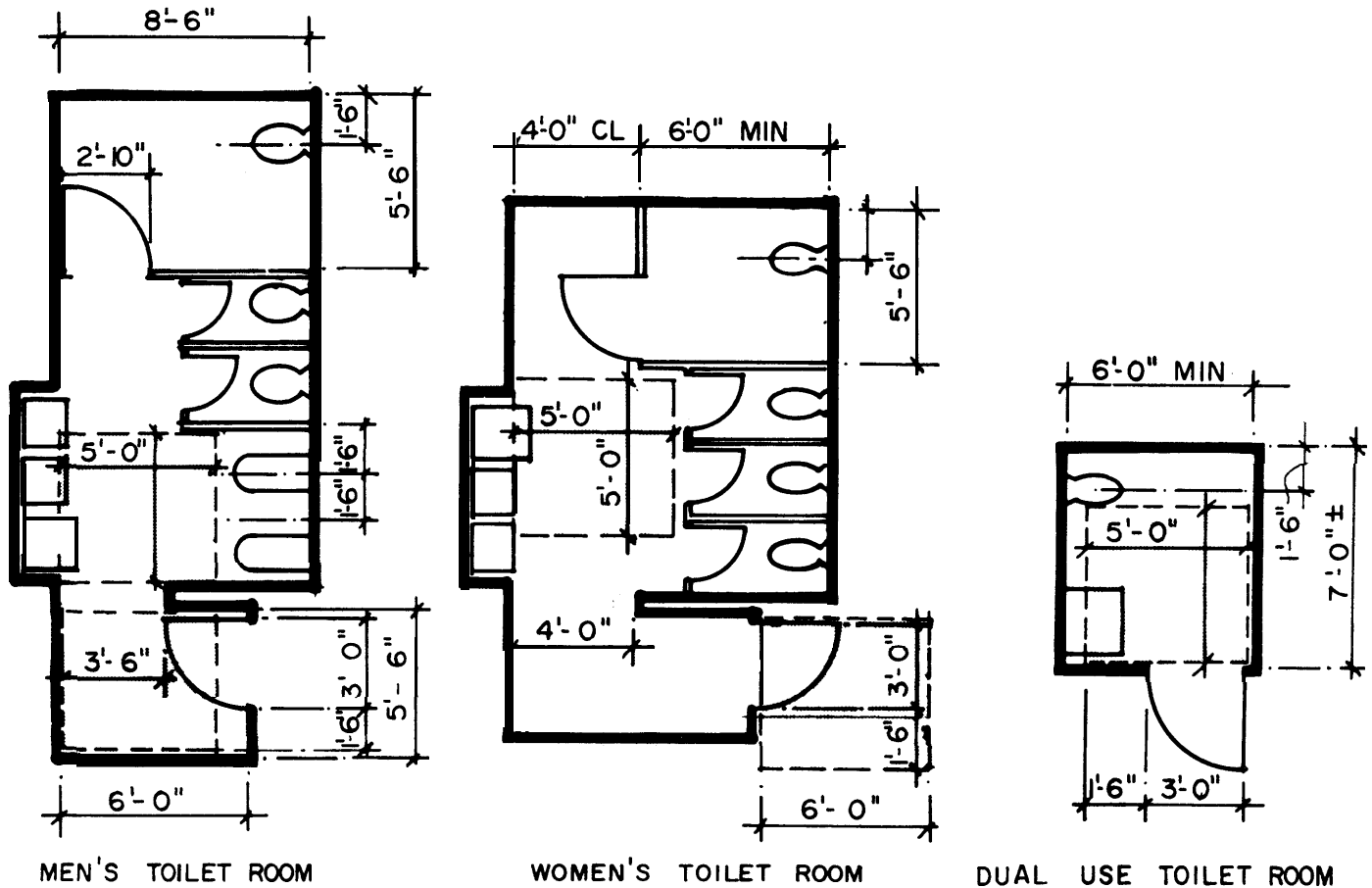

FIGURE 4-1

4-4 USER CARD CATALOG

This card catalog is used by patrons and staff to locate materials and is maintained by Technical Services personnel.

a. ADJACENCIES. If possible, the card catalog should be adjacent and visible from control and reference areas, centrally located, and easily accessible from technical services, general reading area, book stacks, and periodical area.

b. SPECIAL CONSIDERATIONS. Refer to the discussion of card catalog capacity in paragraph 3-4b(3). The unit should be no more than 48 inches high to allow use by

handicapped in wheelchairs. If a computer terminal is used to replace the standard catalog, provide a telephone outlet, table, and chair for each terminal.

c. FINISHES

- Floor: replaceable carpet, vinyl tile
- Walls: brick, architectural materials, wallboard, plaster, concrete block, acoustic treatment, paint, vinyl covering
- Ceiling: acoustic tile

d. SPACE REQUIREMENTS. Allow 17 NASF per unit. (See Fig. 4-2)

CARD CATALOG EXAMPLE LAYOUTS

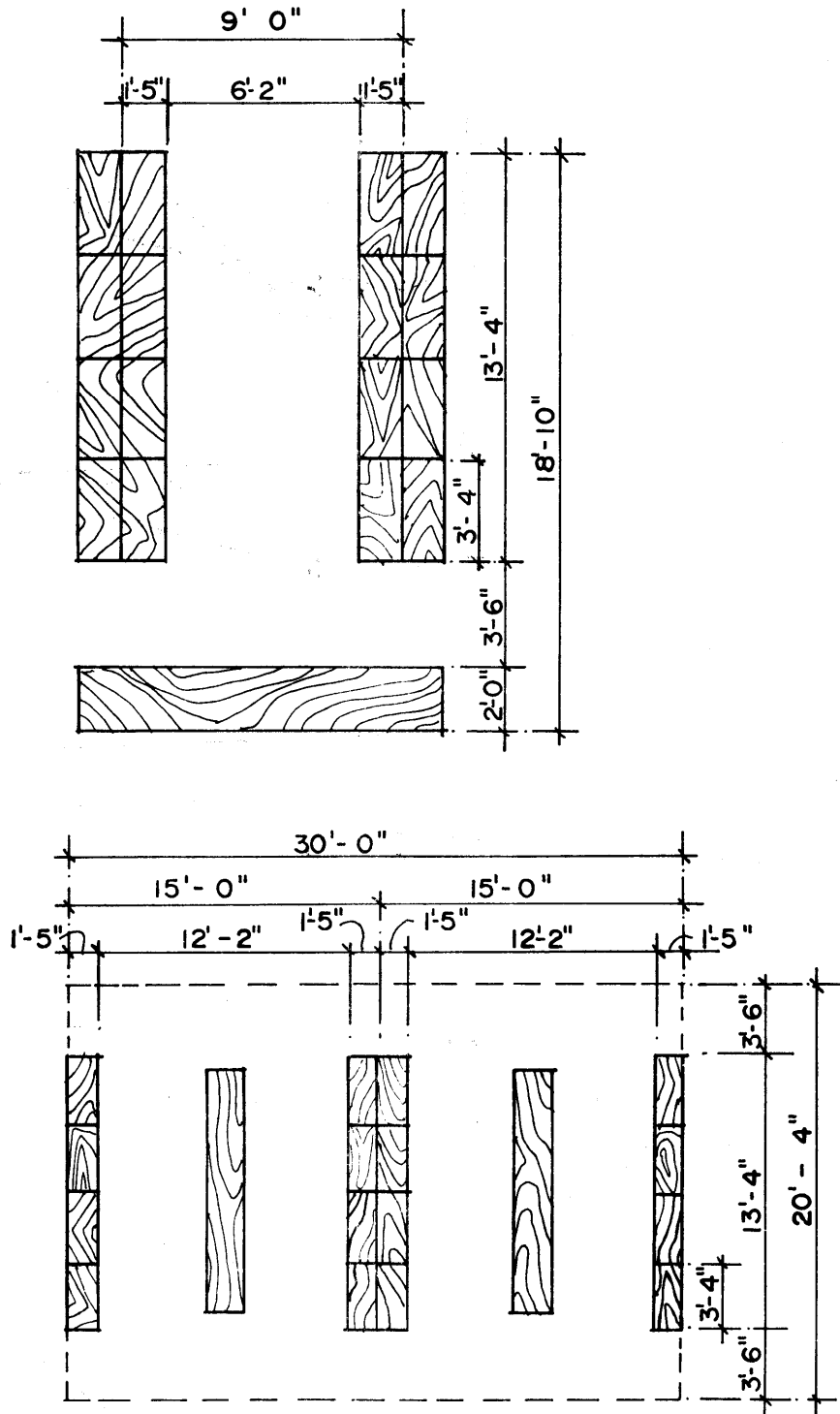

FIGURE 4-2

4-5 CONTROL AREA

All patrons using or borrowing library materials must pass through this area. Personnel at the control (circulation) desk check materials in and out, monitor circulation and provide general library information. In small libraries, with one or two staff members, the control desk may also serve as the librarian's work area and any necessary technical services will be performed here. In large libraries, several staff members may work behind the control desk.

a. **ADJACENCIES.** Control desk personnel should have visual control of as much of the user area as possible. The control area must be adjacent to the entrance and lobby. The technical services area should be located in close proximity to the control desk so that technical services personnel can operate the control desk, if necessary. The public card catalog should be visible from the control area, if possible.

b. **SPECIAL CONSIDERATIONS.** In large libraries, provide a replaceable carpet to a distance of 12 feet around the control desk. A lowered ceiling or other acoustic provisions should be provided to control noise generated by the electric charging equipment if user seating areas are nearby. Allowance should be made for provision of computer terminal and printer in the control area. This will include such requirements as dedicated telephone line(s) and additional electrical service as well as additional floor area to house the computer hardware.

In addition to the control desk, the control area usually makes some provisions for shelving for reserve books, recordings and other materials. In addition, the control area may provide for a small work area behind the desk for maintenance files used at the control desk, processing of overdue materials, and for making minor repairs to materials. A copy machine may also be located in the control desk area. Work area and copy machine allowances will be dependent on type and size of the library facility.

c. **FINISHES**

- Floor: carpet
- Walls: painted wallboard, plaster or concrete block, special finish materials
- Ceiling: acoustical tile, lowered ceiling optional

d. **SPACE REQUIREMENTS**

<u>Item</u>	<u>Unit Area Allowance/NASF</u>
Control Desk	30/module
Work Counter	5 NASF/linear foot of counter
Files	10
Book Trucks	9
Copy Machine	60
Single-Faced Shelving	13
Computer Terminal	84

4-6 REFERENCE AREA

Reference materials are non-circulating and are normally used in the immediate area. A reference librarian may be located in the area to answer questions and research information.

a. **ADJACENCIES.** The reference area should be as close to the control area as possible so that control desk personnel can assist patrons in the absence of a reference librarian. The public card catalog should be adjacent to this area if possible. User seating should be in close proximity to reference shelving. The microform area should be adjacent for access to archives and technical data systems.

b. **SPECIAL CONSIDERATIONS.** Reference books tend to be large, and often many are used at a time. Therefore, tables should be 4 feet wide and provide 3 linear feet per person. In some larger libraries and special libraries, allowance should be made for provision of a computer/computer terminal and printer in the reference area. This will include such requirements as dedicated telephone line(s), additional electrical service, and temperature controls for computer equipment as well as additional floor area to house the computer hardware.

c. **FINISHES**

- Floor: carpet
- Walls: vinyl covering or printed wallboard, plaster or concrete block
- Ceiling: acoustical tile

d. **SPACE REQUIREMENTS**

<u>Item</u>	<u>Unit Area Allowance/NASF</u>
Shelving	9
Reference Librarian	125
Index Table	25/seat
Lounge Seating	30
Computer Terminal	84
Map Case	40
Atlas Case	25
Dictionary Stand	25
Globe Stand	25
Table Seating	25/seat
Research Carrel	40

4-7 CURRENT PERIODICALS AREA

Provides shelving for periodicals up to about one year. Older issues are boxed or bound and shelved in the stack area or are held on microfilm. Includes lounge and table seating.

a. **ADJACENCIES.** May be separated from adult user areas, if necessary, in a multi-story scheme. Should be close to reference area.

- b. FINISHES
 - Floor: carpet
 - Walls: painted wallboard, plaster or concrete block, or vinyl covering
 - Ceiling: acoustical tile
- c. SPACE REQUIREMENTS

Microfiche Storage Unit, to accommodate 40,000 cards 10

4-9 STACK AREA

Stack areas are for storage of the general library collection. In non-classified collection, browsing may be allowed.

a. SPECIAL CONSIDERATIONS

(1) Stacks should be oriented so that personnel can see down the aisles from their work stations, if possible.

(2) Ceiling lighting fixtures parallel to the stacks provide better lighting than fixtures perpendicular to the stacks, but cause problems if stack spacing is subsequently changed. If future change in stack spacing or location is a reasonable possibility, lighting fixtures should be oriented perpendicular to the shelving or modular light fixtures should be used that can be relocated with the stack.

(3) Passage lanes between fixed stacks shall be a minimum width of 3 feet 6 inches as shown in Figure 3-3.

(4) Major circulation paths between and around stack area should be 60 inches wide to permit passage of two wheelchairs.

b. FINISHES

- Floor: carpet/resilient tile
- Walls: painted wallboard, plaster or concrete block, or vinyl covering
- Ceiling: acoustical tile

c. SPACE REQUIREMENTS

Single-Faced Sections: 13 NASF/section for sections 8-12 inches deep
 Double-Faced Sections: 9 NASF/section for sections 16-24 inches deep

4-10 READING AND STUDY AREAS

These areas include seating for study, browsing, and research.

a. ADJACENCIES. Reading study area should be adjacent to or dispersed within the stack area. They should be within 50 feet of the card catalog and reference collection.

b. SPECIAL CONSIDERATIONS. Provision should be made in selected study carrels for a computer terminal. This will require provision of 220V electrical service to the area and temperature control as well as provision of the requirements for dedicated telephone lines and space for location of computer hardware.

c. FINISHES

- Floor: carpet
- Walls: painted wallboard, plaster or concrete block, or vinyl covering
- Ceiling: acoustical tile

<u>Item</u>	<u>Capacity</u>	<u>Unit Area Allowance/NASF</u>
Display Shelving, back issues behind current	15 titles	9-13½*
Display Shelving, back issues under current	15 titles	9-13½*
Shelving, no display	75 titles	9-12½*
Display Rack—4 ft W, 5 ft H, 20 in. D	28 titles	35
Newspaper Rack, table type		17
Lounge Seating		30
Table Seating		25/seat

*Use lower figure for configuration similar to stack area with units double faced 5 feet. Use higher figure for wall shelving or widely spaced double faced sections suitable for browsing.

4-8 MICROFORM AREA

This area is for the use and storage of microfilm and microfiche, and includes readers, reader-printers, and storage.

a. ADJACENCIES. In libraries with small microform collections, the microform area may be included as part of the current periodicals area or at the control desk. For libraries with a large microform collection, the microform area may be a separate room, or at least physically separate from the current periodicals area, and should have adjacency to the reference area. If the microform collection consists mainly of back periodical issues, it should be near the portion of the book stacks which contain bound or boxed periodicals. If it contains classified documents, it is considered part of the classified collection for which criteria is presented in Chapter 12.

b. FINISHES

- Floor: carpet
- Walls: vinyl covering or painted wallboard, plaster or concrete block
- Ceiling: acoustical tile

c. SPACE REQUIREMENTS

<u>Item</u>	<u>Unit Area Allowance/NASF</u>
Microform Reader/Printer	28-38
Microfiche Reader/Printer	28-38
Microfilm Storage Unit, to accommodate 400 reels	15

d. SPACE REQUIREMENTS

<u>Item</u>	<u>Unit Area Allowance/NASF</u>
Table Seating	25/seat
Carrel Seating	30
Research Carrel	40
Microform/AV Seating	28-38
Typing	36
Lounge Seating	30

4-11 CONFERENCE ROOMS

Conference room (s) may be required for staff and/or public meetings. It may be advantageous to provide a multi-purpose room which serves functions other than conferences. Refer to Multi-Purpose Room criteria in paragraph 6-3b.

a. ADJACENCIES. Conference rooms intended primarily for staff use should be within staff area, but located so that non-staff members can enter without passing through staff work areas. Conference rooms intended primarily for users should permit users to enter and leave with minimal disturbance of reading and study areas. The access to the conference room should not permit users to exit with library materials.

b. SPECIAL CONSIDERATIONS. Provide chalkboard and tackboard. A projection screen should be considered, especially in larger conference rooms.

c. FINISHES

Floor: carpet or vinyl tile

Walls: vinyl wall covering; or painted wallboard, plaster or concrete block, tackboard, chalkboard, one wall glass curtain, daylight optional.

d. SPACE REQUIREMENTS. Allow 30 NASF/person

4-12 STUDY ROOMS

To provide acoustic isolation for typing, group discussions, or individual study and/or research.

a. ADJACENCIES. If the user group is primarily professional (scientific and technical libraries, medical libraries, law libraries, school libraries), study rooms may be anywhere within user areas. For other user groups (main post libraries, branch libraries), the entrance to study rooms should be visible from a staff work station. For classified collections, the study room must be provided for the user within the vault but with a distinct barrier between material and user.

b. FINISHES

Floor: carpet or vinyl tile

Walls: Painted wallboard or plaster or concrete block, or vinyl wall covering, tackboard, chalk-

board, one wall glass

Ceiling: acoustical tile

c. SPACE REQUIREMENTS. Allow 30 NASF/person

4-13 TYPING AND LISTENING ROOMS

These rooms provide acoustic isolation for individual use of typewriters, tape recorders, and other noisy equipment. They may be furnished with the equipment or the equipment may be borrowed from the control desk.

a. ADJACENCIES. These rooms should be visible from the control desk to preclude abuse of space. These rooms should generally be grouped together so that if some are occupied, the user need not search for an unoccupied room.

b. SPECIAL CONSIDERATIONS. Entrance doors should have windows. Additional windows to the interior or to the exterior are desirable to alleviate the possible claustrophobic feeling that small rooms cause some users. Keyed door locks should be provided.

c. FINISHES

Floor: carpet

Walls: painted wallboard, plaster or concrete block or vinyl wall covering, acoustical treatment, if necessary

Ceiling: acoustical tile

d. SPACE REQUIREMENTS. Allow 36 NASF/person

4-14 CHILDREN'S AREA

A children's area is normally provided in main and branch libraries. Larger libraries normally include a children's librarian on the staff.

a. ADJACENCIES. The children's area should normally be on the ground floor, convenient to the main entrance. The children's area should be monitored by and visible from the control area if there is no children's librarian. Children's toilets should be provided for children's areas which exceed 2000 square feet. An active area (generally 150-300 square feet) with space for floor cushions may be provided, but should be as remote as practicable from table seating.

b. SPECIAL CONSIDERATIONS. Table and lounge seating should occupy 20-25 percent of the NASF required for shelving. Provide at least one sloped-top reading table with chairs for small children. Storage should be generally about 2 percent of the total NASF. Children's shelves accommodate 85 volumes per unit at working capacity.

c. FINISHES

Floor: carpet

Walls: painted wallboard, plaster or concrete block or vinyl wall covering, tackboard

Ceiling: acoustical tile

d. SPACE REQUIREMENTS

Item	Unit Area Allowance/NASF
Shelving	9
Card Catalog	17
Children's Librarian	125
Lounge Seating	20
Table Seating	20/seat
Cushions	15
Boy's Toilet	50
Girl's Toilet	50
Storage: 2 percent	varies

Walls: painted wallboard, plaster or concrete block
 Ceiling: acoustical tile

c. SPACE REQUIREMENTS. Table 4-2 outlines space requirements for staff offices and work stations based on military rank or civil service classification only. This method establishes a general guideline for determining staff space requirements but must be adjusted according to functions performed on an individual basis. See AR 405-70. A closet or locker should be provided, if possible, in private offices for storage of personal items.

TABLE 4-2 STAFF OFFICE

Military Rank	Civil Service Classification	Office Area NASF
**General	GS-18	400
*General	GS-16 and GS-17	300
Colonel	GS-14 and GS-15	200
Lt. Colonel	GS-13	150
Major	GS-12	100
Captain	GS-11	90
1st Lt.	GS-9	80

4-15 ADMINISTRATIVE STAFF OFFICES

a. ADJACENCIES. The administrative staff area is generally located adjacent to the control area and technical processing area. If possible, visitors should have direct access to this area without passing through staff, reading or stack areas. Staff offices and work stations should generally be located off a staff circulation corridor, dependent upon size of staff and library and/or unless frequent public access is required. Work stations may be required adjacent to the stack area for users engaged in special projects, in reference areas, children's areas, or classified areas dependent upon the type of library, size, and/or level of service offered by a particular library facility.

b. FINISHES

Floor: carpet

Figure 4-3 shows suggested layouts for the various office sizes delineated in Table 4-2.

STAFF OFFICES AND WORK STATIONS

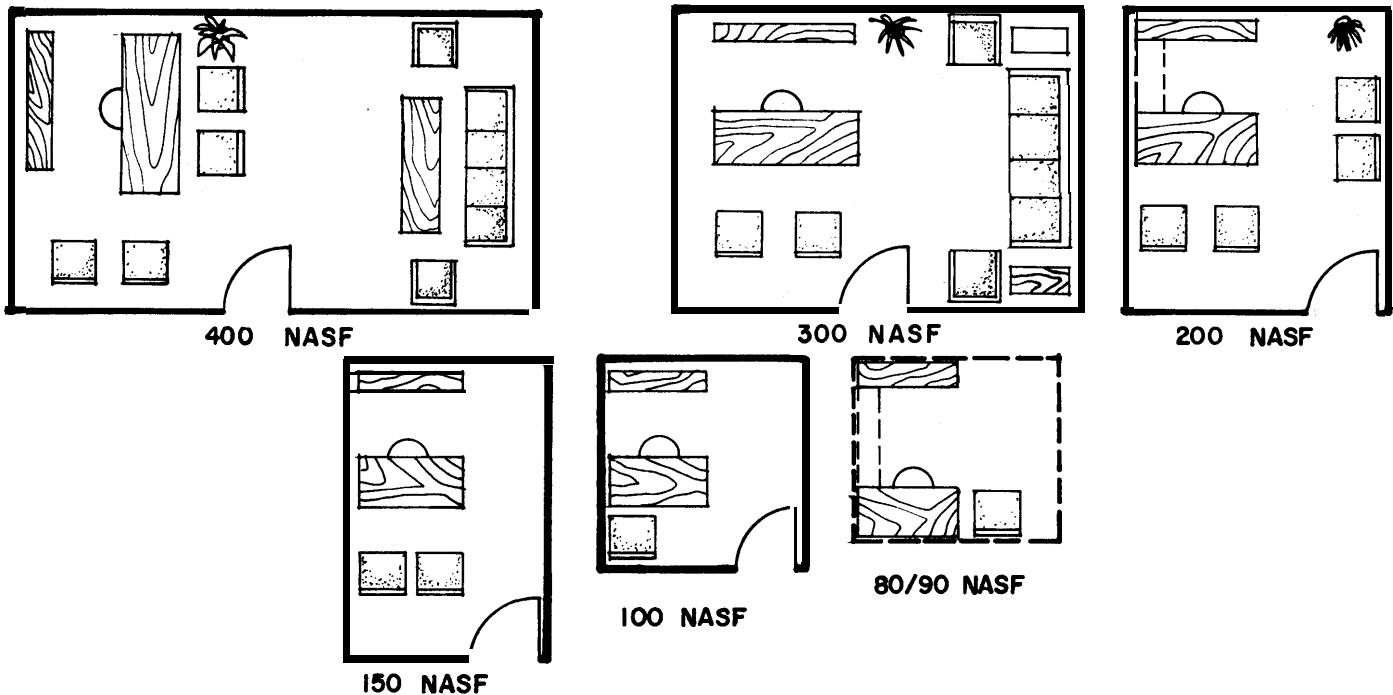

FIGURE 4-3

4-16 TECHNICAL SERVICES WORK STATIONS

Staff areas used for any of the following: order and acquisitions; descriptive and subject cataloging; classification; work with serials; physical processing; typing and clerical work.

a. **ACTIVITIES.** A layout based on work flow should be considered to maximize efficiency and communication of technical services. Following is a list of technical service activities.

(1) *Order and Acquisitions Area.* The order and acquisitions section is responsible for purchase requisitioning, ordering of books and periodicals, and supervision of shipping and receiving activities. This work is carried out by a librarian in a small technical services operation, but may be divided in large institutions into as many as five groups; selecting, ordering, checking in acquisitions, billing, and gift and exchange work. The order and acquisition area should be adjacent to shipping and receiving, if practicable.

(2) *Cataloging Area.* The cataloging process, whether automated or manual, consists of several operations. First, incoming materials must be checked to determine whether catalog cards are necessary. Where cataloging is necessary, materials will be checked against titles listed in the computer bank, if automation is available, and catalog cards will be ordered for these materials. Where automation is not available and/or titles are not listed in the computer bank, manual cataloging must be performed. Both operations require the use of book indexes and standard classification materials and the typing of catalog cards. Dependent upon the size and/or type of library facility, a professional librarian will usually be required for subject-heading work, classification, and description cataloging.

(3) *Physical Processing and Bindery Area.* The physical processing and bindery section prepares labels, book cards, and packets for library materials, and affixes plastic jackets. Materials which are to be sent for binding are prepared for shipment in this area. In larger libraries this may be a separate department. Since the amount of material in process varies at different times of the year, adjacent storage space is essential for this activity.

b. **ADJACENCIES.** The technical services area should be adjacent to the administrative offices and shipping and receiving and should be in as close proximity to the stack as practicable.

c. **FINISHES**

- Floor: generally vinyl tile, carpet in administrative areas
- Walls: Vinyl wall covering, painted wallboard, plaster or concrete block, tackboard
- Ceiling: acoustical tile

d. **SPACE REQUIREMENTS.** Space requirements for each member of the staff should be developed based on the equipment their duties require. Use NASF requirements shown in paragraph 3-4 for developing these work stations. In addition to individual work stations, the following joint-use equipment may be required:

<u>Item</u>	<u>Unit Area Allowance/NASF</u>
Files	10
Shelving	13
Mobile Shelving	11
Book Trucks	9
Card Catalog	17
Supply Cabinet	20
Index Table	150
Drafting Table	48
Work Counter (including sink)	5 per LF
Copy Machine	60
Computer Terminal	84

4-17 SHIPPING AND RECEIVING

A shipping and receiving area should be provided in all libraries for delivery and dispatch of books and other library materials. A majority of libraries will require loading dock capability somewhere in the building.

a. **ADJACENCIES.** The shipping and receiving area should be near the acquisition area (technical services), if practicable. The exit to the loading dock should be located to discourage unauthorized use by library patrons. Provide a buzzer or telephone at service entrance to alert technical services staff of delivery. Libraries which are part of large buildings need access to a service corridor and/or service elevator for delivery of materials to a receiving area.

b. **FINISHES**

- Floor: concrete or vinyl tile
- Walls: painted concrete block or vinyl wall covering
- Ceiling: acoustical tile

c. **SPACE REQUIREMENTS**

<u>Item</u>	<u>Unit Area Allowance/NASF</u>
Desk and Chair	50
Work counter	50 per full-time staff member
Storage bins	25 per bin
Loading dock	2.5 per linear foot outdoor, uncovered loading dock 5 per linear foot covered loading dock

4-18 STAFF LOUNGE

A staff lounge area should be provided for all libraries. In smaller libraries with a small staff, the staff lounge may be only an alcove in the technical services areas; in larger libraries, the staff lounge should be provided in a separate space. The size of the lounge area should be a function of staff size based on full-time equivalent (FTE) staff members. The staff lounge is used by staff members for eating, relaxation, and staff meetings. The staff lounge may also have limited use by the public for refreshments. Staff schedules frequently permit only short breaks for lunch, so that a kitchenette in the staff lounge for limited preparation/heating of food is desirable.

a. **ADJACENCIES.** The staff lounge should be located as close as practicable to staff work stations. It should be in close proximity to the technical service, administrative, and control desk areas.

b. **FINISHES**

Floor: carpet

Walls: brick, architectural materials, painted wallboard or plaster or vinyl wall covering, tackboard

Ceiling: acoustical tile

c. **SPACE REQUIREMENTS**

<u>Staff Members (FTE)</u>	<u>Lounge Area/NASF</u>
1-4	40 SF/staff member
5-9	300
10-14	400
15-20	500
above 20	(500 +20 SF/staff member over 20)

<u>Item</u>	<u>Unit Area Allowance/NASF</u>
Sofa	75
Lounge Chair	30
Chairs and Table	25/seat
Unit Kitchens	80

4-19 STAFF TOILETS AND LOCKERS

Staff toilets should be provided only if (1) public toilets are located more than 100 feet away from staff areas or (2), if the staff is large enough to warrant a separate toilet facility, or (3) if public toilets are restricted from use as in a classified collection. Lockers should be provided for all

staff members who do not have private offices for storage of coats and other personal belongings.

a. **ADJACENCIES.** Locate near the area of greatest staff concentration. Entrances should be remote from public toilet entrances. For economy, consider proximity to other areas that require plumbing. Lockers should be located in the staff lounge or the technical services area if a separate staff lounge is not provided.

b. **FINISHES**

Floor: ceramic tile, concrete, quarry tile, or terrazzo

Walls: ceramic tile wainscot with painted wallboard or plaster or concrete block above

Ceiling: acoustical tile

c. **SPACE REQUIREMENTS.** See paragraph 4-3 for development of space requirements for toilets. Allow 4 NASF per person for lockers.

d. **SPECIAL CONSIDERATIONS.** Handicapped persons shouldn't be required to travel more than 150 feet on any floor to reach an accessible toilet. Even though staff toilets may be provided, they do not necessarily have to be accessible if accessible public facilities are available within the travel limit. However, if single toilet rooms are provided in the staff area, they should be made accessible as prescribed in EM 1110-1-103.

4-20 JANITOR'S CLOSET

The janitor's closet is used by maintenance personnel for storage of cleaning gear and as a work area. This area should be centrally located to minimize walking distances. For economy of plumbing, it is recommended that janitor's closet(s) be near other areas with plumbing, and that they be provided on each floor of a multi-story facility.

a. **FINISHES**

Floor: concrete or vinyl tile

Walls: ceramic tile wainscot, wallboard, plaster, concrete block, exposed

Ceiling: exposed

b. **SPACE REQUIREMENTS.** The space required for the janitor's closet is 50 to 100 square feet.

4-21 ENVIRONMENTAL CRITERIA.

Environmental criteria for the above areas will be as shown in Table 4-3.

TABLE 4-3 ENVIRONMENTAL CRITERIA FOR AREAS

SPACE	ACOUSTICS					
	Ambient (db)	Estimated Peak (db)	Sound Quality			
Entrance and Lobby	30	85	AVG			
Multi-Purpose Room	30	80	AVG			
Public Toilets	45	80	ML			
User Card Catalog	30	75	MD			
Control Area	35	80	MD			
Reference Area	30	75	MD			
Current Periodical Area	35	75	D			
Microform Area	30	85	D			
Stack Area	35	70	MD			
Reading and Study Area	35	70	MD			
Conference Rooms	30	85	AVG			
Study Rooms	30	85	AVG			
Typing and Listening Booths	30	85	D			
Children's Area	35	85	MD			
Administrative Staff Offices	30	80	AVG			
Technical Services	40	80	AVG			
Shipping and Receiving	40	80	AVG			
Staff Lounge	35	75	MD			
Staff Toilets and Lockers	45	80	AVG			
Janitor's Closet	45	90	L			
SPACE	MECH/PLUMBING					
	Maximum Occupant Load	Thermostat	Air Chg/Hr	CW/I:W	Floor Drain	Exhaust
Entrance and Lobby		X	6			
Multi-Purpose Room		X	10	X	X	X
Public Toilets						
User Card Catalog			6-8			
Control Area			6-8			
Reference Area			6-8			
Current Periodical Area			6-8			
Microform Area			6-8			
Stack Area			6-8			
Reading and Study Area			6-8			
Conference Rooms			15			
Study Rooms			15			
Typing and Listening Booths			10			
Children's Area		X		X	X	X
Administrative Staff Offices		X	6-8			
Technical Services			6-8	X		
Shipping and Receiving			6-8			
Staff Lounge		X	6-8			
Staff Toilets and Lockers			10		X	X
Janitor's Closet			6	X	X	X

TABLE 4-3 ENVIRONMENTAL CRITERIA FOR AREAS (CONTINUED)

SPACE	ELECTRICAL					
	Intercom	Electrical Outlets	PA Speaker	Telephone	Clock	TV/Cable
Entrance and Lobby		110V	X	X		
Multi-Purpose Room		110V	X			X
Public Toilets		110V	X			
User Card Catalog	X	110V				
Control Area		110-220V	X	X		X
Reference Area	X	110-220V				
Current Periodical Area		110V	X			
Microform Area		110V	X			
Stack Area		110V				
Reading and Study Area		110-220V				
Conference Rooms		110V	X			X
Study Rooms		110V	X			X
Typing and Listening Booths		110V	X			
Children's Area	X	110V	X	X		X
Administrative Staff Offices		110V		X		
Technical Services		110-220V	X	X		
Shipping and Receiving		110V		X		
Staff Lounge		110-220V	X	X		
Staff Toilets and Lockers		110V	X			
Janitor's Closet		110V				
SPACE	LIGHTING					
	Daylight	Blackout Capability	Light Intensity (fc)	Dimming Capability	Task Light Supplement	
Entrance and Lobby	X		10		X	
Multi-Purpose Room			50	X		
Public Toilets			30			
User Card Catalog			60			
Control Area	X		60			
Reference Area			60			
Current Periodical Area			60-75			
Microform Area			60			
Stack Area			60			
Reading and Study Area	X		75		X	
Conference Rooms			75	X		
Study Rooms			75			
Typing and Listening Booths			75			
Children's Area	X		60			
Administrative Staff Offices	X		60			
Technical Services	X		60			
Shipping and Receiving			60			
Staff Lounge	X		60			
Staff Toilets			30			
Janitor's Closet			30			

CHAPTER 5

Space Organization Principles

5-1 GENERAL

This chapter describes space organization principles that may be employed in the development and review of designs. These are discussed in terms of functional layout principles, principles related to visual perception and control, modular layout principles, and principles related to site/climate constraints and opportunities.

5-2 PRINCIPLES RELATED TO SITE CONSTRAINTS AND OPPORTUNITIES

a. ORGANIZE SPACE IN RELATION TO THE SIZE, SHAPE AND ORIENTATION OF THE SITE. Based on the maximum coverage of the site desired, the building may be single-story or multi-story. Space organization must also consider the orientation of the site which will tend to determine the locations that will provide views and natural lighting or that will require protection against sun and glare.

b. ORGANIZE SPACES TO FIT INTO THE NATURAL TOPOGRAPHY. Existing ground forms, trees and other site features should be preserved insofar as is reasonably possible. At the same time, the space organization must function efficiently both indoor and outdoor. For example, a sloping site may suggest a split-level facility to preserve natural features, while access for the physically handicapped from parking areas into the building may require

grading to reduce slopes in certain areas. Spaces should be organized to take advantage of existing views.

c. ORGANIZE SPACES SO THAT THEY MAY BENEFIT FROM NATURAL WARMING AND COOLING EFFECTS. Where possible, building forms, courtyards, earth mounds, vegetation and trees should be provided to capture or direct air movement as well as to control the effects of the sun.

d. ORGANIZE SPACES IN RELATION TO VEHICULAR/PEDESTRIAN CIRCULATION. This must be accomplished with respect to access (to both site and building) by students, visitors and staff (including the handicapped), maintenance and service personnel.

(1) The main entrance should be visible from both the parking lot and the street.

(2) Service entrances should not be visible from the parking lot and the street, but should be identified with signs.

e. ORGANIZE SPACES TO ALLOW FUTURE EXPANSION OF FACILITIES. Existing or planned facilities which would limit orderly growth must be taken into consideration. If the building expands, site amenities such as parking will also require expansion.

5-3 PRINCIPLES RELATED TO BASIC SPATIAL ORGANIZATION

a. ORGANIZE SPACES INTO BASIC ORGANIZATIONAL SCHEMES. Space should be grouped to afford compatibility of activities, circulation and service requirements. The following three schemes are most applicable to library facilities:

(1) *Parallel Organization*. This scheme is characterized by parallel circulation spines along which groups of

spaces with similar functions are arranged. The academic and staff spaces are arranged along one spine, and the vocational-training spaces are grouped separately along another spine, as shown in Figure 5-1. The parallel scheme gives distance between academic and vocational-training activities which facilitates noise control, but may inhibit visual control. This type of scheme provides excellent opportunities for expansion, but may be difficult to adapt to unusual site conditions.

PARALLEL ORGANIZATIONAL SCHEME

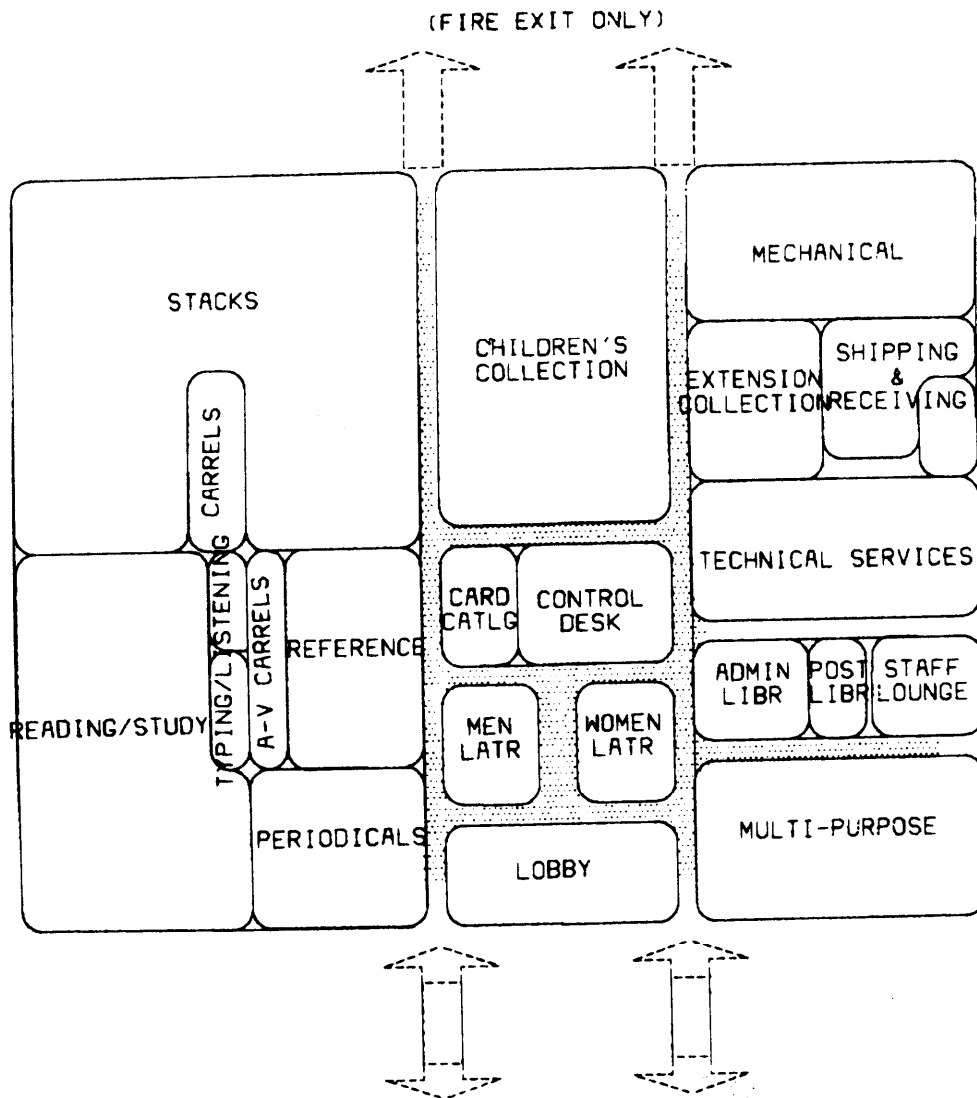

FIGURE 5-1

(2) *Axial Organization.* This scheme is developed by dividing the circulation into two axial paths separating the academic and vocational-training spaces along two different axes as shown in Figure 5-2. Spaces can be ar-

ranged along the axis on one or both sides. The axial scheme facilitates both noise and visual control. It also provides excellent opportunity for expansion of facilities and adapts well to varying site conditions.

AXIAL ORGANIZATIONAL SCHEME

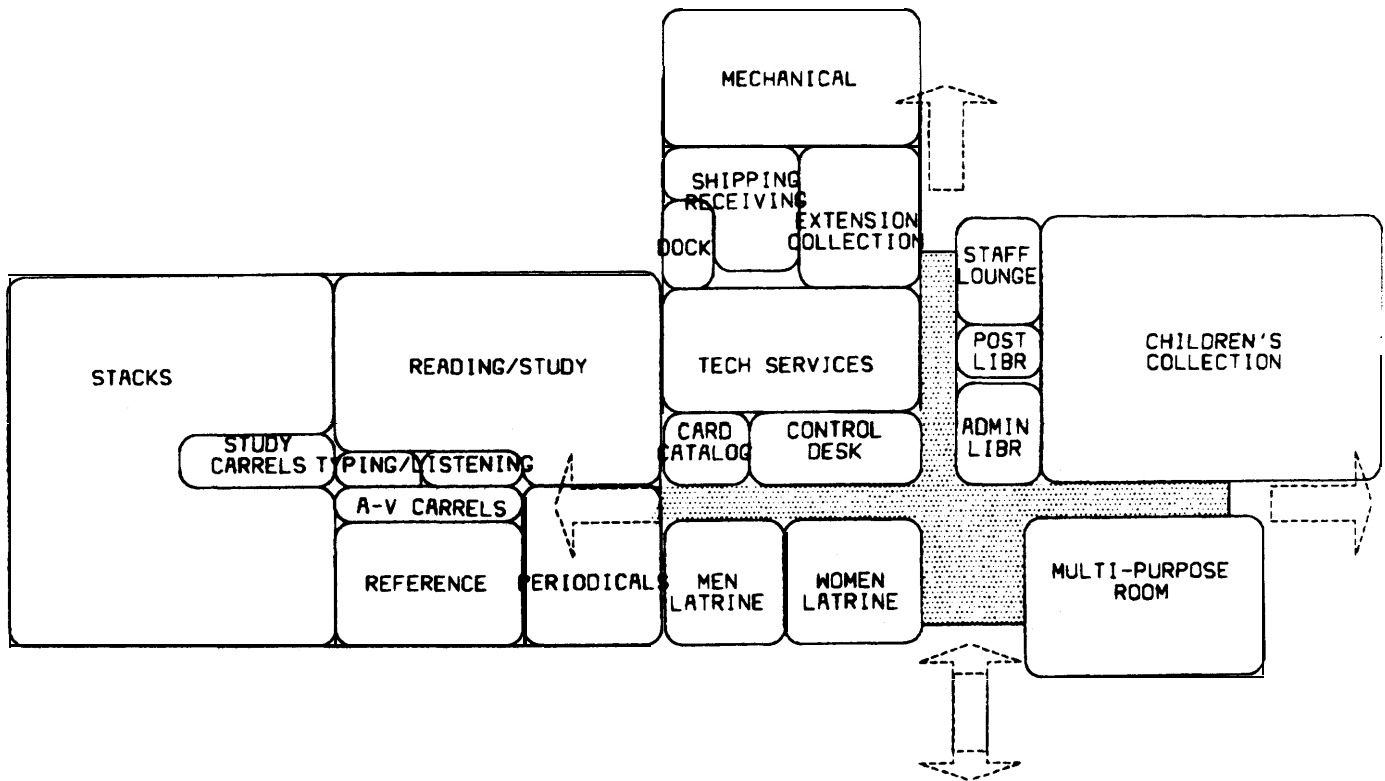

FIGURE 5-2

(3) *Enclosed View Organization.* This scheme is characterized by circulation linkages that both connect and separate activities. Academic and vocational-training spaces are arranged along individual spines, separated by a connector spine along which staff and support spaces

are arranged as shown in Figure 5.3. This enclosed view organizational scheme also facilitates good noise control but may inhibit visual control. This scheme is more suitable for severe climate conditions but may have limited adaptability to difficult site conditions.

ENCLOSED VIEW ORGANIZATIONAL SCHEME

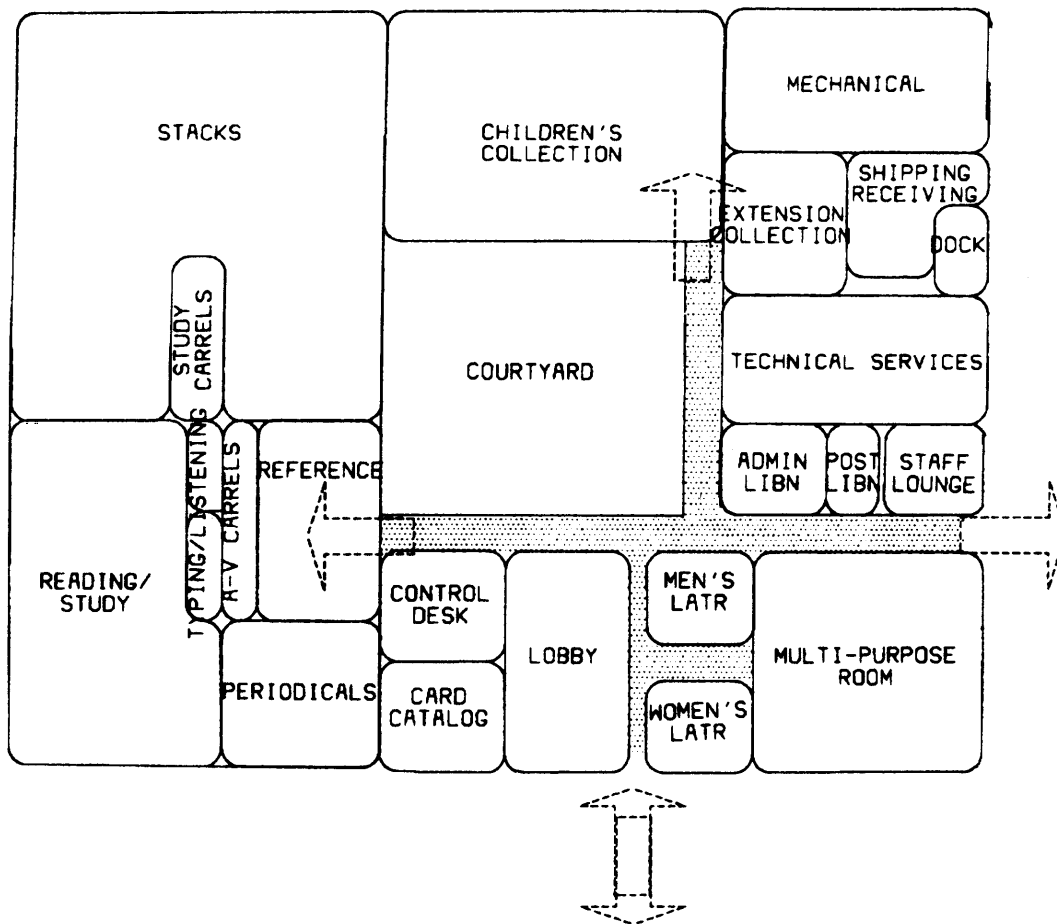

FIGURE 5-3

b. ORGANIZE SPACES IN CONJUNCTION WITH PLANNED SEQUENCES OF VIEWING POSITIONS. Each viewing position should be used to create a perceptual experience for participants as they move through the spatial organization scheme. Such experiences can be created by: arranging spaces to emphasize volumetric differences in heights, widths and lengths; through the use of

local points established by light, form and color (including natural elements inside and out); and through the use of decorative elements (color, texture, light and form) to establish visual rhythm and movement. Sequences of viewing positions should always be coordinated with circulation flows even though they may involve separate paths.

5-4 PRINCIPLES RELATED TO FUNCTIONAL LAYOUT

a. ORGANIZE SPACES TO ESTABLISH WORKABLE ADJACENCY RELATIONSHIPS. Students, visitors and staff must interact with one another, and some activities must be closely associated. Generally, the greater the interaction of persons and activities, or flow of materials between one space and another, the closer the spaces should be to each other. Refer to the Adjacency Chart, Table 5-1.

b. ORGANIZE SPACES TO ESTABLISH A CONVENIENT CIRCULATION FLOW. Visitors and students must be able to easily enter and exit the building and find the activities and staff provided. Staff must also be able to readily perform the tasks required, moving the material and equipment necessary to conduct instructional and other functions. Usually, spaces which generate heavy traffic should be located near to entrances, and those frequented by persons unfamiliar with the library should be near the main entrance.

c. ORGANIZE SPACES SO THAT ALL PERSONS CAN BE EFFECTIVELY EVACUATED DURING AN EMERGENCY. Space should be located, with respect to type

and load of occupancy, to minimize distance of travel to safe outside exits, or to protective construction zones.

d. ORGANIZE SPACES FOR FLEXIBILITY OF SPACE USE. Spaces should be organized so that they may be combined, separated or slightly modified to enhance the versatility of the building and to accommodate possible changes in library program functions. Space organization should allow for changes in degree of privacy, from being open for visual control to being closed for privacy.

e. ORGANIZE SPACES TO SIMPLIFY VISUAL CONTROL. Spaces requiring surveillance and control should be organized so that there is capability to supervise from a central viewing position or positions. Capability to supervise entrance and exit traffic, use of toilets and equipment as an example.

f. ORGANIZE SPACES IN RELATION TO SOUND LEVEL COMPATIBILITY. Cluster spaces which produce high noise levels so they can be more economically isolated or located remote from quiet spaces. Separate noisy from quiet spaces with circulation, storage and toilet spaces where possible.

TABLE 5-1 ADJACENCY CHART

	Adjacent	Near 25	Near 75	Isolated
1. Entrance & Lobby	2,3,5,13	8	20	10,17,21
2. Multi-Purpose Room	1,3	5	18,20	6
3. Public Toilets	1,2	5	20	
4. Public Card Catalog	6.5	8,14,16,9, 10,11	9,10,11, 20	17,21
5. Control Area	1,4,14,16	2,3,6,7,8, 12	9,10,11, 20	17
6. Reference Area	4,7,10,11, 14	5,9	20	2,17,21
7. Periodicals Area	6	5,11,9	20,10	17,21
8. Children's Area		1,4,5	20	10,11,17,21
9. Stack Area	10,11	4,5,6,16	20	1,17,21
10. Reading Area	6,9,11	4,5	7,20	8,17,21
11. Study Area	6,9,10	4,5,7	20	8,17,21
12. Typing & Listening Booths		4,5		
13. Admin. Librarian	1,16	14,15,18	20	
14. Post Librarian	5.6	4,16,18	20	
15. Extension Collection	16,17,21	13	20	
16. Technical Services	5,15,17,21	4,9,13,14, 18	20	
17. Shipping & Receiving	15,16,21		20	1,5,6,7,8,9, 10,11,18
18. Staff Lounge		13,14,16	20	17,21
19. Stack Washrooms & Lockers	16,18		13,14,15, 17,20,21	
20. Janitor's Closet			All	
21. Bookmobile Garage	15,16,17		20	1,6,7,8,9, 10,11,18

5-5 PRINCIPLES RELATED TO STRUCTURE AND ENVIRONMENTAL SUPPORT.

a. ORGANIZE SPACES TO MAXIMIZE ECONOMY OF STRUCTURE. Establish a standard module (where applicable) which is efficient and economical for both the layout of structure and the layout of ceiling and wall systems, lighting and air handling equipment. The structure must handle critical floor loads and allow for possible multi-use. Overall, the building should be made as compact as possible, to minimize both structure and HVAC support in terms of heat loss and/or gain.

b. ORGANIZE SPACE TO MINIMIZE REQUIREMENTS FOR RESISTIVE CONSTRUCTION AND/OR EXTINGUISHMENT SYSTEMS. Group spaces requiring this type of protection.

c. ORGANIZE SPACES TO PROVIDE PROTECTIVE CONSTRUCTION ZONES. Where fallout or storm protection is required, spaces which employ resistive construc-

tion for other purposes (e.g., fire protection) and those that may have built-in characteristics for providing such protections should be organized where possible into dual-use protective zones.

d. ORGANIZE SPACE TO MAXIMIZE ECONOMY OF ENVIRONMENTAL SUPPORT SYSTEMS. Spaces should be organized into comfort zones where different lighting and/or HVAC may be required to support the activity in the space or group of spaces. (See Chapter 4, Table 4-1 for a summary of environmental criteria.) Spaces requiring plumbing services should be organized to minimize pipe runs, for both supply and waste. Space for mechanical/electrical equipment requiring the attention of facilities engineer personnel and communications officer such as for operation, maintenance and repair purposes, should be located to provide both efficient service to respective groups of spaces, and access from the outside.

CHAPTER 6

Main Libraries

6-1 GENERAL

a. REFERENCES

(1) AR 28-1 Army Recreation Services in the primary directive for main post libraries is contained in this document.

(2) The DOD 4270.1-M Construction Criteria Manuals provides maximum space allowances based on the authorized projected military strength of using installations.

b. OBJECTIVES OF MAIN LIBRARIES PROGRAM. The primary objectives of the main library program are to promote use of information media for recreation, information, and education; and to support education and training programs. The main library has functions which are similar to both public and academic libraries. As a public library, it provides encouragement and assistance to patrons, especially newcomers, to develop and explore their interests. Users who come for specific material should find it easily. Users who enter without a specific purpose should find items of current interest on display, and librarians to provide the help they need. As an academic library, it provides convenient access to reference and reserve materials for educational and mission-related requirements. It provides all users with quiet, comfortable reading and study accom-

modations. The main library is the hub of the entire post library system, and normally houses administrative offices and technical services, which support the main collection, branch libraries, field libraries, and bookmobiles.

6-2 PLANNING AND DESIGN CONSIDERATIONS

a. LIBRARY USERS. Users include the entire military community, including active and retired military personnel and their dependents. Civilian employees of the post may have borrowing privileges for work-related usage.

b. THE COLLECTION

(1) *The Basic Collection.* The total book stock for each Army installation library system can be provided by the librarian in charge, and should be requested during the initial stage of planning. According to AR 28-1, such a post system collection should comprise at least three volumes per capita based on military strength. Post collections may considerably exceed this basic criterion, however. Table 6-1 illustrates typical compositions of the basic collection (bound volumes of adult fiction, nonfiction and reference) for central main post libraries at installations of various strengths. The sizes of facilities shown correspond to the maximum areas allowed by DOD for each installation strength.

TABLE 6-1 COMPOSITION OF THE BASIC COLLECTION

Size of Facility (GSF)	6,250	10,500	18,000	20,800	24,000	30,000
Fiction	3,700- 5,600	6,600- 11,400	14,400- 19,200	18,000- 21,000	21,000- 23,000	24,000- 26,000
Non-Fiction	4,950- 7,500	8,460- 14,950	18,720- 25,200	23,400- 27,300	27,300- 30,700	31,200- 33,900
Reference	600- 900	1,440 2,160	2,880- 3,600	3,600- 4,200	4,200- 4,800	4,800- 5,100
Total Books (Working Capacity)	9,250- 14,000	10,500- 18,500	36,000- 48,000	45,000- 52,500	52,500- 58,500	60,000- 65,000
Minimum Annual Additions	1,100	1,850	3,100	3,600	4,600	6,500

(2) *Children's Collection.* The size of the children's collection depends on the number of children on the post. Children's requirements may increase total volumes by as much as 1/3 over the basic collection. For example, in a library system of 60,000 adult volumes at a post with a high dependent population, the children's collection may contain 20,000 volumes. Other posts may require no children's collection. The children's collection may be located entirely in the main library, or in a branch library, near the family housing area, or distributed throughout the system. Paragraph 6-3.a(1) shows recommended sizes of collections for various sizes of facilities and post populations.

(3) *Auxiliary Materials.* According to AR 28-1, "Libraries will maintain a varied, authoritative collection of current and retrospective reading and audio-visual materials encompassing various reading levels, interests and cultural background of personnel served; mission related technical publications; and materials required for education support and career advancement". Therefore the basic collection will be supplemented by a variety of auxiliary materials, including, but not limited to: periodicals, paperbacks, records, tapes, microforms, maps, and prints.

(a) *Periodicals.* The periodical collection will typically include three to four hundred separate current periodicals titles, depending on the specific subject interests and missions to be supported; and at least ten newspaper titles, including national, local, specialized, and military publications.

(b) *Paperbacks.* Paperbound books will generally be shelved with the regular collection, or displayed in separate racks such as those found in bookstores.

(c) *Records.* LP sound recordings may be shelved in oversize (13 inch minimum depth) shelves or in bins like those found in record stores. If the library has a central sound system, records may be stored behind the control desk convenient to the playback console.

(d) *Tapes.* Cartridges and cassettes will be stored in cabinets. Tape storage is preferably located near or behind the control desk.

(e) *Microforms.* Microfilms of newspaper runs or microprint of U.S. Government documents are housed in the periodicals area in cabinets with long shallow drawers permitting the housing of spool films in individual cardboard boxes.

(f) *Maps.* Maps will be located in the reference area. Sheet maps are usually stored in plan files; folded maps may be kept in vertical files.

(g) *Art Prints.* Frames or unframed circulating prints will be stored and displayed near the control area.

(4) *Extension Collection.* The Extension Department extends library services and materials beyond the main library by means of branch libraries, mobile units, field library units, and paperback book outlets. The exten-

sion collection in the main library is devoted primarily to the bookmobiles. Each bookmobile typically carries 3,000 volumes, has 1,000 volumes in circulation, and has an uncirculated back-up collection of 6,000 volumes, for a total of 10,000 volumes. The extension librarian is also the supervisor of branch libraries, so books belonging to the branches may be stored in the extension area.

c. **COMMUNITY PROGRAM.** Ideally, the main library serves as a focus of recreational and cultural activity on the post. Space should be provided to accommodate meetings of clubs, committees, discussion groups, and small conferences. Provisions should be made for the showing of films and slides in this space.

d. **STAFF.** The staff requirement depends upon the library size, which is based upon the post population; however, the staffing of large library facilities will vary, since the total population served may vary considerably. The staffing figures shown in Table 6-2 are typical examples. Staffing requirements for individual projects should be developed by the administrative librarian and furnished to the design agency.

TABLE 6-2 STAFFING

GSF (Max)	Professionals		Non-Professionals		Total
	Librarian	Library Tech- nician	Clerk Typist	Ware- house- Man	
6,250	1	1	—	—	2
10,500	2	3	—	—	5
18,000	2	4	1	—	7
20,800	3	4	1	—	8
24,000	4	5	2	—	11
30,000	6	6	3	1	16
(serving up to 40,000)					
30,000	8	8	4	1	21
(serving up to 50,000)					

e. **SITE SELECTION.** The following are desirable characteristics for a main library site.

(1) Central to post and close to shopping, recreational, and educational facilities for convenience of users.

(2) Readily accessible from the main post entrance for use by off-post personnel.

(3) Closer to enlisted than to officer's quarters since many enlisted personnel do not have the use of automobiles.

(4) Adjacent to other primarily night-use facilities, or in conjunction with the Community Center

(5) Near the General Education Development Center to promote joint use of facilities.

f. PLANNING THE BUILDING

(1) *Programming Requirements.*

(a) *General.* Chapter 3 of DOD 4270.1-M sets forth space allowance criteria which should be utilized in determining the size of the library. Table 6-3 gives the maximum space allowed as a guide for preparation of DD Form 1391. Column 1 indicates the aggregate military strength of the post from which space allowances are established. Column 2 shows the maximum GSF allowed for each military strength. These allowances may be increased by 10 percent where the facility is designated as a command reference center. If bookmobiles are operated, a minimum of 300 square feet per bookmobile may be added for storing the bookmobile collection, book trucks, and workspace for the bookmobile staff. These space allowances include provisions for an installation technical services department for centralized processing of library materials. The actual space requirements (see Para 2-3a) should be estimated using this guide, and the appropriate figures should be entered under Gross Area (Item 18.f), Primary Facility (Item 20.a) and total Requirement (Item 23a) of DD Form 1391. Column 3 is an approximation of the mechanical space required to heat and air condition each size of building in a moderate climate. A more accurate estimate of the mechanical area should be performed by a mechanical engineer and entered separately under Primary Facility (Item 20.b) as "Mech Room". Column 4 shows the total size of the project resulting from adding columns 2 and 3. A corresponding figure obtained from the addition of the actual requirements should be entered under Primary Facility on the top line of Item 20 of DD Form 1391. "Standard Design" (Item 17a) should be checked and "DG 1110-3-110" should be entered under Drawing Number (Item 17.c). See AR 415-15 for complete instructions on completing DD Form 1391.

(b) *Total Building Space Requirements.* The sum of the NASF requirements multiplied by 1.15 to allow for core area is the required gross area (GSF). GSF must not exceed the figure given in column 2 of Table 6-3, modified to include appropriate space increases as indicated in Paragraph 6-2.f(1)(a), example for a 22,000 military strength post, with a requirement for a bookmobile.

Total Actual NASF requirement	25,652 NASF
Core Area (15%)	<u>3,848 SF</u>
Total Actual Space Requirement	29,500 GSF
Table 6-3 allowance for 22,000 military strength	30,000 GSF
Allowance for Bookmobile collection	<u>810 GSF</u>
Total Authorized Allowance	30,810 GSF

TABLE 6-3 MAXIMUM SPACE ALLOWANCE FOR MAIN LIBRARIES

Military Strength	Gross Area	Approx Mech Space	Total Program Requirement
up to 500	2,500	250	2,750
501 to 1,500	4,500	400	4,900
1,501 to 2,500	6,250	500	6,750
2,501 to 4,000	8,000	560	8,560
4,001 to 6,000	10,000	600	11,150
6,001 to 8,000	12,000	650	12,600
8,001 to 12,000	18,000	700	18,700
12,001 to 16,000	20,800	830	21,630
16,001 to 20,000	24,000	960	24,960
20,001 to 26,000	30,000	1,200	31,200
26,001 to 32,000	36,000	1,300	37,300
32,001 to 40,000	44,000	1,400	45,400
40,001 to 50,000	54,000	1,700	55,700
50,001 to 60,000	64,000	2,000	66,000

The actual space requirement is less than the authorized allowance; therefore, use 29,500 GSF and enter this figure under "Quantity" on DD Form 1391. Enter the estimated size of mechanical room on Item 20.a.

(c) *Actual Space Requirements.* It is the responsibility of the using service to determine how much space will be required for an individual facility. Table 6-3 depicts maximum space allowances, not actual space requirements. The actual space requirements depend on the size and composition of the actual collection, and the number and type of necessary seating accommodations. Both of these factors are affected by the projected size and mission of the post and by the availability of library materials from other nearby sources. The librarian must consider a number of factors that affect the library planning. Existing and future use patterns should be carefully analyzed since the age and use habits of patrons will be a strong determinant of the library plan. The main library is used by both Army personnel and by dependents. On an average installation the total population served is approximately twice the military strength. If the primary post mission is small, the number of dependents will be small; and the children's area should be correspondingly small. Posts with many branch libraries may require additional space in the extension and technical services areas. These and other factors must be thoroughly researched in the initial planning stage.

(2) *Grouping of Related Spaces.* The space requirements developed in conjunction with Paragraph f-1.b. have various uses and adjacency relationships related to the need to combine separate activities, each circulation and develop an efficient daily operation. In the main library, it is desirable to consider spaces under three main headings as follows:

GENERAL USE SPACES

Entrance and Lobby
Multi-Purpose Room
Public Toilets

PUBLIC SERVICES SPACES

Public Card Catalog
Control Area
Reference Area
Periodicals Area
Children's Area
Stack Area
Reading and Study Areas
Typing and Listening Booths

STAFF SPACES

Administrative Librarian
Post (Supervisory) Librarian
Extension Collection
Technical Services
Shipping and Receiving
Staff Lounge
Staff Washrooms and Lockers
Janitor's Closet
Bookmobile Garage

(3) *Joint Use Facility.* It may be advantageous to combine the main library with the General Education Development Center. The meeting rooms, public toilets, lobby, and entrance could be shared for more efficient space utilization.

(4) *Intercom.* As intercom should be provided between the following librarians' work stations: administrative, post, technical services, extension services, reference, and the control desk.

(5) *Music and Paging System.* Music should be playable from the control desks with individual room control of remote speakers. The speaker system should also be usable for announcements and paging.

(6) *TV Jacks.* TV jacks should be provided for reception of local channels or closed circuit broadcasts.

(7) *Central Vacuum.* Central vacuum cleaning facilities should be provided in areas indicated in Table 6-25.

g. **PARKING.** A maximum of one parking space per 500 square feet of library, which equals 60 spaces for a 30,000 square feet library, should be provided. The parking spaces should be distributed to accommodate staff, user and service vehicles. Parking for bicycles and motorcycles should be provided. One parking space for the handicapped is required for the first 20 parking spaces and one for each 50 spaces thereafter. A minimum of two spaces shall be provided. These spaces must have barrier-free access into the building without requiring persons to travel behind parked cars or across driveways. Limit of travel is 100 feet to main entrance.

6-3 INDIVIDUAL SPACE CRITERIA

Individual space criteria which is general to all library types is provided in Chapter 4. The criteria given below is intended to supplement the information in Chapter 4, with criteria specific to main libraries.

a. **ENTRANCE AND LOBBY.** These areas are used primarily for library functions, but also for activities held in the multi-purpose room, when the rest of the library may be closed. Therefore, the multi-purpose room and public toilets should be adjacent to the entrance and lobby. Provide an electric eye counter between lobby and control area. The lobby should permit the selective closing of public service and staff areas to permit the use of the multi-purpose room and toilets after hours.

(1) *Space Requirements.* See Table 6-4.

(2) *Space Utilization Plan.* See Figure 6-1.

TABLE 6-4 ENTRANCE AND LOBBY SPACE REQUIREMENTS

Items	Unit Area Allowance	6250		10500		18000		20800		24000		30000	
		QTY	GSF	QTY	GSF	QTY	GSF	QTY	GSF	QTY	GSF	QTY	GSF
Lounge Chairs	30	2	60	2	60	4	120	6	180	8	240	10	300
Vestibule	100	1	100	1	100	1	100	1	100	1	100	1	100
Display Cabinets	25	—	—	—	—	1	25	1	25	1	25	2	50
Public Telephone	25	—	—	—	—	1	25	1	25	1	25	1	25
Drinking Fountain*	25	—	—	—	—	1	25	1	25	1	25	1	25
Total			160		160		295		355		415		500

*Accessible to Physically Handicapped

ENTRANCE AND LOBBY SPACE UTILIZATION PLAN

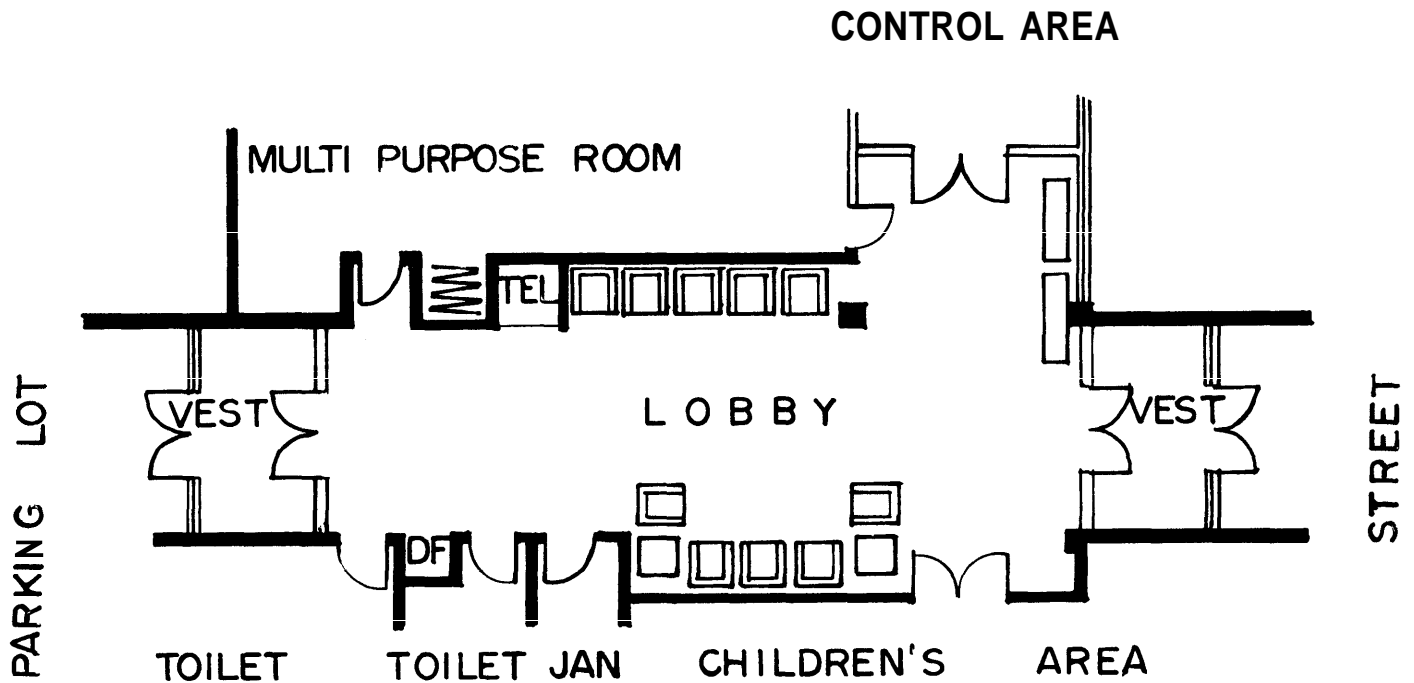

FIGURE 6-1

b. MULTI-PURPOSE ROOM

(1) *Adjacencies.* The multi-purpose room should open onto the lobby. Access should be provided from the reading areas to expand the seating capacity of the library when the multi-purpose room is not being used for group activities. The staff kitchen should be nearby to facilitate food service. Ideally, storage for chairs and audiovisual equipment should be shared with the children's area.

(2) *Special Considerations.* A movable partition with lock should divide space into unequal parts; each divided area should have separate access. Provide locks on each door, keyed from both sides. Provide coat closet.

(3) *Environmental Criteria.* Air conditioning and heating shall be zoned to allow independent use of the space.

(4) *Space Requirements.* See Table 6-5.

TABLE 6-5 MULTI-PURPOSE ROOM SPACE REQUIREMENTS

Items	Unit Area Allowance	6250 GSF		10500 GSF		18000 GSF		20800 GSF		24000 GSF		30000 GSF	
		QTY	NASF	QTY	NASF	QTY	NASF	QTY	NASF	QTY	NASF	QTY	NASF
Lounge Seating	30/seat	—	—	—	—	10	300	10	300	10	300	10	300
Table and Chairs	20/seat	—	—	—	—	10	250	10	250	10	250	10	250
Portable Seating	20/seat	—	—	—	—	20	400	20	400	20	400	20	400
AV and Chair Storage		—	—	—	—	—	50	—	50	—	50	—	50
Total							1000		1000		1000		1000

Space requirements shown are minimum. Provide additional space with dividers as necessary to meet installation requirements. Note: See unit allowances.

(5) Space Utilization Plan. See Figure 6-2.

MULTI-PURPOSE ROOM SPACE UTILIZATION PLAN

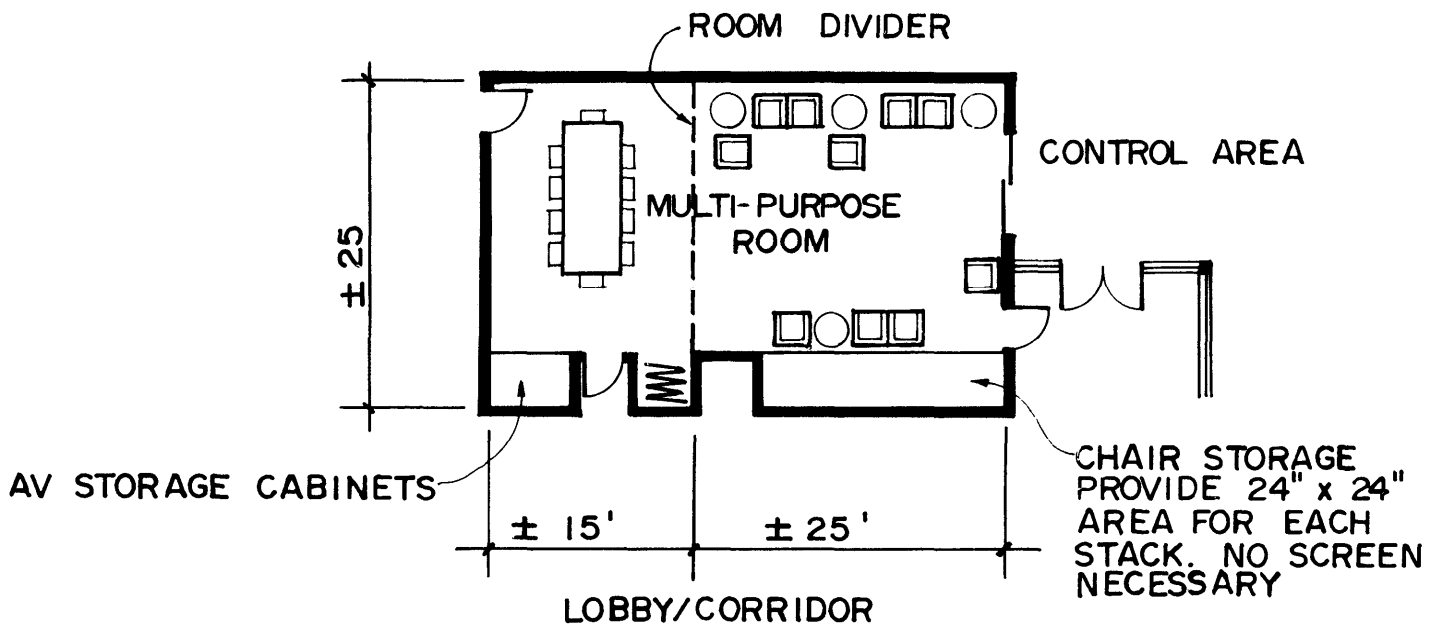

FIGURE 6-2

c. PUBLIC TOILETS. Public Toilets are required during regular library hours and after hours when the multi-purpose room is open. Separate facilities for men and women should be adjacent to the lobby and convenient to the multi-purpose room. The entrance to the public toilets should be visible to the control desk if practicable.

(1) Space Requirements. See Table 6-6 If the anticipated user population is significantly different from 50 percent male and 50 percent female, or if the number of user seats for each library size differs from the number of seats suggested in this guide, the fixture allocation should be adjusted in accordance with Table 10-7 of DOD 4270.1-M.

TABLE 6-6 PUBLIC TOILETS SPACE REQUIREMENTS

Items	Typical Occupancy	30 Men 30 Women		51 Men 51 Women		90 Men 90 Women		103 Men 103 Women		121 Men 121 Women		150 Men 150 Women	
		Unit Area	GSF	GSF	GSF	GSF	GSF	GSF	GSF	GSF	GSF	GSF	
	Allowance	QTY	NASF	QTY	NASF	QTY	NASF	QTY	NASF	QTY	NASF	QTY	NASF
Men													
WC	25	2	50	3	75	5	125	5	125	5	125	6	150
Urinals	25	1	25	2	50	3	75	3	75	3	75	3	75
Lavatories	15	2	30	3	45	5	75	5	75	5	75	6	90
Women													
WC	25	2	50	4	100	6	150	6	150	6	150	6	150
Lavatories	15	2	50	4	60	6	90	6	90	6	90	6	90
Total			205		330		515		515		515		555

(2) Space Utilization Plan. See Figure 6-3.

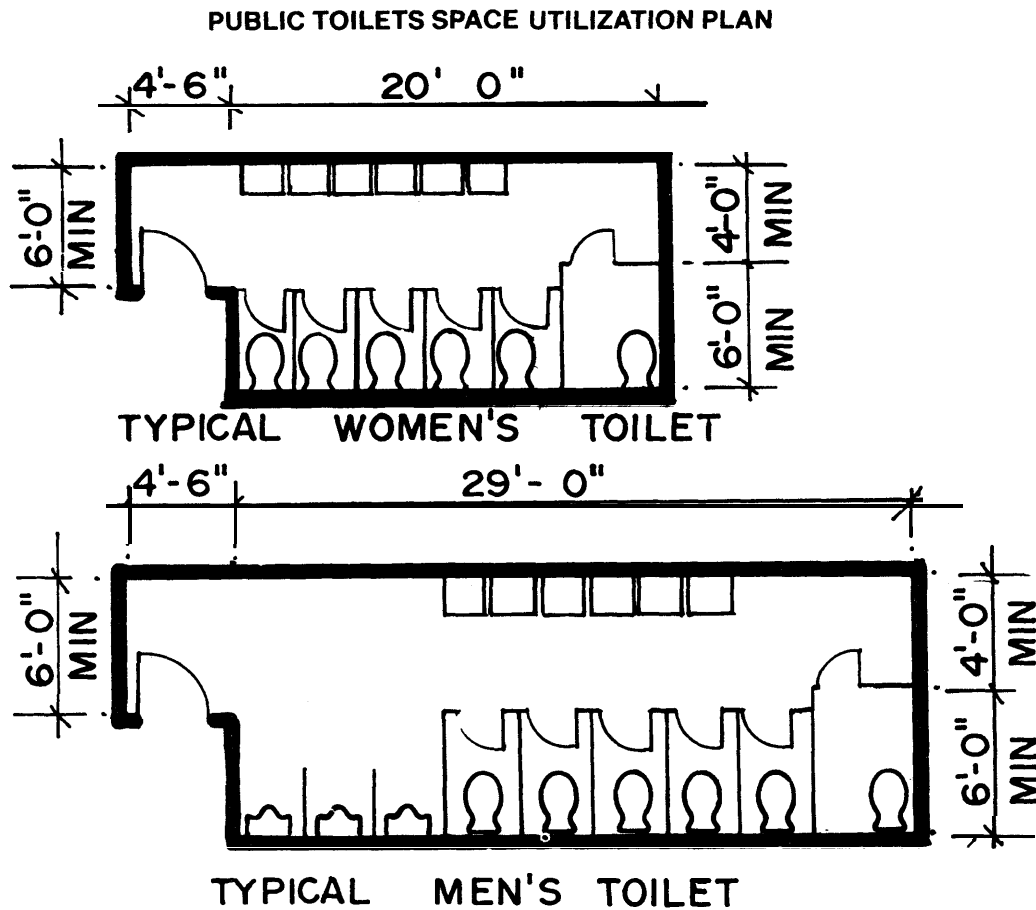

FIGURE 6-3

d. PUBLIC CARD CATALOG

(1) *Space Requirements.* See Table 6-7.

TABLE 6-7 PUBLIC CARD CATALOG SPACE REQUIREMENTS

Items	Unit Area Allowance	6250 GSF		10500 GSF		18000 GSF		20800 GSF		24000 GSF		30000 GSF	
		QTY	NASF	QTY	NASF	QTY	NASF	QTY	NASF	QTY	NASF	QTY	NASF
15-tray units	17	13	51	6	102	12	204	15	255	18	306	20	340

(2) *Space Utilization Plan.* See Figure 6-4.

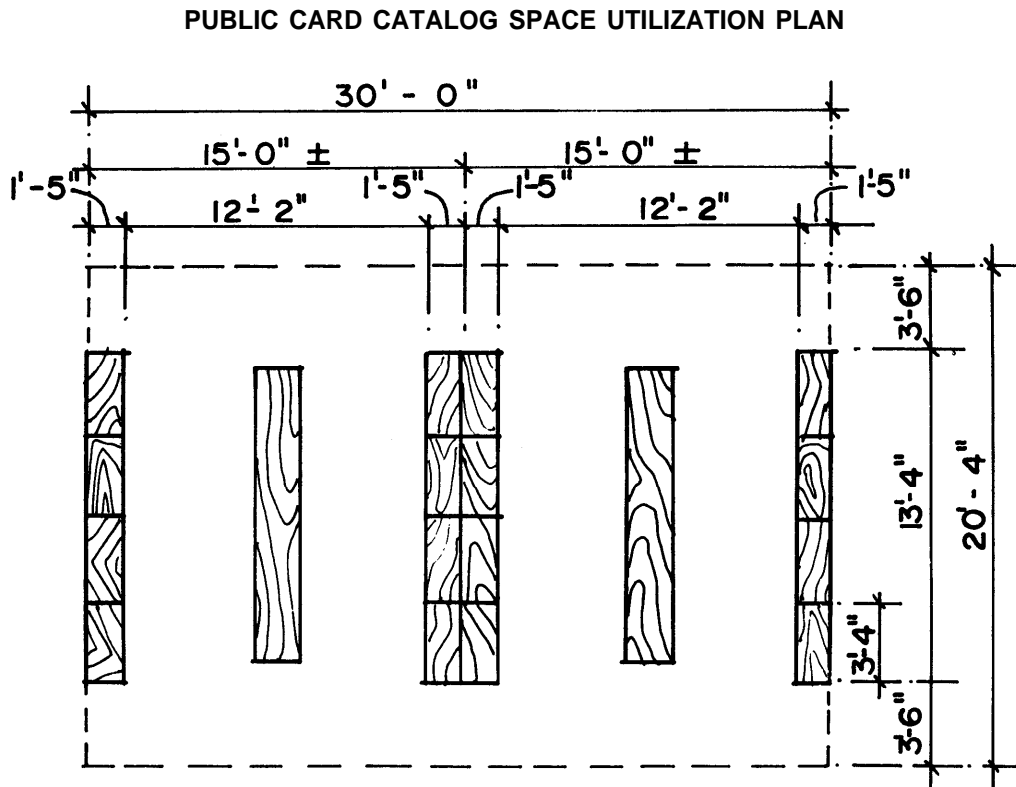

FIGURE 6-4

e. CONTROL AREA. A work area behind the desk is used for maintenance of files used at the control desk, processing of overdue notices and making minor repairs to materials. The work area must include storage space for

reserve materials and for equipment that is to be checked out. The work area should be adjacent to technical services. Color should contrast with carpet in the general reading areas. Provide a console for PA and music.

(1) *Space Requirements Table.* See Table 6-8.

TABLE 6-8 CONTROL AREA SPACE REQUIREMENTS

Items	Unit Area Allowance	6250 GSF		10500 GSF		18000 GSF		20800 GSF		24000 GSF		30000 GSF	
		QTY	NASF	QTY	NASF	QTY	NASF	QTY	NASF	QTY	NASF	QTY	NASF
Control Desk	240	1	240	1	240	1	240	1	240	1	240	1	240
Work Area	100	1	100	1	100	1	100	1	100	1	100	1	100
Shelving	9	6	54	6	54	6	54	6	54	6	54	6	54
Copy Machine	100	1	100	1	100	1	100	1	100	1	100	1	100
Recordings	9	6	54	6	54	6	54	6	54	6	54	6	54
Total			548		548		548		548		548		548

(2) *Space Utilization Plan.* See Figure 6-5.

CONTROL AREA SPACE UTILIZATION PLAN

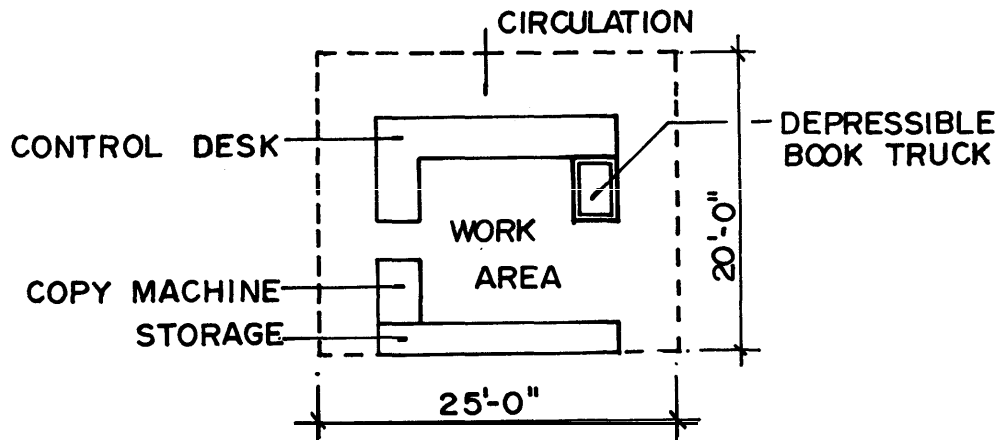

FIGURE 6-5

f. REFERENCE AREA. The larger main libraries have a reference librarian who answers research and reference questions and assists patrons in finding and using library materials. The card catalog area should be adjacent and

visible from the reference librarian's desk. Periodicals, microform, and the non-fiction section of the book stacks should be nearby.

(1) *Space Requirements Table.* See Table 6-9.

TABLE 6-9 REFERENCE AREA SPACE REQUIREMENTS

Items	Unit Area Allowance	6250 GSF		10500 GSF		18000 GSF		20800 GSF		24000 GSF		30000 GSF	
		QTY	NASF	QTY	NASF	QTY	NASF	QTY	NASF	QTY	NASF	QTY	NASF
Shelving	10	12	120	29	290	48	480	56	560	64	640	68	680
Ref Librarian Desk	150	—	—	—	—	—	—	1	150	1	150	1	150
Armchair													
Side Chair													
Book Truck													
2 Sect. Shelving													
Map Case	40	1	40	1	40	1	40	1	40	1	40	1	40
Atlas Case	25	1	25	1	25	1	25	1	25	1	25	1	25
Diet Stand	25	1	25	1	25	1	25	1	25	1	25	1	25
Globe Stand	25	1	25	1	25	1	25	1	25	1	25	1	25
Tables	25	6	150	12	300	26	650	26	650	30	750	45	1125
Lounge	30	—	—	3	75	3	75	4	120	4	120	5	120
Index Table	25	—	—	4	100	4	100	4	100	6	150	8	200
Totals			385		880		1420		1695		1925		2420

(2) Space Utilization Plan. See Figure 6-6.

REFERENCE AREA SPACE UTILIZATION PLAN

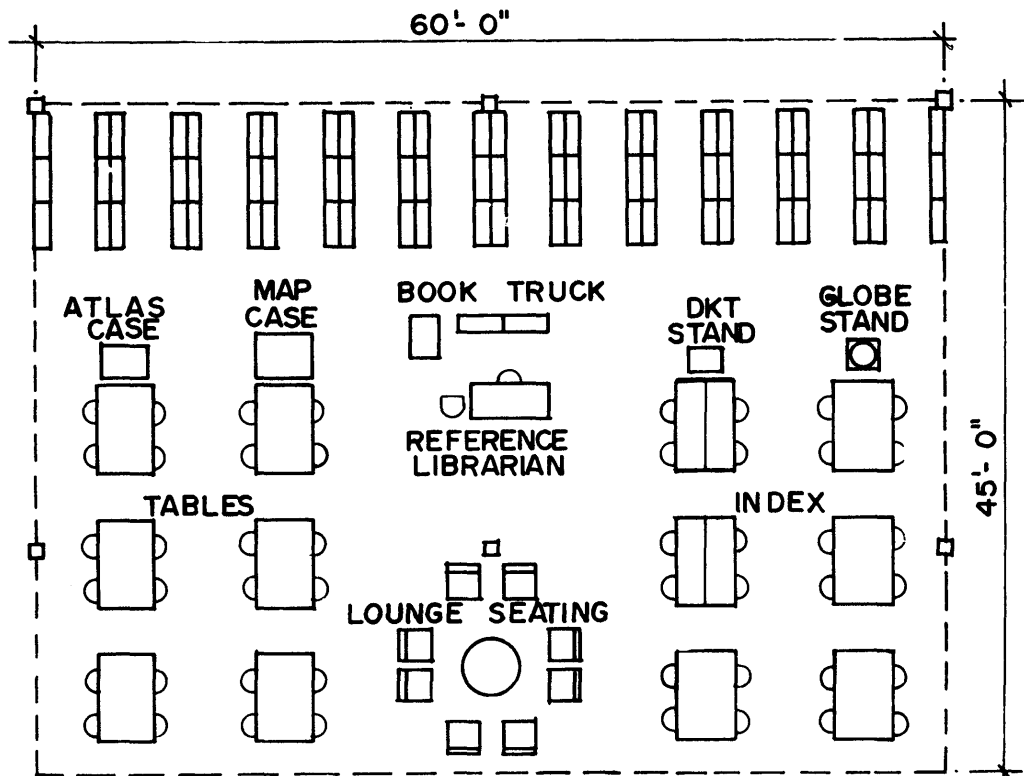

FIGURE 6-6

g. PERIODICALS AREA. The periodicals area should be visible from the control area. Microform should be near the reference area and easily accessible to the reference li-

brarian. Provide shelving for current periodicals up to about one year old. Older issues are boxed and shelved in the stacks area.

(1) *Space Requirements.* See Table 6-10.

TABLE 6-10 PERIODICALS AREA SPACE REQUIREMENTS

Items	Unit Area Allowance	6250 GSF		10500 GSF		18000 GSF		20800 GSF		24000 GSF		30000 GSF	
		QTY	NASF	QTY	NASF	QTY	NASF	QTY	NASF	QTY	NASF	QTY	NASF
Lounge Seating	30	9	270	15	450	22	660	24	720	27	810	35	1050
Table Seating	25	2	50	2	50	4	100	4	100	4	100	6	150
AV Carrel	40	—	—	—	—	1	40	2	80	3	120	4	160
Microfilm Stor	11	4	44	5	55	7	77	8	88	8	88	8	88
Microfiche Stor	11	1	11	1	11	1	11	1	11	1	11	1	11
Newspaper Rack	13	3	39	3	39	3	39	3	39	3	39	3	39
Shelving	15	7	105	7	105	14	210	14	210	14	210	20	300
Total			519		710		1137		1248		1378		1798

(2) *Space Utilization Plan.* See Figure 6-7.

PERIODICALS AREA SPACE UTILIZATION PLAN

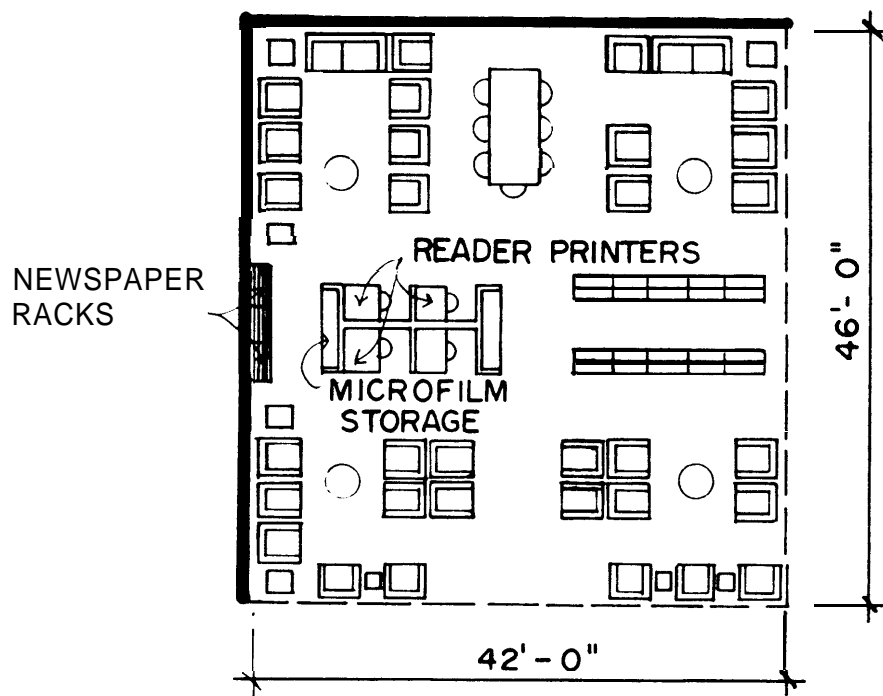

FIGURE 6-7

h. CHILDREN'S AREA. Table 6-11 shows the children's area requirements for typical posts where the total population is twice the military population, based on recommended sizes of collections for those populations.

(1) *Space Requirements*. See Table 6-11.

TABLE 6-11 CHILDREN'S AREA SPACE REQUIREMENTS

Items	Total Post Population	3001- 5000		8001- 12000		16001 - 24000		24000- 32000		32001 - 40000		40001- 52000	
	Collection Size	2500 3000		7500		12000		15000		17500		20000	
	Unit Area Allowance	6250 QTY	GSF NASF	10500 QTY	GSF NASF	18000 QTY	GSF NASF	20800 QTY	GSF NASF	24000 QTY	GSF NASF	30000 QTY	GSF NASF
Shelving	11	12	132	88	968	141	1551	176	1936	206	2266	235	2585
Card Catalog	17	1	17	3	51	4	68	5	85	6	102	7	119
Children's Lib	125									1	125	1	125
Desk													
Chair													
Side Chair													
1 Sect Shelv													
12-Dwr File													
1 Book Truck													
Cushions	15							10	150	15	225	20	300
Seating	20	8	160	12	240	16	320	20	400	24	480	32	640
Children's Toilets													
Boys	50		*		*		*		*	1	50	1	50
Girls	50		*		*		*		*	1	50	1	50
Storage (2°/0)			5		30		40		50		70		80
Total			314		1289		1979		2621		3368		3949

*Include children's fixtures in public toilet

(2) *Space Utilization Plan*. See Figure 6-8.

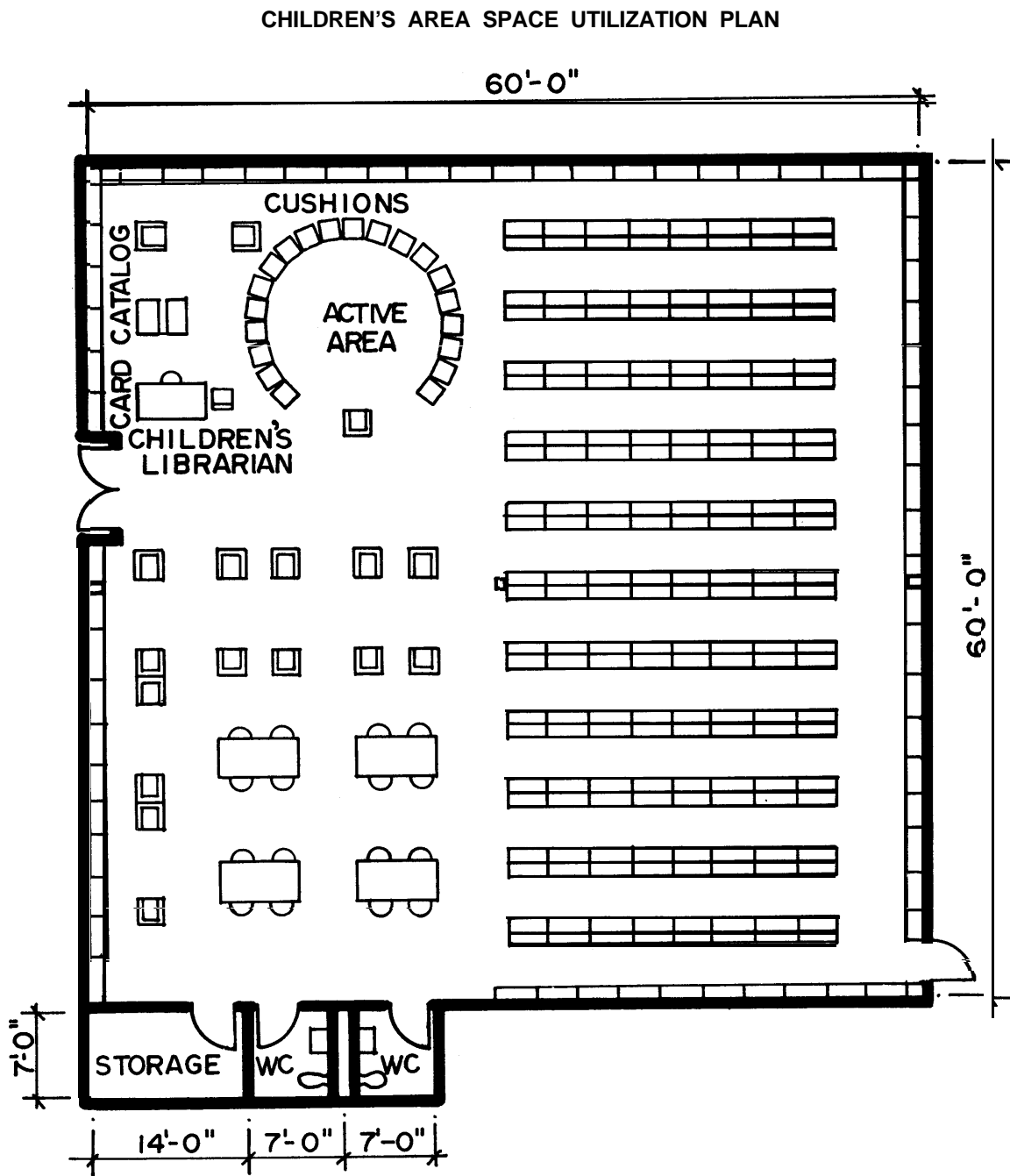

FIGURE 6-8

i. STACK AREA. The public card catalog and reference area should be adjacent. Technical Services should be nearby. Stack areas should be close to and interspersed with table or carrel, and possible lounge seating. The fiction stacks should generally be near lounge furniture and the non-fiction stacks near tables and carrels. Approxi-

mately 10 percent of the shelving should be 18 inches deep to accommodate oversize volumes. Stacks should be oriented so that control desk personnel can see down the aisles. If this is not possible, they should be oriented so that the reference librarian can see down the aisles.

(1) *Space Requirements.* See Table 6-12.

TABLE 6-12 STACK AREA SPACE REQUIREMENTS

Items	Unit Area Allowance	6250 GSF		10500 GSF		16000 GSF		20600 GSF		24000 GSF		30000 GSF	
		QTY	NASF	QTY	NASF	QTY	NASF	QTY	NASF	QTY	NASF	QTY	NASF
Shelving 8-12 in. deep	9	140	1260	211	1899	362	3258	409	3681	459	4131	644	5796
Shelving 18 in. deep	11	12	132	17	187	30	330	32	352	35	385	40	440
Total			1392		2086		3588		4033		4516		6236

(2) *Space Utilization Plan.* See Figure 6-9.

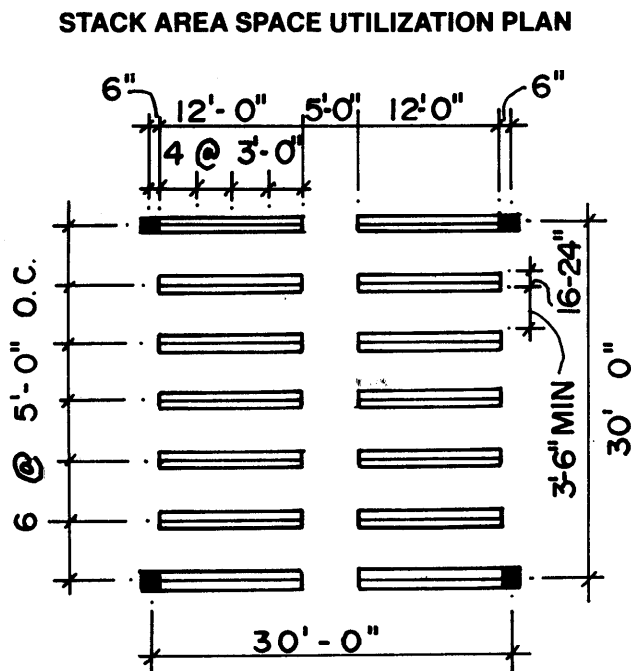

FIGURE 6-9

j. **READING AND STUDY AREAS.** Provide seating near fiction shelves for pleasure readers. Casual readers and patrons who need encouragement to read should have a reading area near the entrance, with new acquisitions, topical subjects, and paperbacks displayed nearby. Small seating groups for one to eight readers should be inter-

spersed with book stacks. Additional reading and study areas, not included in Table 6-13, should be located in the entrance-lobby, multi-purpose room, reference areas, and periodicals area. Suggested numbers of seats are given in the respective tables for these areas.

TABLE 6-13 READING AND STUDY AREAS SPACE REQUIREMENTS

Items	Unit Area Allowance	6250		10500		18000		20800		24000		30000	
		GSF	QTY	GSF	QTY	GSF	QTY	GSF	QTY	GSF	QTY	GSF	QTY
Lounge Seating	30/seat	18	540	22	660	42	1260	44	1320	50	1500	70	2100
Tables and Chairs	25/seat	15	375	22	550	36	900	44	1100	50	1250	70	1750
Carrels	30/seat	12	360	26	780	30	900	32	960	35	1050	40	1200
Total	45	45	1275	70	1990	108	3060	120	3380	135	3800	180	5050

k. **TYPING AND LISTENING BOOTHS.** Locate the typing and listening booths near the control area to facilitate checkout and supervision of equipment and materials.

Provide locks on doors (outside only) and 2 feet by 3 feet double glazed window in each booth for supervision and control (See Table 6-14.)

TABLE 6-14 TYPING AND LISTENING BOOTHS SPACE REQUIREMENTS

Items	Unit Area Allowance	6250		10500		18000		20800		24000		30000	
		GSF	QTY	GSF	QTY	GSF	QTY	GSF	QTY	GSF	QTY	GSF	QTY
Booths	36	2	72	2	72	3	108	4	144	5	180	5	180
Total			72		72		108		144		180		180

I. ADMINISTRATIVE LIBRARIAN'S (150 SQ FT) OFFICE

(1) *Activities and Participants.* The administrative librarian is responsible for the operation of the entire post library system, which includes the main library, branch libraries, the bookmobile, and all field library units. The administrative librarian's office must accommodate frequent meetings with library personnel and visitors.

(2) *Adjacencies.* Since the administrative librarian frequently requires typing services, a clerk typist should be adjacent. Access to technical services is required from this

office to facilitate general supervision. If possible, visitors should have direct access to this office without passing through staff, reading, or stack areas.

(3) *Special Considerations.* Informal, relaxing furnishings are suggested to create an atmosphere conducive to staff counseling. Exterior windows are desirable. The door(s) to this space requires lock(s). Provide sound isolation for confidential conversations.

(4) *Space Requirements.* See Table 6-15.

TABLE 6-15 ADMINISTRATIVE LIBRARIAN'S OFFICE SPACE REQUIREMENTS

Items	Unit Area Allowance	6250 GSF		10500 GSF		18000 GSF		20800 GSF		24000 GSF		30000 GSF	
		QTY	NASF	QTY	NASF	QTY	NASF	QTY	NASF	QTY	NASF	QTY	NASF
Office	150							1	150	1	150	1	150
Desk													
Armchair													
4 Side Chairs													
Credenza													
2 Sects. Shelving.													
Total									150		150		150

(5) Space Utilization Plan. See Figure 6-10.

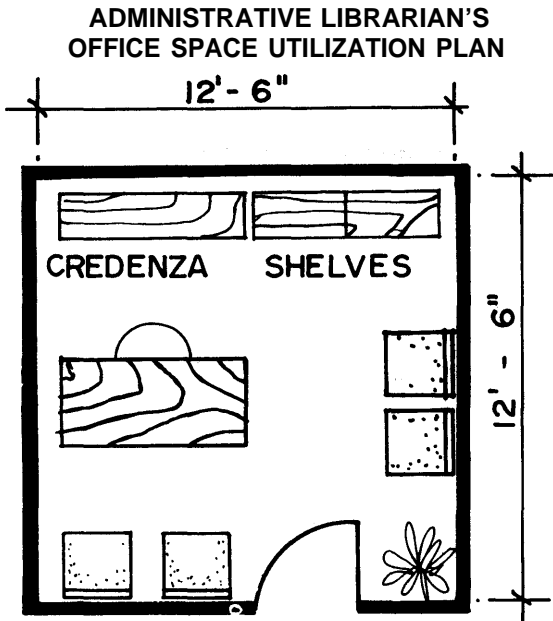

FIGURE 6-10

m. POST (SUPERVISORY) LIBRARIAN'S OFFICE (100 SQ FT). The post librarian is responsible for the operation of the main library, directs the operation of the control desk, the reference and children's areas, and frequently aids patrons in finding books and materials. This office should be adjacent to the control desk, which should be visible to the post librarian through a window or glass partition.

(1) Space Requirements. See Table 6-16.

TABLE 6-16 POST LIBRARIAN'S OFFICE SPACE REQUIREMENTS

Items	Unit Area Allowance	6250 GSF		10500 GSF		18000 GSF		20800 GSF		24000 GSF		30000 GSF	
		QTY	NASF	QTY	NASF	QTY	NASF	QTY	NASF	QTY	NASF	QTY	NASF
Office	100	1	100	1	100	1	100	1	100	1	100	1	100
Desk													
Chair													
Side Chair													
2 Sects. Shelv.													
12-Dwr File													
Total			100		100		100		100		100		100

(2) *Space Utilization Plan.* See Figure 6-11.

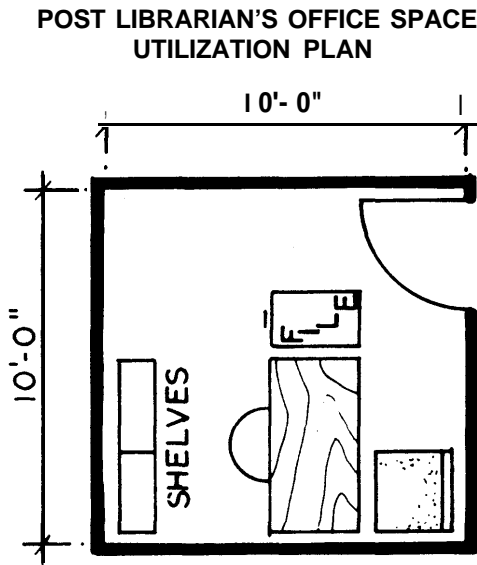

FIGURE 6-11

n. EXTENSION COLLECTION

(1) *Activities and Participants.* The extension collection is used primarily for the bookmobile service. The extension librarian is in charge of the extension collection, and is the supervisor of branch libraries, so books from the branches may occasionally be stored as part of the extension collection. Storage space may also be required for paperback kits stockpiled for issue.

(2) *Adjacencies.* This area should be located adjacent to the technical services area and near the bookmobile garage.

(3) *Special Considerations.* A window is desirable for the extension librarian. Provide double-faced compact shelving for 6000 books mounted on tracks for bookmobile. Provide one unit for each 250 volumes in the bookmobile reserve. Provide one unit for each 100 boxes of paperback kits stockpiled.

(4) *Environmental Criteria*

Mechanical: 6-8 air changes/hour

Electrical: intercom, 110V outlets, telephone

Lighting: daylight, 60 fc fluorescent general illumination

Acoustics: ambient PNC 40, generated 80 db, average sound quality

(5) *Finishes*

Floor: Vinyl asbestos tile

Walls: painted wallboard, plaster or concrete block, or vinyl covering

Ceiling: acoustical tile

(6) *Space Requirements.* See Table 6-17.

TABLE 6-17 EXTENSION COLLECTION SPACE REQUIREMENTS

Items	Unit Allowance	6250		10500		18000		20800		24000		30000	
		GSF	NASF	GSF	NASF	GSF	NASF	GSF	NASF	GSF	NASF	GSF	NASF
Extension Librarian	120	—	—	—	—	—	—	—	—	1	120	1	120
Desk													
Chair													
2-Dwr. File													
Book Truck													
2 Sects Shelvg.													
**Shelving, High	10	—	—	—	—	—	—	—	—	24	240	24	240
Density, Mobile													
Total				*	*	*	*				360		360

*Provide space for extension collection if bookmobile is operated or if more than one branch library is supported by the main library.

**Double-faced mobile, high density shelving measuring 37 inches by 26 inches by 84 inches high.

(7) *Space Utilization Plan.* See Figure 6-12.

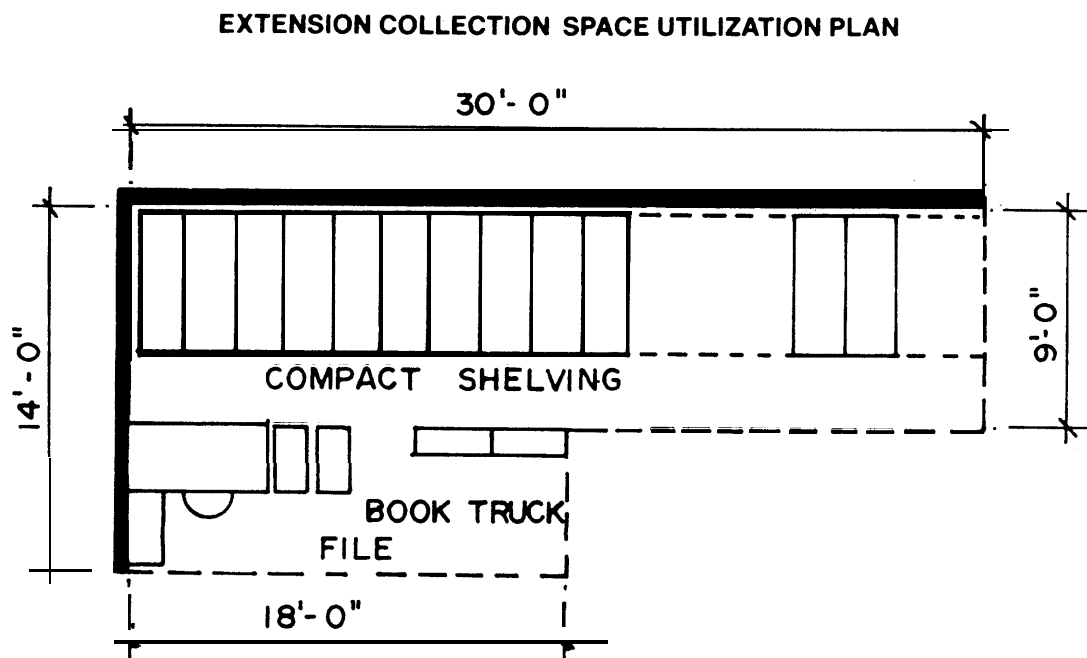

FIGURE 6-12

o. TECHNICAL SERVICES

(1) *Activities and Participants.* Technical services serves the entire post library system, including the main library, branch libraries, and the extension collection. In addition to desks and chairs, the following work stations are required:

(a) Card catalog to house master shelf list, authority files, on-order cards, etc. Provide one 30-tray unit per each 45,000 cards to be held.

(b) Index tables for bibliographic materials used for verifying publication data. Number to be determined by librarian.

(c) Work corner, which may include a drafting table and map case for preparation of displays, and a counter with a sink for minor book repairs.

(d) Book trucks for books in process. Provide storage space for one 5-shelf double-faced unit per each

300 volumes in processing, reserve stacks, and excess materials for disposal.

(e) Computer terminal

(2) *Adjacencies.* The office of the administrative librarian should have direct access to the technical services area. Required adjacencies also include shipping and receiving, the extension collection, the bookmobile garage, and the control area. It is desirable that the staff lounge and public card catalog be near the technical services area.

(3) *Special Considerations.* Provide ample window area. Provide thermostat. Semi-private work spaces should be provided using movable partitions. Drapes and carpeting should be furnished in work station areas. Heavy traffic floors may be vinyl asbestos tile.

(4) *Space Requirements.* See Table 6-18.

TABLE 6-18 TECHNICAL SERVICES SPACE REQUIREMENTS

Items	Unit Area Allowance	6250 GSF		10500 GSF		18000 GSF		20800 GSF		24000 GSF		30000 GSF	
		QTY	NASF	QTY	NASF	QTY	NASF	QTY	NASF	QTY	NASF	QTY	NASF
Work Stations	125	1	125	2	250	3	375	5	625	7	875	10	1250
Card Catalog	17	1	17	2	34	4	68	4	68	5	85	5	85
Book Index	50	—	—	—	—	1	50	1	50	2	100	2	100
Supply Cabinet	20	1	20	1	20	1	20	1	20	1	20	1	20
Drafting Table (incl Ref Table and Map Case)	125	—	—	—	—	—	—	—	—	1	125	1	125
Work Counter (incl sink)	5/lin ft	6	30	6	30	6	30	8	40	10	50	12	60
Shelving, mobile	12	4	48	9	108	9	108	10	120	12	144	15	180
Total			240		442		651		923		1399		1820

Note: Tabulated figures are based on staffing shown in Table 6-2. Number of work stations and actual space requirements should be based on actual authorized staffing levels. Space for administrative librarian, post librarian, and reference librarian should be programmed separately.

(5) Space Utilization Plan. See Figure 6-13.

TECHNICAL SERVICES SPACE UTILIZATION PLAN

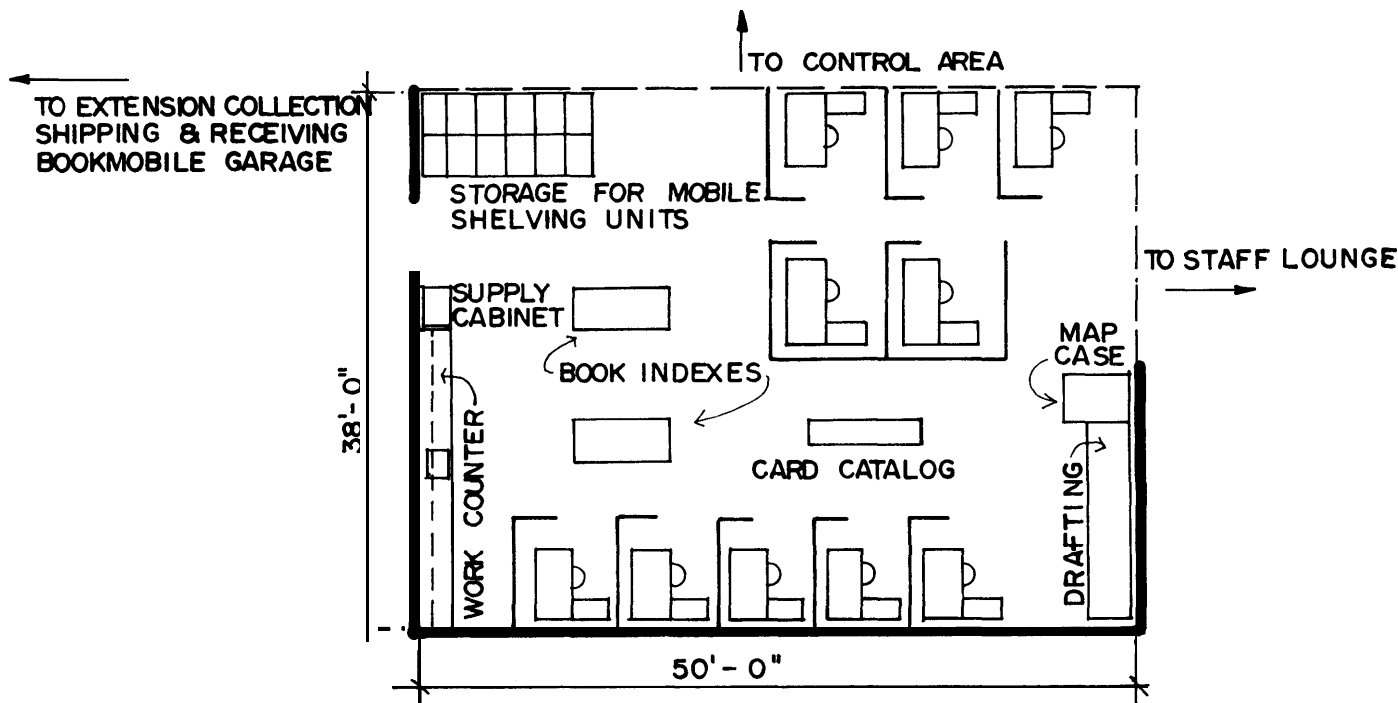

FIGURE 6-13

p. SHIPPING AND RECEIVING. The shipping and receiving area should be provided for storage, unpacking, sorting, and checking packages against invoices and packing lists. This area should be adjacent to the bookmobile garage, the extension collection, and technical services.

(1) Space Requirements. See Table 6-19.

TABLE 6-19 SHIPPING AND RECEIVING SPACE REQUIREMENTS

Items	Unit Area Allowance	6250 GSF		10500 GSF		16000 GSF		20600 GSF		24000 GSF		30000 GSF	
		QTY	NASF	QTY	NASF	QTY	NASF	QTY	NASF	QTY	NASF	QTY	NASF
Desk & Chair	50	—	—	—	—	1	50	1	50	1	50	1	50
Work Counter	50	—	—	—	—	1	50	1	50	1	50	1	50
Storage Bins	25	—	—	—	—	4	100	4	100	6	150	6	150
Loading Dock	2.5/lf	—	—	—	—	—	—	—	—	14	35	14	35
Total			*		*		200		200		235		235

* Combined with technical services

(2) Space Utilization Plan. See Figure 6-14.

SHIPPING AND RECEIVING SPACE UTILIZATION PLAN

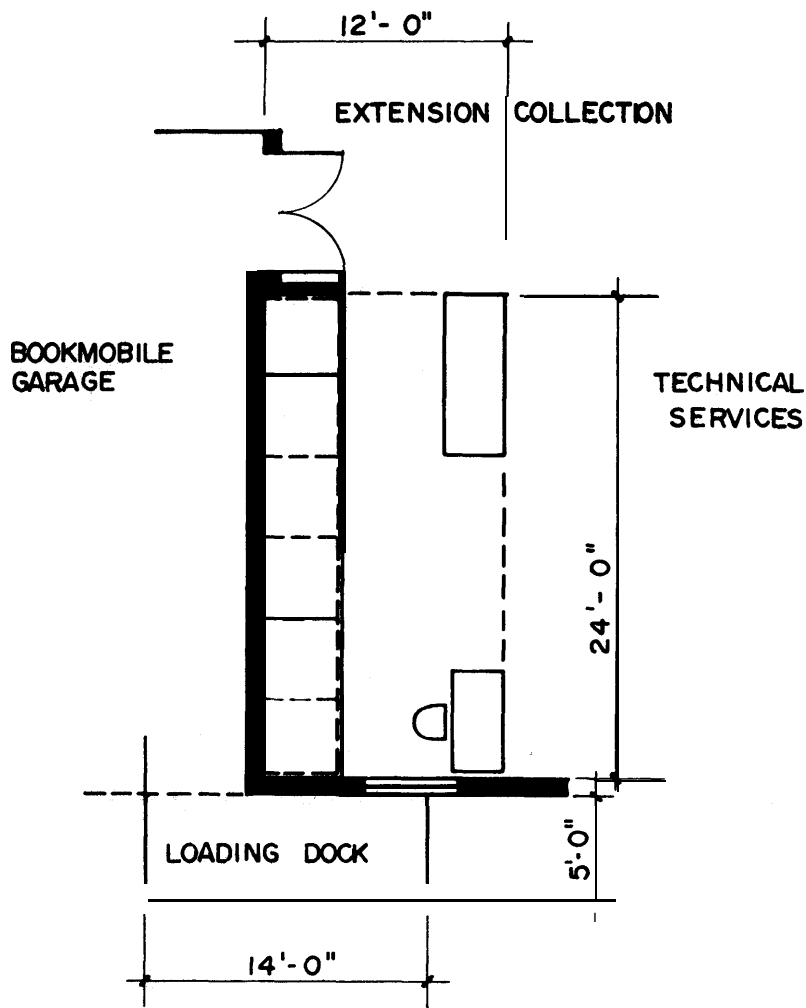

FIGURE 6-14

q. STAFF LOUNGE. The staff lounge provides kitchen support for meetings in the multi-purpose room and therefore should be adjacent, if possible, with direct access by a door which is lockable from the staff lounge.

(1) *Space Requirements.* See Table 6-20.

TABLE 6-20 STAFF LOUNGE SPACE REQUIREMENTS

Items	Unit Area Allowance	6250 GSF		10500 GSF		18000 GSF		20800 GSF		24000 GSF		30000 GSF	
		QTY	NASF	QTY	NASF	QTY	NASF	QTY	NASF	QTY	NASF	QTY	NASF
Sofa	75	—	—	—	—	1	75	1	75	1	75	1	75
Lounge Chairs	30	—	—	—	—	2	60	4	120	6	180	8	240
Chairs and Tables	25/seat	—	—	—	—	4	100	4	100	4	100	4	100
Unit Kitchen	80	—	—	—	—	1	80	1	80	1	80	1	80
Total			*		*		315		375		435		495

*Provide accommodations in technical services area

(2) *Space Utilization Plan.* See Figure 6-15.

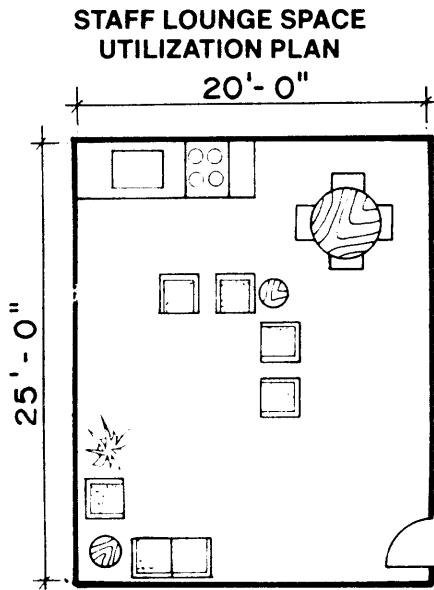

FIGURE 6-15

r. STAFF TOILETS. A single toilet for all staff members is sufficient for most libraries. Provide lockers for coats and belongings for staff without private offices. Locate the toilet near technical services which has the greatest concentration of staff. Entrances should be remote from public toilets entrances.

(1) *Space Requirements.* See Table 6-21.

TABLE 6-21 STAFF TOILETS SPACE REQUIREMENTS

Items	Unit Area Allowance	6250 GSF		10500 GSF		18000 GSF		20800 GSF		24000 GSF		30000 GSF	
		QTY	NASF	QTY	NASF	QTY	NASF	QTY	NASF	QTY	NASF	QTY	NASF
Washrooms	60	—	—	—	—	1	60	1	60	1	60	1	60
Lockers	6	2	12	4	24	6	36	6	36	8	48	18	108
Total			12		24		96		96		108		168

(2) *Space Utilization Plan.* Refer to plans in Chapter 4.

s. JANITOR'S CLOSET

(1) *Space Requirements.* See Table 6-22.

TABLE 6-22 JANITOR'S CLOSET SPACE REQUIREMENTS

Items	Unit Area Allowance	6250 GSF		10500 GSF		18000 GSF		20800 GSF		24000 GSF		30000 GSF	
		QTY	NASF	QTY	NASF	QTY	NASF	QTY	NASF	QTY	NASF	QTY	NASF
Janitor's Closet	100	1	100	1	100	1	100	1	100	1	100	1	100

(2) *Space Utilization Plan.* Refer to plan in Chapter 4.

t. BOOKMOBILE GARAGE. The bookmobile garage accommodates both the bookmobile and a loading dock for moving loaded book trucks to the bookmobile at a height convenient for loading. It can also serve as access between the shipping and receiving area and the outside loading dock. The bookmobile garage should be adjacent to the shipping and receiving area and the extension collection.

(1) *Special Considerations.* Most bookmobiles are loaded from the right side. Since it is preferable to drive straight in, rather than back in, the loading dock should be located on the right side of a parked truck. Space behind loading dock/ramp should be sufficient to insure maneuverability. Since bookmobiles are higher than most

vehicles, the clear height of the garage door must be verified against the maximum anticipated vehicle size.

(2) *Environmental Criteria*

- Mechanical: CW for hose, floor drain, exhaust, 6-8 air changes/hour
- Electrical: intercom, 220V and 110V outlets
- Lighting: 30 fc fluorescent
- Acoustics: ambient PNC 55, generated 90 db, live sound quality

(3) *Finishes*

- Floor: Concrete
- Walls: concrete block or exposed, paint optional
- Ceiling: exposed

(4) *Space Requirements.* See Table 6-23.

TABLE 6-23 BOOKMOBILE GARAGE SPACE REQUIREMENTS

Items	Unit Area Allowance	6250 GSF		10500 GSF		18000 GSF		20800 GSF		24000 GSF		30000 GSF	
		QTY	NASF	QTY	NASF	QTY	NASF	QTY	NASF	QTY	NASF	QTY	NASF
Bookmobile Garage	450	*		*		*		*		1	450*	1	450*
Total		*	—	*	—	*	—	*	—		450		450

*Only one garage of 450 square feet is authorized. If more than one bookmobile is operated, provide additional stalls without cover in service drive area. If winter design temperature for installation shown in TM 5-785 is 15°F or higher provide covered platform in lieu of garage

(5) *Space Utilization Plan.* See Figure 6-16.

BOOKMOBILE GARAGE SPACE UTILIZATION PLAN

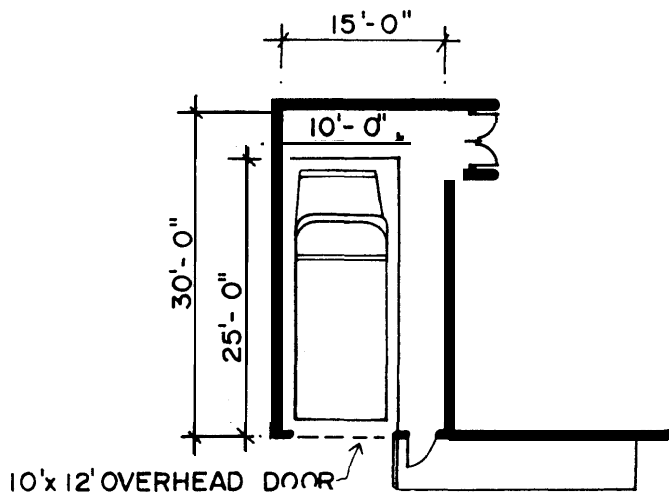

FIGURE 6-16

6-4 SUMMARY OF REQUIREMENTS AND CRITERIA

The following tables summarize the space requirements, environmental criteria, and finish materials covered in this chapter. Table 6-24 covers space requirements for six sizes of facilities. Table 6-25 summarizes environmental criteria. Table 6-26 summarizes recommended finish materials for each type of library space.

a. SUMMARY OF SPACE REQUIREMENTS. See Table 6-24.

TABLE 6-24 SUMMARY OF SPACE REQUIREMENTS

Space	6250 GSF	10500 GSF	18000 GSF	20800 GSF	24000 GSF	30000 GSF
	NASF	NASF	NASF	NASF	NASF	NASF
a. Entrance and Lobby	160	160	295	355	415	500
b. Multi-Purpose Room	—	—	1000	1000	1000	1000
c. Public Toilets	205	330	515	515	515	555
d. Public Card Catalog	51	102	204	255	306	340
Control Area	548	548	548	548	548	548
e. Reference Area	385	880	1420	1695	1925	2420
g. Periodicals Area	519	710	1137	1248	1378	1798
h. Children's Area	314	1289	1979	2621	3368	3949
i. Stack Area	1392	2086	3588	4033	4516	6236
j. Reading and Study Area	1425	2230	3420	3760	4225	5600
k. Typing and Listening Booths	72	72	108	144	180	180
l. Administrative Librarian	—	—	—	150	150	150
m. Post Librarian	100	100	100	100	100	100
n. Extension Collection	—	—	—	—	360	360
o. Technical Services	240	442	651	923	1399	1820
p. Shipping and Receiving	—	—	200	200	235	235
q. Staff Lounge	—	—	315	375	435	495
r. Staff Washroom and Lockers	12	24	96	96	108	168
s. Janitor's Closet	100	100	100	100	100	100
t. Bookmobile Garage	—	—	—	—	450	450
Total NASF	5,523	9,073	15,676	18,118	21,713	26,836
Core Area 15% + NASF	727	1,427	2,324	2,682	3,219	4,096
GSF	6,250	10,500	18,000	20,800	24,932*	30,932*

*932 sf extra is for extension collection and bookmobile garage

b. SUMMARY OF ENVIRONMENTAL CRITERIA. See Table 6-25.

TABLE 6-25 SUMMARY OF ENVIRONMENTAL CRITERIA

Space	Mechanical					Electrical					
	Thermostat	Air Changes/Hr	CW/HW	Central Vacuum	Floor Drain	Exhaust	Intercom	Outlets	PA	Telephone	TV Jack
a. Entrance and Lobby		6	(a)					110V	x	(b)	
b. Multi-Purpose Room	x	15		x				110V	x		x
c. Public Toilets		10	(e)		x	x		110V			
d. Public Card Catalog		6-8		x					x	x	
e. Control Area	x	6-8		x			x	110V	(g)	x	x
f. Reference Area		6-8		x			x	(h)	x	x	
g. Periodicals Area		6-8		x				(h)	x		
h. Children's Area	x	6-8	x	x	(m)	(m)	X	110V	x	x	x
i. Stack Area		6-8		x				110V	x		
j. Reading and Study Area		6-8		x				(h)	x		
k. Typing and Listening Booths		10						110V	x		
l. Administrative Librarian		6-8		x			x	110V	x	x	
m. Post Librarian		6-8		x			x	110V		x	
n. Extension Collection		6-8					x	110V		x	
o. Technical Services	x	6-8	(i)				x	110V	x	x	
p. Shipping and Receiving		6-8						110V		x	
q. Staff Lounge		6-8	(i)			x		110V	x	x	
r. Staff Washrooms and Lockers		10	(j)		x	x		110V	x		
s. Janitor's Closet		6	(i)		x	x		110V			
t. Bookmobile Garage			(i)		x	x		220V	x		

TABLE 6-25 SUMMARY OF ENVIRONMENTAL CRITERIA (CONTINUED)

Space	Lighting					Acoustics		Sound Quality
	Daylight	Fluorescent FC	Incandescent FC	Task (Fluor)	Task (Incan)	Ambient (PNC)	Generated (dB)	
a. Entrance and Lobby	X	60/10			(c)	40	80	AVG
b. Multi-Purpose Room			(d)		X	30	80	AVG
c. Public Toilets		30				45	80	ML
d. Public Card Catalog		60				30	75	MD
e. Control Area		60				35	80	MD
f. Reference Area		60				30	75	MD
g. Periodicals Area		60				35	75	MD
h. Children's Area	X	60				35	85	MD
i. Stack Area		60				35	75	MD
j. Reading and Study Area		60			X	30	70	MD
k. Typing and Listening Booths				X		30	80	D
l. Administrative Librarian	X	60				30	75	AVG
m. Post Librarian		60				30	70	AVG
n. Extension Collection	X	60				40	80	AVG
o. Technical Services	X	60		X		40	80	AVG
p. Shipping and Receiving		60				40	80	AVG
q. Staff Lounge	X	30		X	X	35	70	MD
r. Staff Washrooms and Lockers		30	(k)			45	80	AVG
s. Janitor's Closet		20				45	90	L
t. Bookmobile Garage	X	30				55	90	L

(a) Drinking Fountain

(b) Pay Telephone

(c) For Exhibits

(d) 60 fc Dimmer Switch

(e) Stop Sink

(f) 220V for Copy Machine

(g) Console

(h) 110V floor outlet

(i) Sink

(j) Sink and Water Closet

(k) Over Sink

(l) Hose

(m) In Toilets

c. SUMMARY OF FINISH MATERIALS. See Table 6-26.

TABLE 6-26 SUMMARY OF FINISH MATERIALS

Space	Floor						Wall						Ceiling				
	Carpet	Ceramic Tile	Concrete	Mats	Quarry Tile/Terrazzo	Vinyl Asbestos	Brick/Arch. Matis	Ceram Tile Wainscot	Wallboard/Plaster	Concrete Block	Acous Treatment	Exposed	Tack Board	Paint	Vinyl Covering	Acoustical Tile	Wallboard/Plaster
Entrance and Lobby			X	X		X		X	X	X		X			X		
Multi-Purpose Room	X							X	X	X		X	X	X			
Public Toilets		X			X			X	X				X			X	
Public Card Catalog	X		X	X				X	X	X					X		
Control Area	X		X	X		X		X		X					X		
Reference Area	X							X	X						X		
Periodicals Area	X							X	X				X		X		
Children's Area	X							X	X			X	X	X	X		
Stack Area	X							X	X				X		X		
Reading and Study Areas	X							X	X				X		X		
Typing and Listening Booths	X							X	X	X			X		X		
Administrative Librarian	X							X	X		X		X	X	X		
Post Librarian	X					X		X	X				X		X		
Extension Collection						X		X	X				X		X		
Technical Services						X		X	X			X			X		
Shipping and Receiving			X	X				X	X				X		X		
Staff Lounge	X							X	X				X	X	X		
Staff Washrooms and Lockers		X	X	X			X	X	X				X		X		
Janitor's Closet			X	X			X	X	X		X						X
Bookmobile Garage			X			X			X		X						X

6-5 SPACE ORGANIZATION

a. ADJACENCIES. Space numbers and names are shown in the left hand column of Table 6-27 and the number(s) of the adjacent spaces are listed to the right under the applicable criteria column. The resulting adjacency relationships are shown diagrammatically in Figure 6-17 with respect to organizing spaces into functional (building) layouts.

TABLE 6-27 IDENTIFICATION OF ADJACENCY RELATIONSHIPS

Space No.	Adjacent	Near 25	Near 75	Isolated
1. Entrance & Lobby	2,3,5,13	8	20	10,17,21
2. Multi-Purpose Room	1,3	5,8	18,20	6
3. Public Toilets	1,2	5	20	
4. Public Card Catalog	5,6	8,9,10,11,14,16	20	17,21
5. Control Area	1,4,14,16	2,3,6,7,8,12	9,10,11,20	17
6. Reference Area	4,7,10,11,14	5,9	20	2,17,21
7. Periodicals Area	6	5,9,11	10,20	17,21
8. Children's Area		1,2,4,5	20	10,11,17,21
9. Stack Area	10,11	4,6,7,16	5,20	1,17,21
10. Reading Area	6,9,11	4	5,7,20	8,17,21
11. Study Area	6,9,10	4	5,20	8,17,21
12. Typing and Listening Booths		4,5		
13. Administrative Librarian	1,16	14,15,18	20	
14. Post Librarian	5,6	4,16,18	20	
15. Extension Collection	16,17,21	13	20	
16. Technical Services	5,15,17,21	4,9,13,14,18	20	
17. Shipping and Receiving	15,16,21		20	1,5,6,7,8,9,10,11,18
18. Staff Lounge	19	13,14,16	2,20	17,21
19. Staff Washrooms and Lockers	16,18	13,14,15,17,20,21		
20. Janitor's Closet			20	
21. Bookmobile Garage	15,16,17		20	1,6,7,8,9,10,11,18

DIAGRAMMATICAL INTERPRETATION OF ADJACENCY RELATIONSHIPS

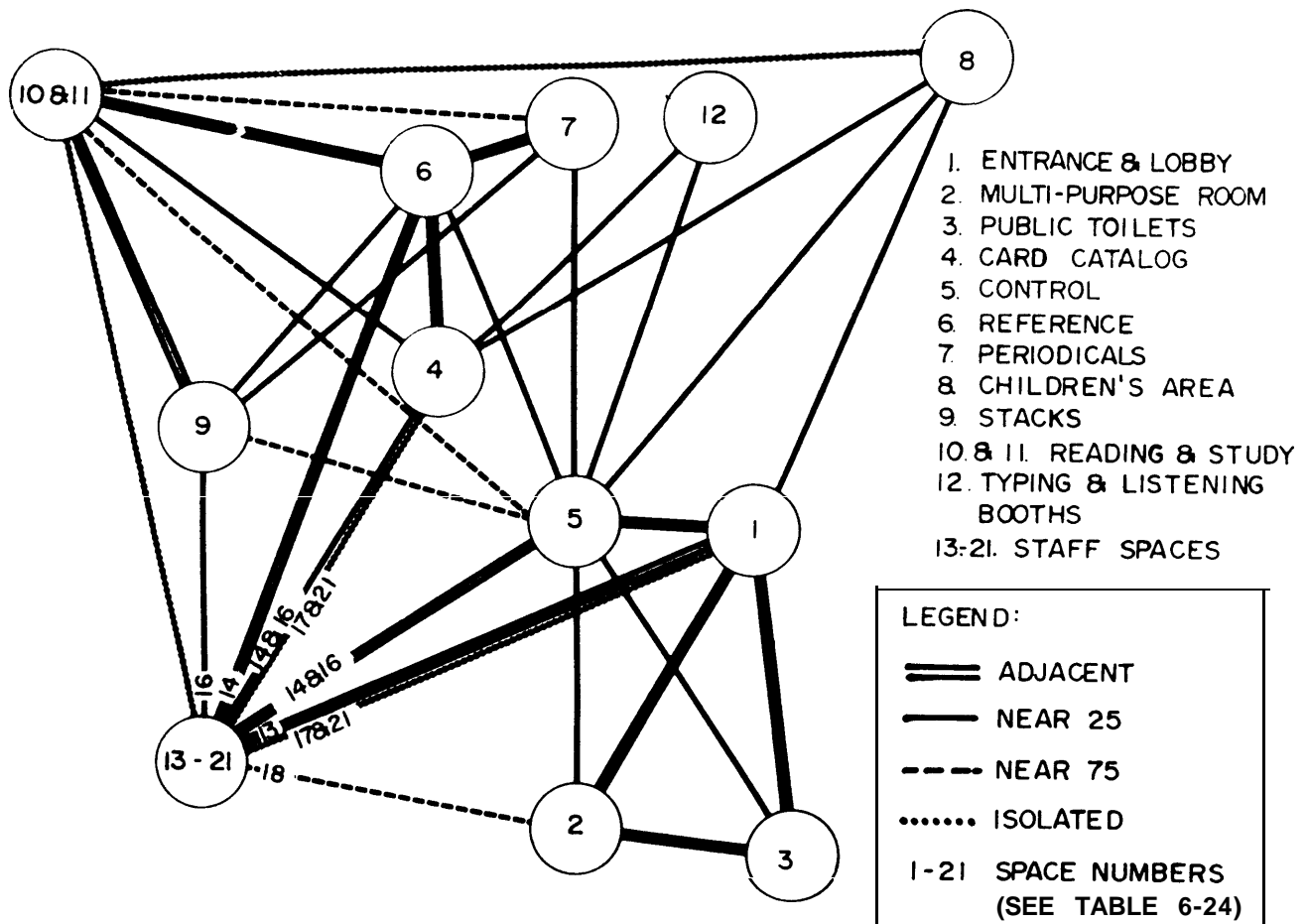

FIGURE 6-17

b. FUNCTIONAL GROUPS. Three distinct groups of spaces were identified in Paragraph 6-2.f(a). They were general use, public service, and staff spaces. Each one supports a common function established by need to provide optimum adjacency relationships.

(1) General use spaces include the entrance and lobby, multi-purpose room, and public toilets. These spaces must be organized to allow a transition from the exterior of the library into the interior control area. The organization of spaces into this group is shown diagrammatically in Figure 6-18.

GENERAL USE FUNCTIONAL GROUP (SPACES 1-3)

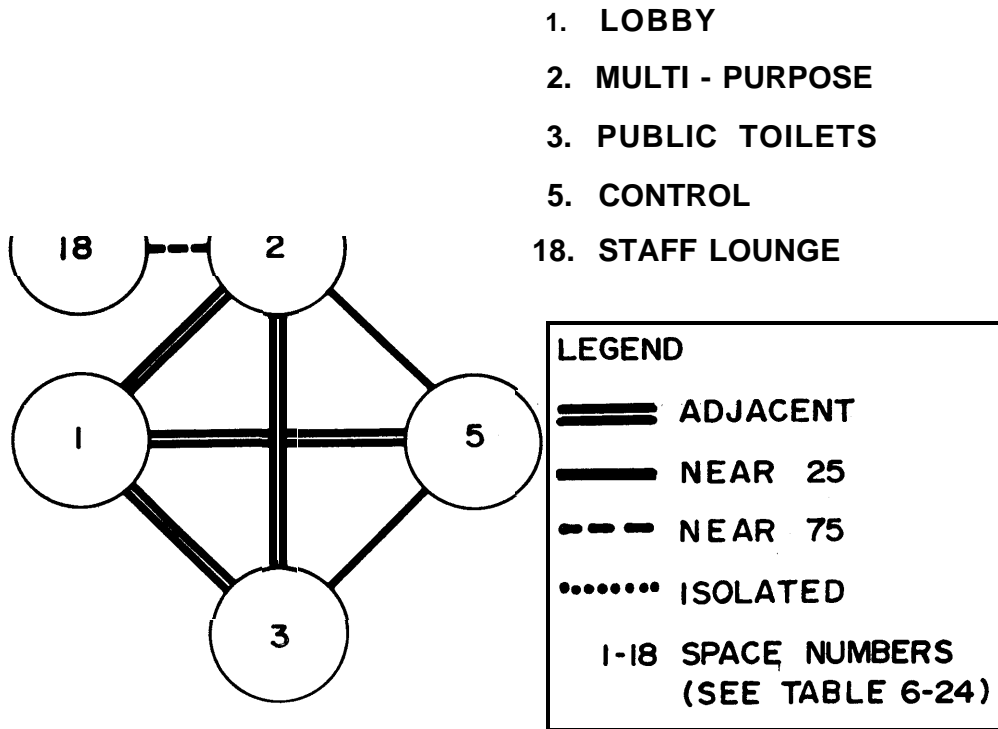

FIGURE 6-18

(2) Public service spaces include the control area, card catalog, reference and stack areas, reading and study areas, and the children's area. These spaces should be organized in an open fashion with reading areas interspersed with book stacks, all radiating out from the control area. This group of spaces is diagramed in Figure 6-19.

PUBLIC SERVICE FUNCTIONAL GROUP (SPACES 4-12)

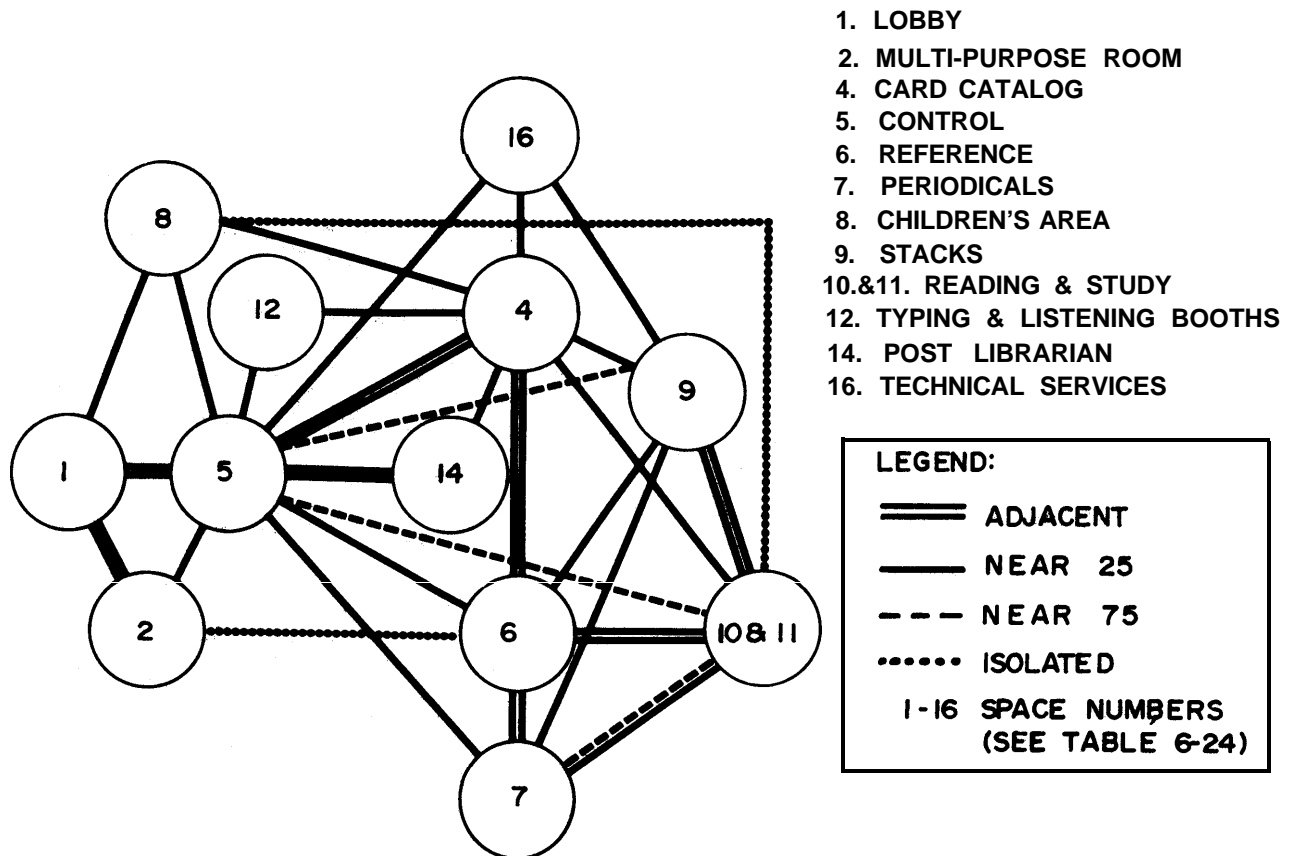
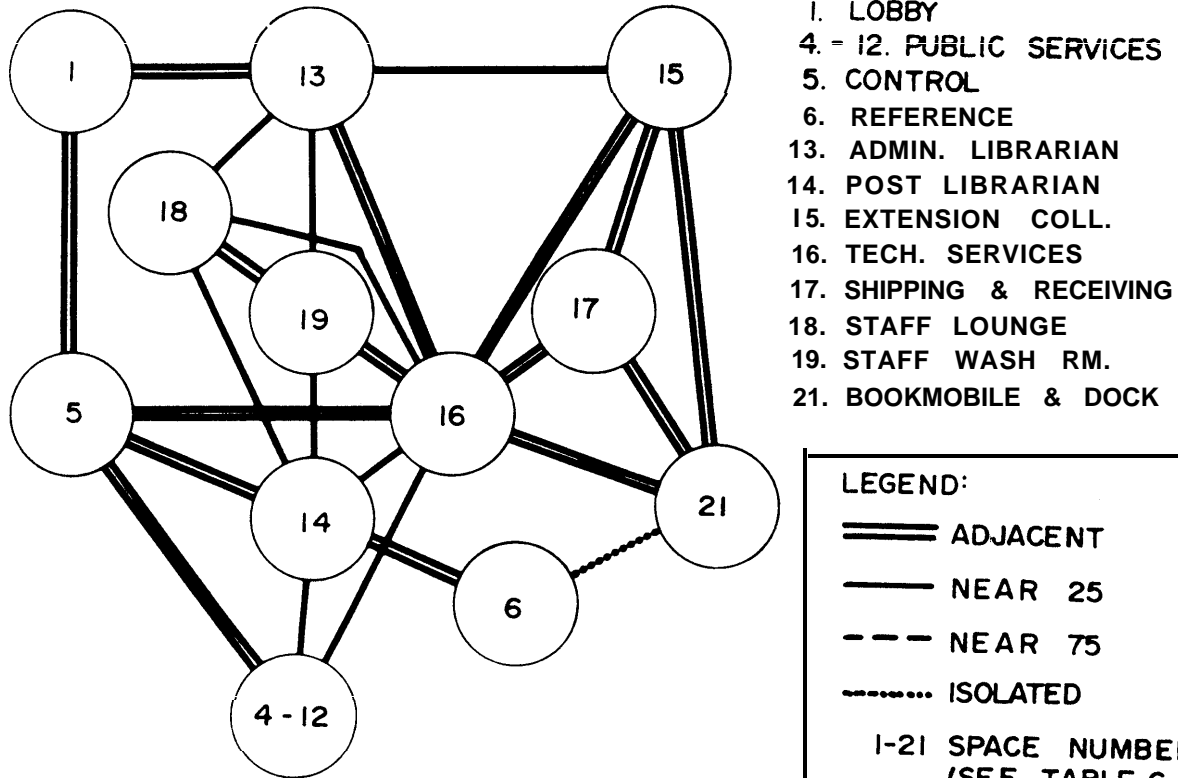

FIGURE 6-19

(3) Staff spaces include the technical services area, librarian offices, staff lounge, shipping and receiving area, bookmobile garage, and the extension collection. These spaces must be organized to maximize efficiency and communication. A diagrammatic representation of this group of spaces is shown in Figure 6-20. Figures 6-21, 6-22, and 6-23 show user flow, material flow, and staff flow.

STAFF SPACES FUNCTIONAL GROUP



LEGEND:

- ==== ADJACENT
- NEAR 25
- - - NEAR 75
- ISOLATED

I-21 SPACE NUMBERS
 (SEE TABLE 6-24)

FIGURE 6-20

USER FLOW

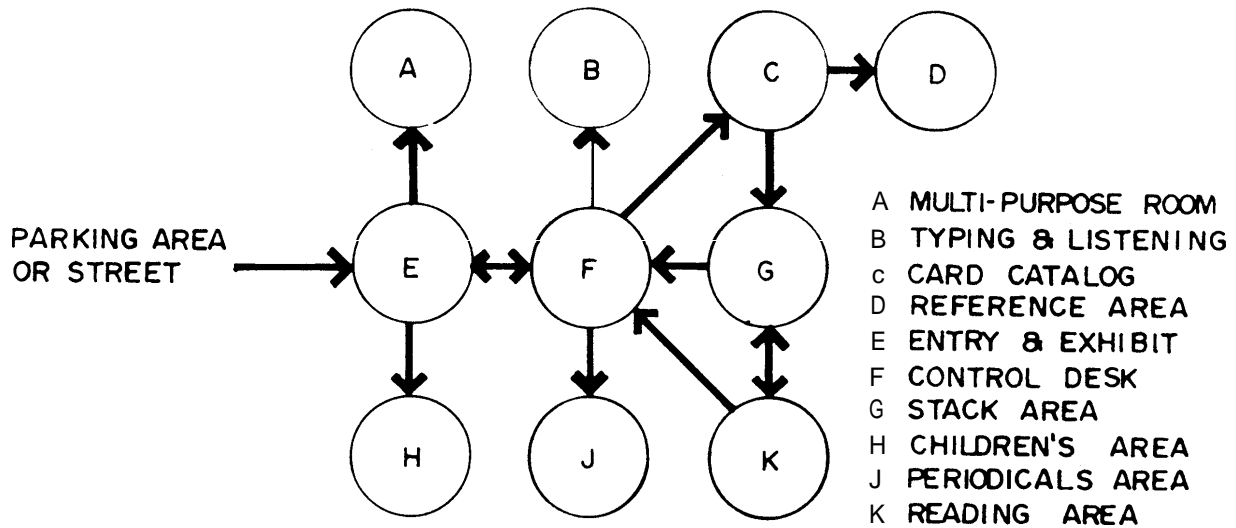

FIGURE 6-21

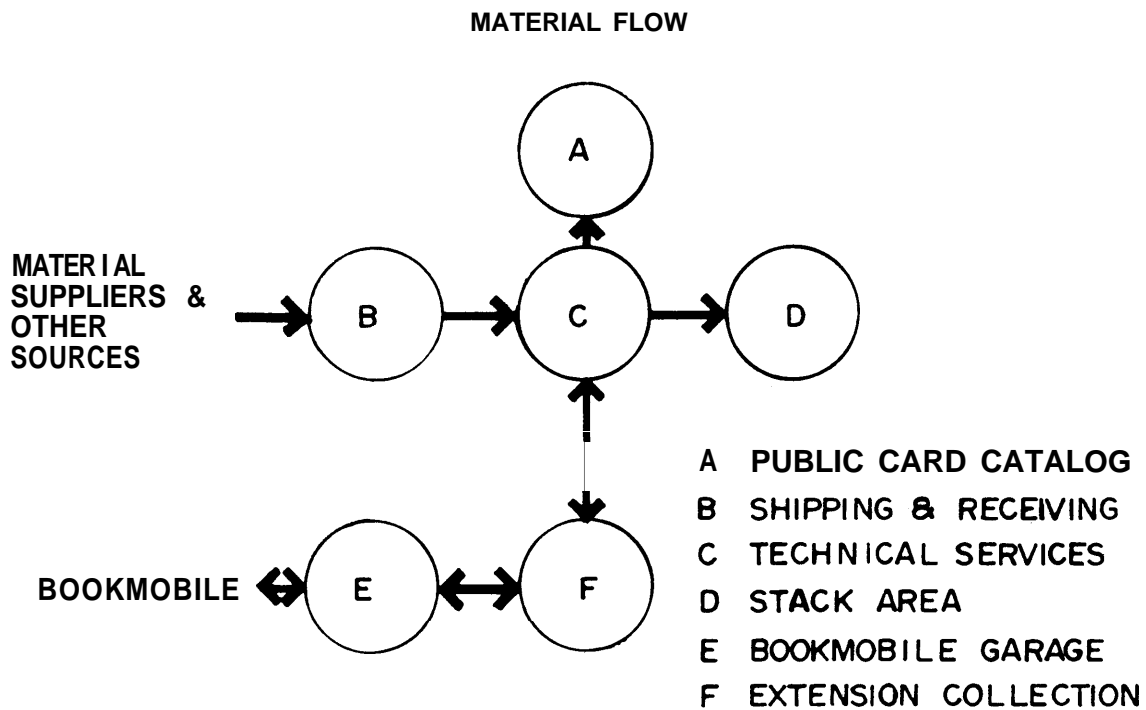

FIGURE 6-22

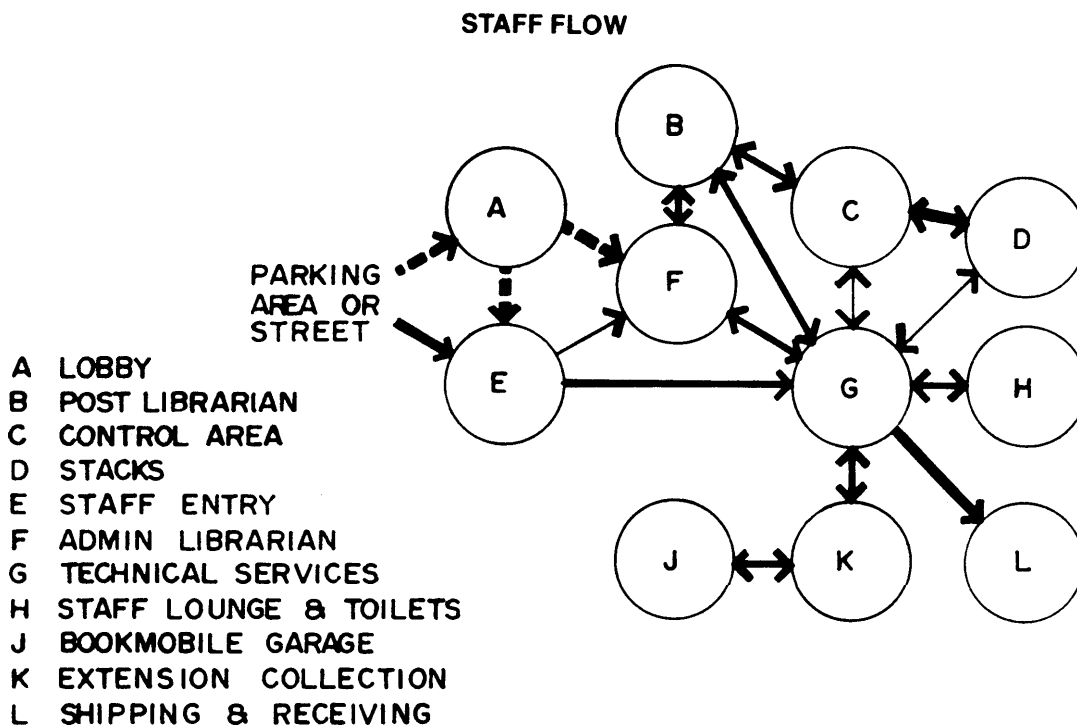

FIGURE 6-23

6-6 ILLUSTRATIVE CRITERIA APPLICATION

a. GENERAL. To illustrate the application of the foregoing criteria and principles, example designs for a 30,000 GSF MAX library are developed in this chapter. The first and most developed example is followed by five alternative designs which illustrate the effects of different site and climate conditions on space organization principles.

b. EXAMPLE DESIGN DEVELOPMENT

(1) *Planning Data.*

(a) *Military Strength.* The example design is located on a hypothetical post with a military strength of 22,000. (This military strength is authorized a main library of 30,000 GSF maximum by DOD).

(b) *Total Population.* The total population of the post is 44,000 (military, retired, and dependents).

(c) *Staffing.* As furnished by the Administrative Librarian, the actual personnel slots authorized for the main library are shown in Table 6-28.

TABLE 6-28 EXAMPLE STAFFING FOR POST POPULATION OF 44,000

8 Professionals:	Location:
1 Administrative Librarian	Private Office
1 Supervisory (Post) Librarian	Private Office
1 Technical Services Librarian	Technical Services
1 Cataloger Librarian	Technical Services
2 Reference Librarians	Reference Area
1 Extension Librarian	Extension Collection
1 Children's Librarian	Children's Area
13 Non-Professionals:	Location:
1 Administrator's Clerk-Typist	Technical Services
3 Clerk-Typists	Technical Services
4 Library Technicians	Technical Services
4 Library Technicians	Control Desk/Reference Desk
1 Warehouseman	Shipping/Receiving

(d) *Basic Collection and Auxiliary Materials.* Table 6-29 gives the breakdown for the actual basic and auxiliary collection at the post, as determined by the administrative librarian.

TABLE 6-29 BASIC AND AUXILIARY COLLECTION

Basic Collection	
Bound Volumes (Adult Collection)	59,000
Reference Volumes	5,100
Auxiliary Materials	
Documents and Pamphlets	—
Microfilm	3,000
Microfiche	3,000
Newspaper, Unbound	15
Newspaper, Bound	1,275
Periodicals, Unbound	300
Recordings	2,000
Maps	1,000
Slides	.
Total Collection	74,690

(e) *Extension and Bookmobile Services.* One bookmobile will be operated from the main library. The total extension collection will include approximately 10,000 volumes.

(2) *Space Allocation.* Based upon the program data stated above and utilizing unit area allowances covered in Chapters 2 and 3, space requirements can be developed for the collection, seating, services, and basic areas.

(a) *The Collections (Basic and Auxiliary).* Space requirements for the collection are derived by dividing the total number of items of each type (bound volumes, maps, etc.) by the number of volumes per storage unit to obtain the number of storage units. The number of storage units must then be multiplied by the NASF/unit to obtain the total area required, as shown in Table 6-30. All shelf units are considered as single-faced sections for this computation.

**TABLE 6-30 SPACE REQUIREMENTS FOR
EXAMPLE COLLECTION**

Type of Material	Quantity	Items/ Unit	No. of Units	NASF/ Unit	Total NASF
Control Desk					
Recordings	2,000	500	4	17	<u>68</u>
Subtotal					68
Reference Area					
Reference Vols.	5,100	75	68	10	680
Maps	1,000	1,000	1	40	40
Subtotal					720
Periodicals Area					
Microfilm	3,000	400	8	11	88
Microfiche	3,000	10,000	1	11	11
Newspapers, Unbound	15	7	3	13	39
Periodicals, Unbound	300	15	20	10	<u>200</u>
Subtotal					338
Stack Area					
Bound volumes	59,000	125	479	9	4,311
Bound newspapers	1,275	9	142	11	<u>1,562</u>
Subtotal					5,873
Total NASF Basic and Auxiliary Collections					6,999

(b) *Seating*. Based on the unit area allowance covered in Chapter 2 (total SF for adult collection x 1.15 ÷ 30 SF/seat), approximately 305 seats are required. The seats are distributed in accordance with Table 6-31.

(c) *Services*. Space requirements for services are derived as shown in Table 6-32 by computing the required area for each function based on the consideration and factors developed in Chapter 4, Individual Space Criteria.

TABLE 6-31 SPACE REQUIREMENTS FOR ADULT SEATING

NASF/ seat	Type of Seat	Multi- Purpose Room	Refer- ence Area	Perio- dicals Area	Reading & Study Areas	Typing & Listening Booths	Total
25	Open Tables		30		60		90
30	Small Carrels				60		60
40	Research Carrels						
40	AV Carrels			4			4
30	Typing Booths					5	5
30	Lounge Chair	10		41	60		111
25	Small Group Seating		30				30
Total Seats		10	60	45	180	5	300
Total NASF		300	1500	1510	5100	150	8560

TABLE 6-32 SPACE REQUIREMENTS FOR SERVICES

Item	Units	NASF/ Unit	NASF
Multi-Purpose Room			
Conf. Table, Chairs	10	25	250
Portable Seating	20	20	400
Storage			50
Subtotal Multi-Purpose Room			700
Public Toilets			
Men's WC	6	25	150
Men's Urinals	3	25	75
Men's Lavatory	6	15	90
Women's WC	6	25	150
Women's Lavatory	6	15	90
Subtotal Public Toilets			555
Public Card Catalog (65,000 vol. ÷ 3,000 vol/unit)	22	17	374
Subtotal Public Card Catalog			374
Reference Area			
Reference Librarian	2	150	300
Subtotal Reference Area			300
Children's Area			
Collection (20,000 vol. ÷ 85 vol/unit)	235	11	2585
Seating (25% x 2561 SF = 640 SF)	32	20	640
Children's Librarian	1	125	125
Children's Toilets	2	50	100
Cushions	20	15	300
Storage (2% Total NASF)	1	75	75
Card Catalog (20,000 vol ÷ 30,000 vol/unit)	7	17	119
Subtotal Children's Area			3944
Extension Collection			
Shelving, Movable (60,000 vol. ÷ 250 vol/unit)	24	10	240
Extension Librarian	1	120	120
Subtotal Extension Collection			360

Technical Services			
Work Stations	10	100	1000
Shelf List	5	17	85
Book Index	2	50	100
Supply Cabinet	1	20	20
Drafting Table	1	125	125
Work Table	12	5/LF	60
Shelving, Movable (4,500 vol. ÷ 300 vol/unit)	15	12	180
Subtotal Technical Services			1570
Total NASF			7803

(d) *Basic Space Requirements.* From the individual requirements tables in this chapter for a 30,000 SF library, the basic space requirements are obtained for the spaces listed in Table 6-33.

TABLE 6-33 BASIC SPACE REQUIREMENTS

Entrance and Lobby	500
Control Area	458
Administrative Librarian	150
Post Librarian	120
Shipping and Receiving	320
Staff Lounge	495
Staff Washrooms & Lockers	168
Janitor's Closet	100
Bookmobile Garage	450
Total NASF	2761

(e) *Summary of Space Requirements.* Table 6-34 summarizes space requirements for the staff, the collection, seating and other activities by type of space. The description of each of these requirements can be found in this chapter. Finally, the total requirements for each space are listed in the last column.

(3) *Site Characteristics.*

(a) *Topography.* The site is flat except near the street intersection where it slopes gently to the southeast. (See Fig. 6-25.)

TABLE 6-34 EXAMPLE TOTAL SPACE REQUIREMENTS

Space	Collection	Seating	Services	Basic	Total
Entrance and Lobby				500	500
Multi-Purpose Room		300	700		1,000
Public Toilets			555		555
Public Card Catalog			374		374
Control Area	68			458	526
Reference Area	720	1,500	300		2,520
Periodicals Area	338	1,510			1,848
Children's Area			3,944		3,944
Stack Area	5,873				5,873
Reading and Study Area		5,100			5,100
Typing & Listening Booths		150			150
Administrative Librarian Supervisory (Post)				150	150
Librarian				120	120
Extension Collection			360		360
Technical Services			1,570		1,570
Shipping & Receiving				320	320
Staff Lounge				495	495
Staff Washrooms & Lockers				168	168
Janitor's Closet				100	100
Bookmobile Garage				450	450
Total NASF	6,999	8,560	8,147	2,761	26,123 NASF
Approximate Size of Library	26,123		× 1.15 =		30,041 GSF
Approximate Size of Mech Room			=		1,200 GSF
Total Building Requirement			=		31,241 GSF

(b) *Area Available.* The site consists of approximately 5 acres, which is adequate for a single-story building and parking.

(c) *Climate.* This installation is located in a temperate climate, with an outdoor design temperature of 88 degrees F in summer and 8 degrees F in winter.

(d) *Utilities.* Electrical power and water and sewage lines are available along the southern edge of the site.

(e) *Vegetation and Unique Features.* A row of evergreen trees is located perpendicular to the east-west street and can serve as a windbreak against the cold winter winds. Scattered deciduous trees, located in the corner of the lot, can provide shade in the summer.

(4) *Functional Layout.*

(a) *Functional Grouping.* Figure 6-17 is a diagrammatical interpretation of the basic adjacency relationships which are required in all main libraries. These are developed in greater detail in Figures 6-18, 6-19, and 6-20 which depict functional groups for general use, public

service and staff.

An obvious architectural form is suggested for the building, comprising three major functional groupings:

- Stack, reading, and reference spaces
- Technical processing and staff spaces
- Multi-purpose, toilets and mechanical space

Functions that must serve two of the three major groupings—the lobby and the card catalog/control area—can be juxtaposed between the groupings to which they relate. The primary modification to this basic layout is the insertion of the multi-purpose room adjacent to the staff lounge and in proximity to the reading and study area to enhance its two functions as a public meeting room and a reading and study area. Another modification to the basic scheme is the identification of the children's area as a separate entity connected to the main post library only at the lobby. This scheme is shown in Figure 6-24, Functional Requirements Diagram. In this diagram, the actual area requirements are shown proportionately, and organized so as to conform to the adjacency relationships listed in Table 6-27.

FUNCTIONAL REQUIREMENTS DIAGRAM

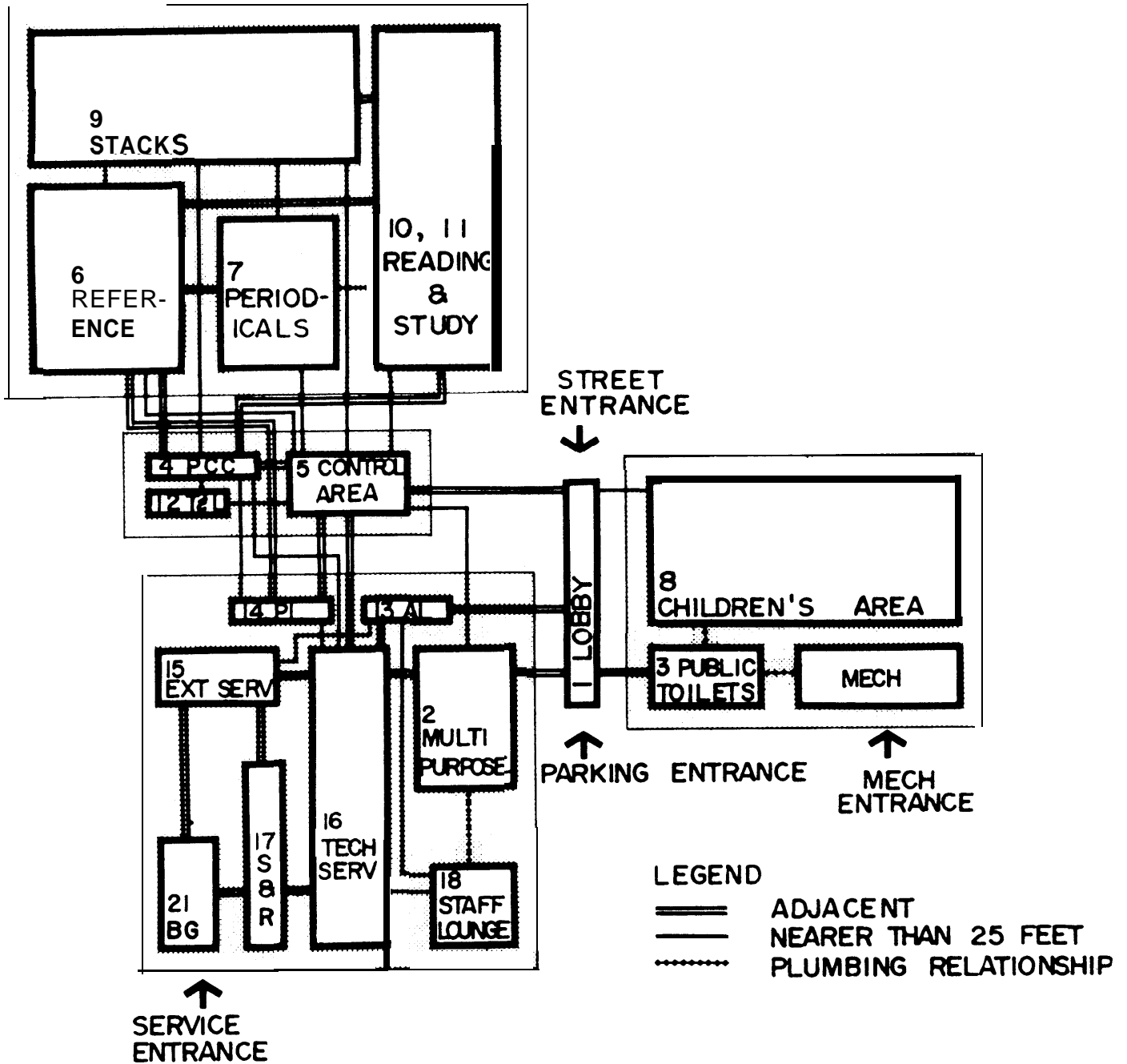

FIGURE 6-24

(b) *Circulation.* Spaces can be arranged within the three major groupings to conform to the flow of users, materials and staff diagrammed in Figures 6-18, 6-19, and 6-20. The spaces most likely to be used by the physically handicapped such as the toilets, children's areas, multipurpose room, card catalog, and listening booths, may be located directly adjacent to the major circulation areas (i.e., the lobby and control area).

(c) *Acoustic Privacy.* The arrangement of the building into three major groups separated by the circulation areas accomplishes most of the requirements for acoustic isolation shown in Table 6-27. Within the groups, the staff lounge is the only space requiring further isolation. This can be handled by locating it in a corner away from other activities and applying acoustic barriers, if necessary.

(5) *Site Constraints.* The flat, ample site offers no constraints to the building layout. The building may be sited within the existing tree cover to control sun and wind expo-

sure; the axis of the building can be oriented east and west to minimize energy consumption. The mild climate imposes no further constraints on the shape of the building, allowing development in an ideal functional form, with ample opportunity to freely develop indoor/outdoor connections and site support items. (See Fig. 6-25.)

(6) *Visual Control.* Visual control can be achieved by situating the main collection and reading areas in a large open room and locating the control area as a connecting space between the collection area and the lobby. This allows the control area personnel to monitor activities in the stack and reading areas, as well as the multipurpose rooms, toilets, and exits.

(7) *Modular Layout.* By virtue of the large, open areas, the spaces and buildings can be readily organized into 30-foot by 30-foot structural modules, allowing for possible change in use and for expansion. This is expressed in Figure 6-26. Spaces requiring plumbing or separate heating and air conditioning zoning are clustered.

EXAMPLE SITE PLAN

SOUTH-SOUTHEAST SUMMER BREEZES

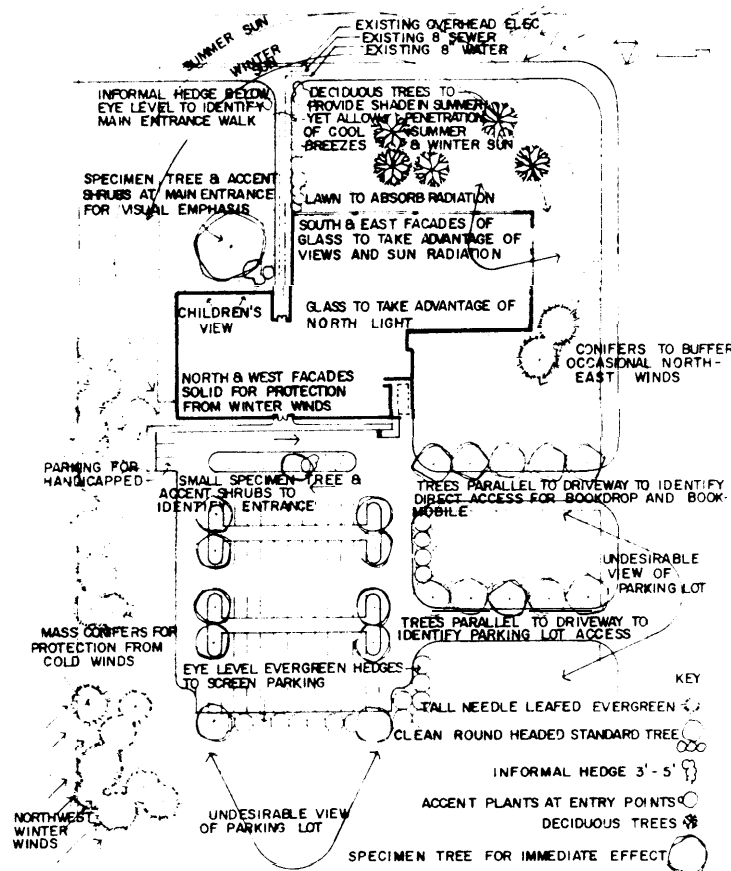

FIGURE 6-25

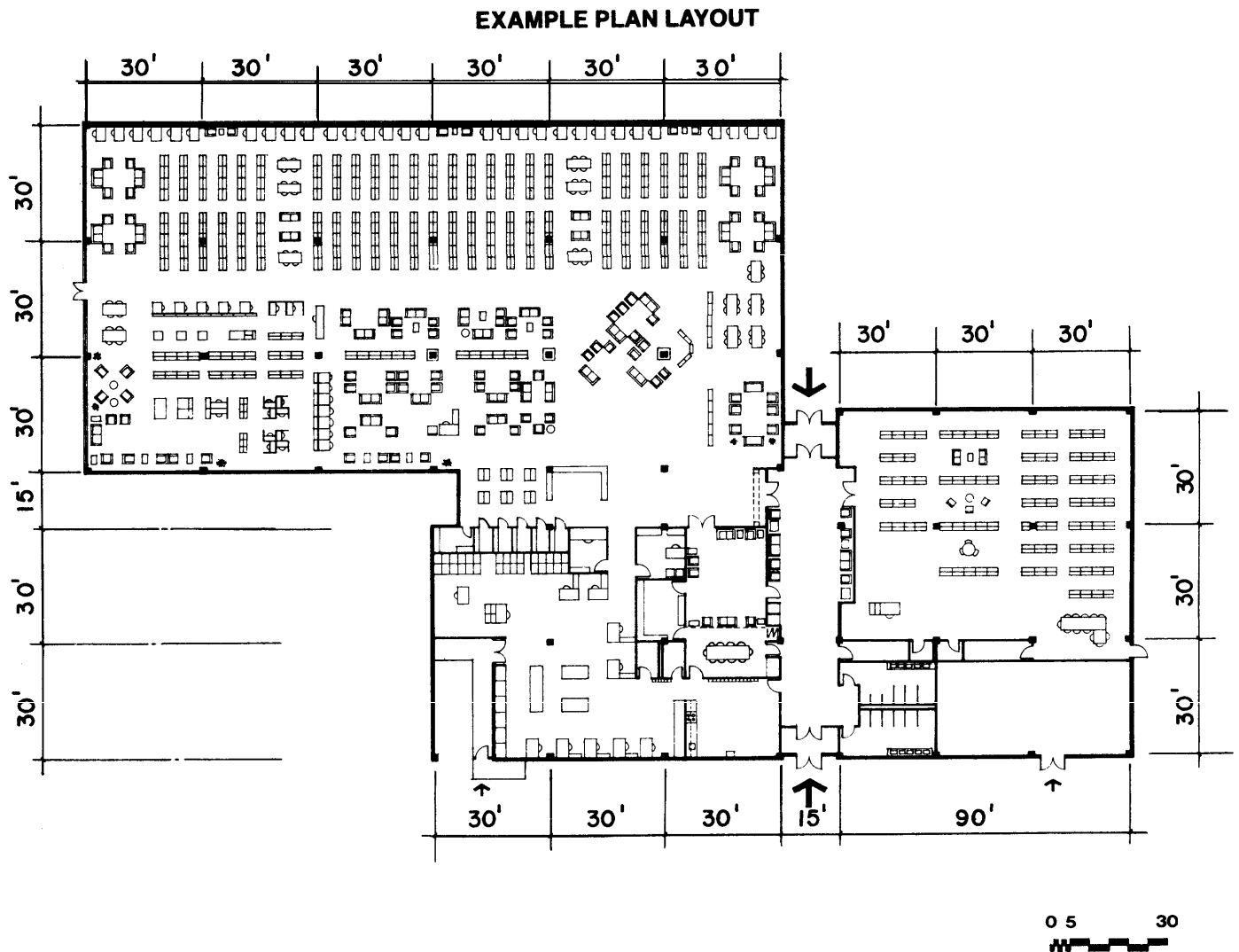

FIGURE 6-26

c. EXAMPLE DESIGN NO. 2, 30, 000 GSF LIBRARY

(1) *Planning Data.* The mission, staff and collection requirements in this example are the same as in example design No. 1, paragraph b(1) above.

(2) *Space Allocation.* The space allocation requirements in this example are the same as in example design No. 1, paragraph b(2) above.

(3) *Site Characteristics.*

(a) *Topography.* The site is flat and narrow with street access on the short north side. Adjacent buildings block views. Size of the lot is barely adequate for the library and a small parking lot.

(b) *Climate.* The climate is hot and dry in summer, cold in winter. Vegetation is sparse with intense radiation and high cooling loads in summer.

(4) *Functional Layout.* The building can be organized into the same functional grouping as shown in Figure 6-24. All staff areas can be grouped for maximum operational efficiency and the general use areas can be grouped around the lobby to afford convenient control of after-hours utilization. Circulation must be provided from the lobby through the control area to the stack and reading areas. Acoustical privacy can be achieved by interposing

circulation and storage space between the functional groups and providing acoustical barriers where required.

(5) *Site Constraints.* The long, narrow site forces Figure 6-24 to be modified into a similar configuration. Since both the street and the parking and driving area must be confined to the north side of the building, the entrance, the bookmobile garage, and the mechanical equipment room must be located there. The resulting functional requirements diagram locates both the staff and general use groups on the street side, separated by the lobby, with large stack and reading areas in the rear, isolated from street noise. The hot, dry climate would require a southerly exposure on a larger site, but this is impossible here. Protection from the sun can be furnished by large trees and planting the east and west sides and minimization of windows.

(6) *Visual Control and Interest.* Visual control can be achieved using the same principles as in example design No. 1. Visual interest can be provided by windows opening to a small landscaped courtyard along the east side of the building.

(7) *Modular Layout.* As in example design No. 1., the spaces may be organized within 5-foot by 5-foot modules and 30-foot by 30-foot or 25-foot by 30-foot structural bays. This is expressed in Figure 6-27. Spaces which are unlikely to change or require permanent partitions, such as the toilets, mechanical equipment room, and bookmobile garage, are clustered to allow the remainder of the library to be flexible to changing requirements and expansion. Spaces which may operate during off-hours or limited hours are clustered to permit zoning of heating and air-conditioning. Spaces requiring plumbing are grouped together for economy.

FLOOR PLAN. EXAMPLE DESIGN NO. 2

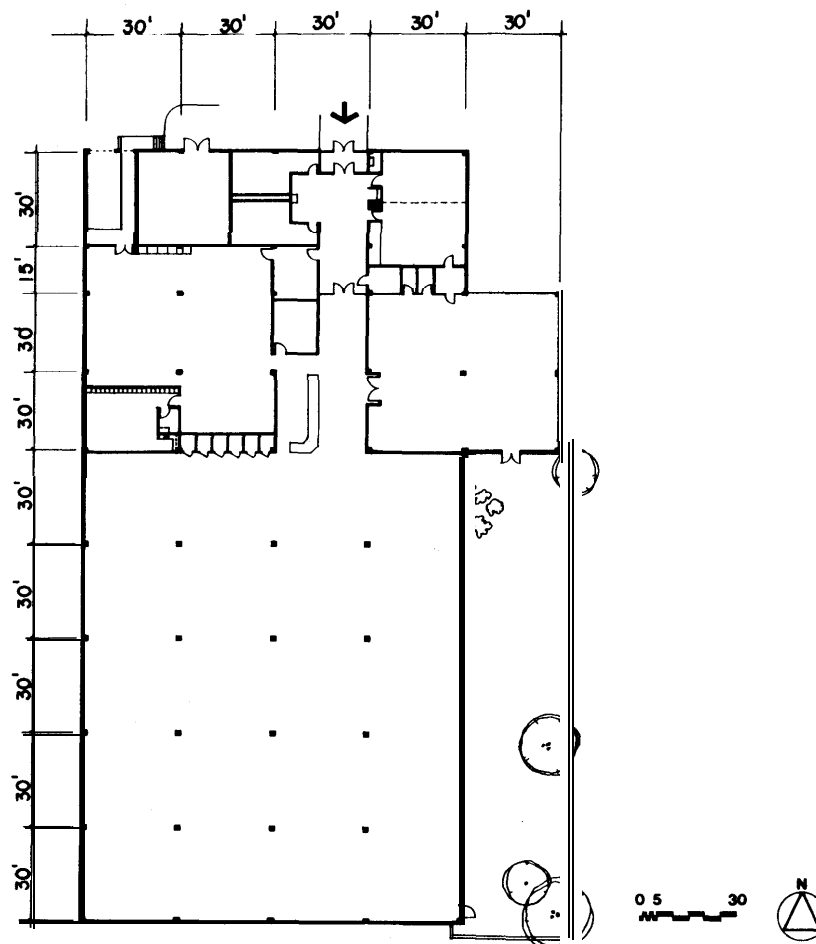

FIGURE 6-27

d. EXAMPLE DESIGN NO. 3, 30,000 GSF LIBRARY

(1) *Planning Data.* This mission, staff, and collection requirements in this example are the same as in example design no. 1, paragraph b(1) above.

(2) *Space Allocation.* The space allocation requirements in this example are the same as in example design No. 1, paragraph b(2) above.

(3) *Site Characteristics*

(a) *Topography.* This building is on a large corner site, sloping gently to the east. The view to the east is of World War II temporary barracks. On the rise to the west is a gun emplacement dating from 1842, a focal point of post ceremonies and esprit de corps.

(b) *Climate.* As in example design No. 2, the climate is hot and dry in the summer and cold in the winter.

(4) *Functional Layout.* The building can be organized into the same functional grouping shown in Figure 6-24. All staff spaces can be grouped for maximum operational efficiency and the general use areas can be grouped around the lobby for control of after-hours utilization. Circulation must be provided from the lobby through the control area to the stack and reading areas. Acoustical privacy can be achieved by interposing circulation and storage space between the functional groups and providing acoustical barriers where required.

(5) *Site Constraints.* The climate and unattractive views suggest an inward oriented facility. Figure 6-24 can be revised to organize the public use spaces around a central courtyard. The desirability of not obscuring or detracting from the historic site suggests that the building can be set into the slope, which will also benefit from the insulation of the earth.

(6) *Visual Control and Interest.* Visual control can be achieved using the same principles as in example design No. 1. Visual interest is achieved by windows opening onto the courtyard and by the succession of spaces and focal points which occur as the user moves through the lobby, turns at the control desk, walks past the courtyard, and turns again into the large reading and study area.

(7) *Modular Layout.* As in the preceding examples, the spaces can be organized into 5-foot by 5-foot modules. Because of the effect of the site on the layout, the structural grid is less uniform than in other examples. The 30-foot bay spacing can be maintained in the stack area. As in the other examples, the general use group and spaces requiring plumbing are clustered for economy. (See Fig. 6-28.)

FLOOR PLAN, EXAMPLE DESIGN NO. 3

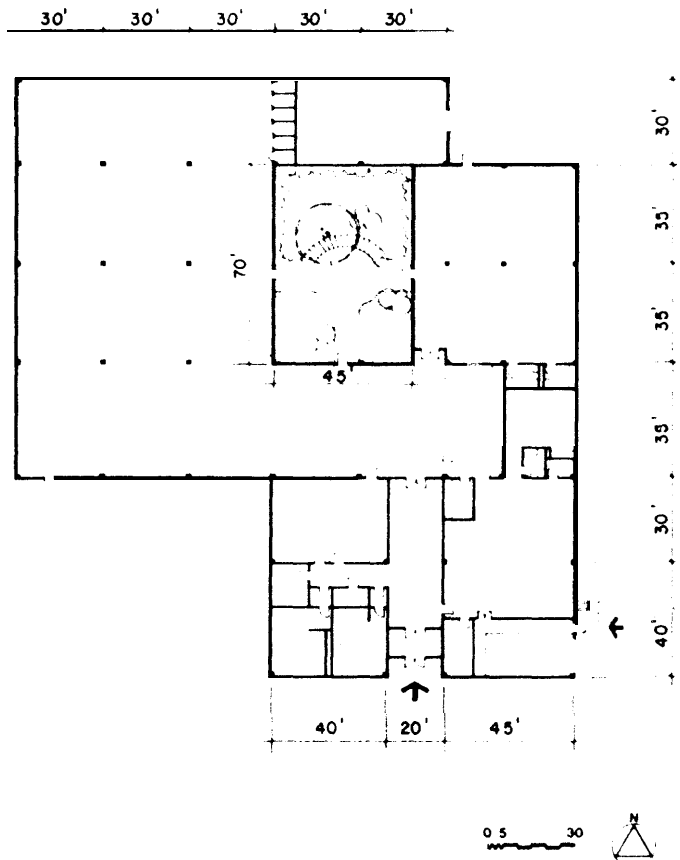

FIGURE 6-28

e. EXAMPLE DESIGN NO. 4, 30,000 GSF LIBRARY

(1) *Planning Data.* The mission, staff, and collection requirements in this example are the same as in example design No. 1, paragraph b(1) above.

(2) *Space Allocation.* The space allocation requirements in this example are the same as in example design No. 1, paragraph b(2) above.

(3) *Site Characteristics.*

(a) *Topography.* The site is flat and very small, defined by a new GED Center on the west, a primary thoroughfare on the north, and a secondary road on the east. The existing parking for the GED Center is to be extended to accommodate the library patrons.

(b) *Climate.* The climate is hot and humid and subject to occasional hurricanes.

(4) *Functional Layout.* Staff spaces are grouped for operational efficiency. General use areas are grouped around the lobby for after-hours control. The street entrance opens directly to the control area for use during

normal hours. The lobby opens to the parking lot, rather than the street, to accommodate the majority of users during normal hours and after-hours. Public toilets are stacked on two floors for convenience and economy.

(5) *Site Constraints.* The limited site area requires a two story scheme. The reading and stack group is slightly larger than the combined area of the other spaces so the periodicals area and some reading and study space are located on the ground floor with the staff and general use groups. The adult stack and reading areas are on the floor above

(6) *Visual Control.* Visual control of reading/stack and general use areas is impossible from a single station in a two-story scheme. The control desk, therefore, controls the first floor and the reference librarian controls the second floor.

(7) *Modular Layout.* The layout conforms to the 5-foot by 5-foot module (See Fig. 6-29.)

FLOOR PLAN, EXAMPLE DESIGN NO. 4

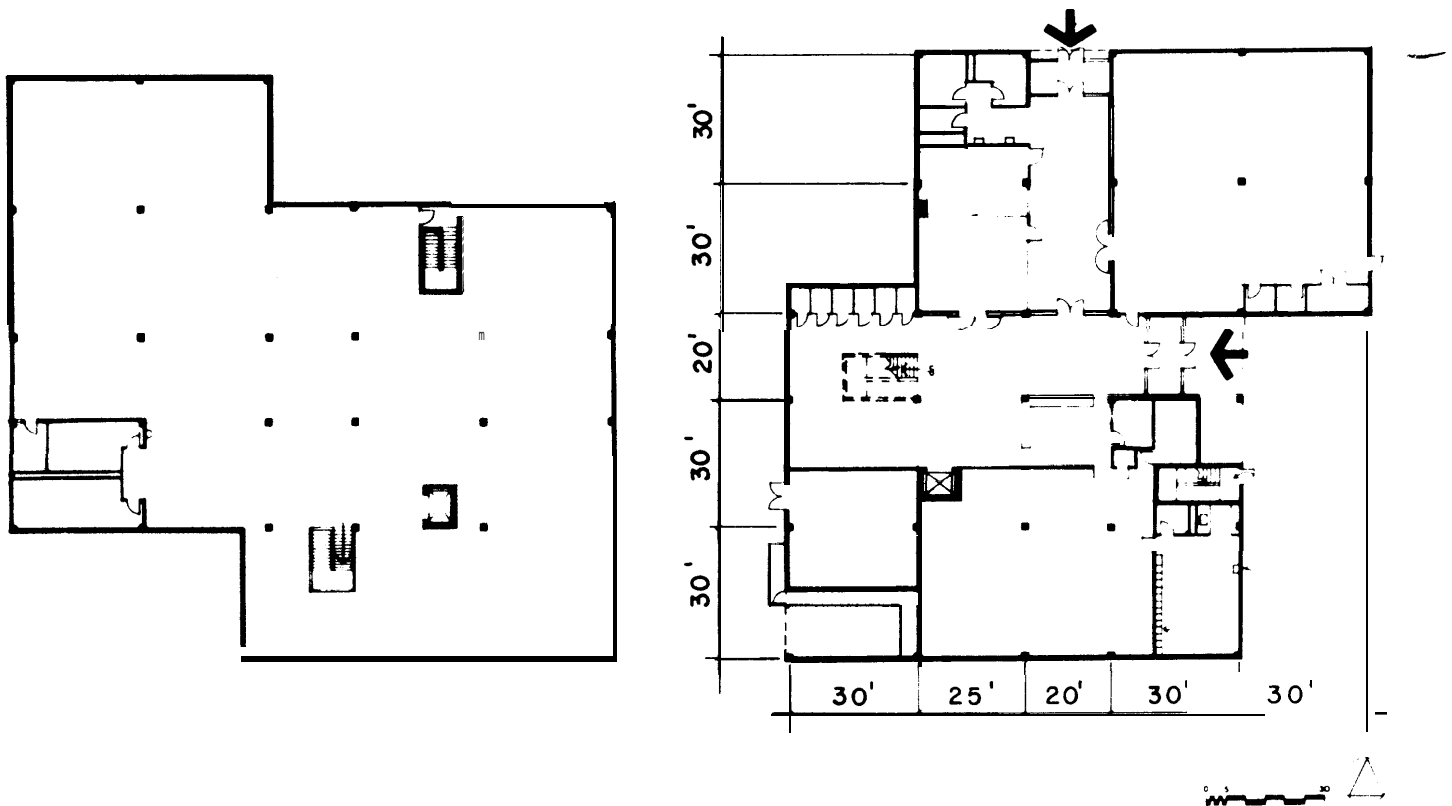

FIGURE 6-29

f. EXAMPLE DESIGN NO. 5, 30,000 GSF LIBRARY

(1) *Planning Data.* The military strength and total population at this post are presently the same as in example design No. 1; however, the post has been increasing its mission and strength for a number of years as a result of army consolidations and is expected to continue slow growth in the future.

(2) *Space Allocation.* The space allocation requirements in this example are the same as in example design No. 1, paragraph b(2) above.

(3) *Site Characteristics.*

(a) *Topography.* The library is located in an area designated as a community center on the master plan. The area is undergoing development from its previous function as a barracks area. The site is flat, but constricted by nearby buildings. Most of these buildings will be demolished as the community center is developed. This will take several years, by which time the library may require expansion.

(b) *Climate.* The post is located in the Midwest and has a temperate climate.

(4) *Functional Layout.* The building can be organized into the same functional grouping shown in Figure 6-24. All staff spaces can be grouped for maximum operational efficiency, and the general use areas can be grouped around the lobby for convenient control of after-hours utilization. Circulation must be provided from the lobby through the control area to the stack and reading areas. Acoustical privacy can be achieved by interposing

circulation and storage space between the functional groups and providing acoustical barriers where required.

(5) *Site Constraints.* The site constraints are similar to those of example design No. 4. A two-story inward-oriented facility is required, which will accommodate future expansion. To assure that expansion of library functions can occur simultaneously, spaces which are dedicated and unlikely to change should be clustered at the center of the building and spaces which are most likely to expand should be at the perimeter. This suggests a central lobby with adult and children's stacks, reading, and technical services areas against exterior walls. A scheme can be evolved such as shown in Figure 6-30. The upper floor should slightly overhang the ground floor to shield it from the high summer sun and expose it to the low winter sun.

(6) *Visual Control and Interest.* Visual control can be achieved by applying the principles expressed in design example No. 4. The building bulk and exterior exposure must be minimized, so a central courtyard is impractical. Visual interest can be supplied by means of a skylighted central gallery which acts as the main circulation space for both floors.

(7) *Modular Layout.* To assure future expansibility, a constant 30-foot by 35-foot structural grid can be used throughout the building, except for the 20-foot wide central gallery. Those functions which may operate during off-hours are grouped to permit separate zoning of heating and air conditioning. The toilets and other spaces requiring plumbing are clustered for economy.

FLOOR PLAN, EXAMPLE DESIGN NO. 5

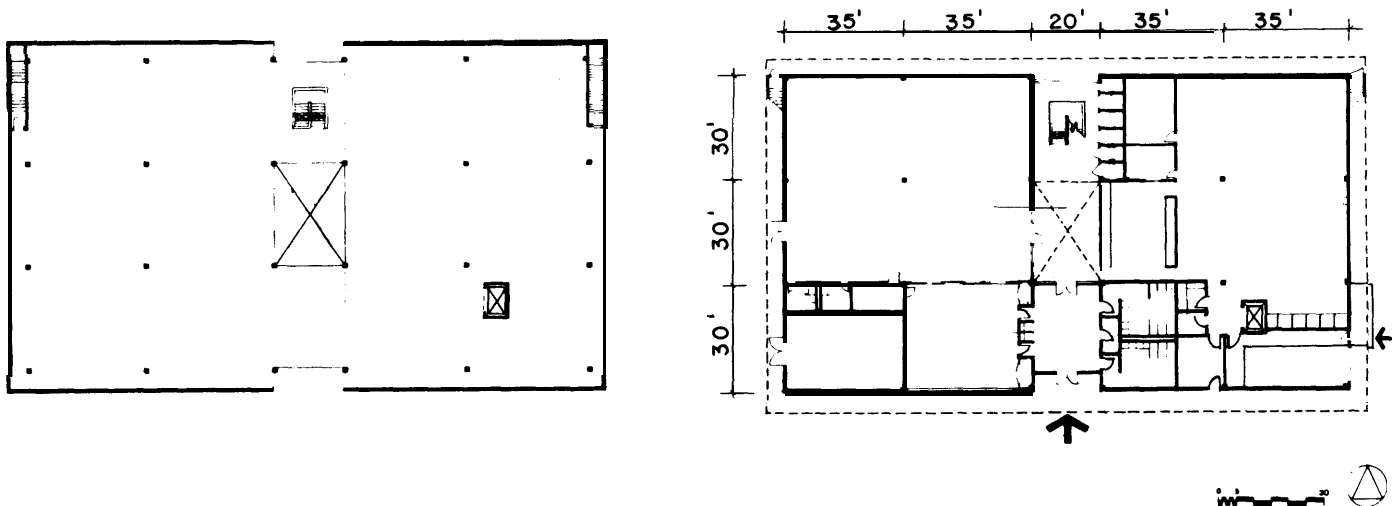

FIGURE 6-30

CHAPTER 7

Branch Libraries

7-1 GENERAL

a. REFERENCE

(1) AR 28-1 Army Recreation Services. The primary directive for Branch Post Libraries is contained in this document.

(2) DOD 4270.1-M Construction Criteria Manual states the following: When justified by the requirements of a particular installation, branch libraries, not exceeding 4,000 square feet in area, may be provided in support of an education center or for each increment of 3,000 military strength over 10,000. Where troop concentrations permit consolidation, the gross square foot area authorized for each increment of 3,000 military strength over 10,000 may be combined into one branch library. The space allowed for branch libraries is in addition to the space allowed for main libraries.

b. OBJECTIVES. The primary objectives of the branch library program are to promote use of information media for recreation, information, and education, and to support education and training programs. It provides all users with quiet, comfortable reading and study accommodations. It does not serve the entire post, rather only that geographical area in which it is located.

(1) The primary mission of the branch library will be leisure reading with a possible secondary role of supporting related educational functions.

(2) There will be no technical processing of library materials in the branch library. Technical processing will normally be accomplished at the main post library.

(3) Maximum support from the main post library through interlibrary loan and telephonic reference service is anticipated. This will result in less duplication in the collection and a smaller reference collection.

(4) Branch Library facilities will not generally be used after library hours.

7-2 PLANNING AND DESIGN CONSIDERATIONS

a. USERS. Participants are those primarily in the geographical area of the branch. The branch library will be located in a troop billeting area and will thus primarily serve enlisted personnel living in barracks on post. Or, it will be located adjacent to a post family housing area and will serve military personnel as well as military dependents, in which case space must be allocated for a children's area/reading room. The children's books, card catalog, and records and magazines will be located there. A branch library may be located to service the Army Continuing Education Services (ACES) Center.

b. THE BASIC AND AUXILIARY COLLECTIONS. The basic collection consists of nonfiction, fiction, and reference volumes. Auxiliary collections consist of the remainder of the materials listed in Table 7-1. The administrative librarian on the army post concerned should be required to provide detailed data to the engineer/architect regarding branch library collection requirements during the early planning stages. Table 7-1 shows the contents of a typical Branch Library Collection.

TABLE 7-1 TYPICAL COLLECTION FOR A 4,000 GSF BRANCH LIBRARY

Total Collection	6,000-8,000 volumes (minimum)
Nonfiction	3,600-4,800 volumes (60% of collection)
Fiction	2,400-3,200 volumes (40% of collection)
Reference	300-400 volumes (5% of collection incl. nonfiction)
Children's	600-800 volumes (10% of collection)*
Periodicals	50 titles (current subscriptions)
Newspapers	5 titles (local, major state, military branch, national, 41 daily, or weekly, post)
Maps	100 (road and some local topographic)
Records/Tapes	200 (no more than 10% may be children's)*
Paperbound (uncataloged)	250 titles

*May be omitted if branch library serves *only* a troop billeting area.

(1) *Reference Collection.* The major reference collection of the post will be at the main post library, not at a branch. The reference collection at the branch will, however, reflect the varying interests of activities and personnel served.

(2) *Microforms and Art Prints.* The branch library will be heavily supported by the main post library. It is not envisioned that the average branch library will house and provide microforms and art prints. Branch libraries larger than 4,000 GSF will generally include microform facilities, particularly if they support ACES programs.

(3) *Periodicals, Including Newspapers.* A limited number of periodicals and newspapers (refer to Table 7-1)

will be housed in the branch library. Patrons requiring materials not available at the branch library are referred to the larger, more extensive collection at the main post library.

(4) *Paperbacks*. Paperbound books will generally be shelved with the regular collection, or displayed in separate racks such as those found in bookstores.

(5) *Records and Tapes*. LP sound recordings will be shelved in a freestanding type carousel unit. Tapes will be stored in a counter top carousel unit.

(6) *Maps*. Maps will be stored in a vertical file.

c. **COMMUNITY PROGRAMS**. A branch would not have space for the conduct of meetings of any size. Primary consideration to be remembered with regard to the branch is that it would not be available for use during hours when the library is not open to the public.

d. **STAFF**. Three full time: one librarian at a desk, one library technician at a circulation desk, one library aide/clerk typist. No more than three staff members will be on duty at any given time. The Administrative Librarian will furnish design agency the local requirements for branch libraries at the time the design is being considered.

e. **TOTAL SPACE REQUIREMENTS**. Chapter 3 of DOD 4270.1-M, 3-8.18B sets forth space allowance criteria for Branch Libraries. Refer to paragraph 7-1.a(2). A majority of branch libraries will not exceed 4,000 GSF in size. Those branches containing additional square feet will generally include:

- Multi-purpose rooms
- Microform (primarily in support of education center programs)
- Larger book and periodical collections
- Additional space devoted to study/reading

7-3 INDIVIDUAL SPACE CRITERIA

Individual space criteria which are general to all library types is provided in Chapter 4. The criteria given below is intended to supplement Chapter 4 criteria with criteria specific to branch post libraries. All spaces normally included in branch libraries are listed below.

a. **ENTRANCE AND LOBBY**. The branch library should provide a minimal entrance/lobby area. It should consist of a vestibule of 100 NASF and a bookdrop area. The entrance/lobby should have adjacency to the control and circulation desk and the staff work area. It should be near the public toilets, children's area and listening room and it should be isolated from the stack area and the reading/study areas. For general criteria, refer to paragraph 4-1.

b. **PUBLIC TOILETS**. Public toilets are required for use of both public and staff during regular library hours. Separate facilities should be provided for men and women and should be adjacent to the entrance/lobby area and conve-

nient to the staff work area. The entrance to the toilets should be visible to the control and circulation desk if practicable. Refer to section 4-3d for fixture space requirements.

(1) *Space Requirements Table*. See Table 7-2.

TABLE 7-2 PUBLIC TOILETS SPACE REQUIREMENTS

Items	Unit Area Allowance	4000 GSF	
		QTY	NASF
Men			
WC (Handicapped)	42	1	42
Urinals	25	1	25
Lavatories	15	1	15
Women			
WC (Handicapped)	42	1	42
Lavatories	15	2	30
Total			154*

*Additional clearances required for handicapped circulation increases total space requirement to approximately 220 NASF.

(2) *Space Utilization Plan*. See Figure 7-1.

PUBLIC TOILETS SPACE UTILIZATION PLAN

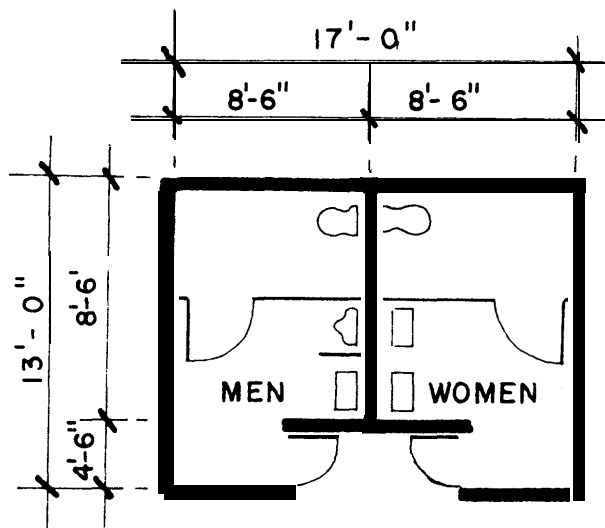

NOTE: PROVIDE CLEARANCES FOR HANDICAP USE

FIGURE 7-1

c. PUBLIC CARD CATALOG

(1) *General Criteria.* See paragraph 4-4.

(2) *Adjacencies.* The public card catalog, which is maintained by branch personnel, should be centrally located, adjacent to the control and circulation desk and the reference area and convenient to the entrance/lobby area.

(3) *Furniture and Equipment.* Card catalog, wood, 20 drawer. 26 inch table base with 15 drawer section, one 5 drawer section, one sliding shelf section, one top.

(4) *Space Requirements.* See Table 7-3

TABLE 7-3 PUBLIC CARD CATALOG

Items	Unit Area Allowance	4000 GSF QTY	NASF
Card Catalog	17	2	34

d. CONTROL AND CIRCULATION DESK AREA

(1) *General Criteria.* See paragraph 4-5

(2) *Adjacencies.* The control desk should be adjacent to the entrance so as to provide visual access to the public areas and to provide physical control of the entrance area. The card catalog should be no more than 15 feet away from the control desk. The print lease plan collection, if present, should be located within the control area.

(3) *Furniture and Equipment*

- Display case
- Bulletin board, wall mounted
- Circulation desk
- Chair, rotary without arms
- Tape audio displayer carousel, table top, free-standing
- Utility table
- Record display rack, carousel type, freestanding
- Paperback book rack, free-standing, revolving, capacity about 250 books
- Book display table, with cork display panel in center
- Book truck

(4) *Special Considerations.* The record display rack and the paperback book rack may be located in the card catalog area instead of the control and circulation desk area. The book display table may be located in a general reading area near the control area instead of in the control area if desired

(5) *Space Requirements.* See Table 7-4.

Table 7-4 Control and Circulation Desk Area Space Requirements

Items	Unit Area Allowance	4000 GSF QTY	NASF
Control Desk	120	1	120
Book Truck	12	1	12
Record Display Rack	10	1	10
Paperback Rack	10	1	10
Book Display	25	1	25
Display Case	18	1	18
Total			195

(6) *Space Utilization.* See Figure 7-2.

CONTROL DESK SPACE UTILIZATION PLAN

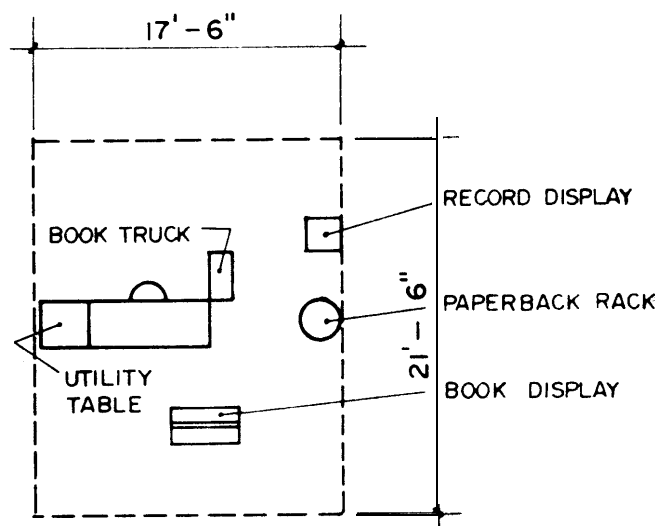

FIGURE 7-2

e. PERIODICALS/REFERENCE AREA

(1) *General Criteria.* See paragraphs 4-6, 4-7, and 4-8.

(2) *Adjacencies.* The reference portion of this area should be adjacent to the public card catalog. Also, since there is no reference librarian assigned to a branch library, the reference area needs adjacency to the control desk so that assigned personnel can handle reference questions. The periodicals area should also be adjacent to a reading/study area, and the microform area, if provided.

(3) *Furniture and Equipment.* Wall shelving for magazines, slanted shelves with storage for back issues underneath each shelf. At least three units. Newspaper rack with sticks, wall unit or table type. Capacity, ten newspapers. Current issues only will be available with the exception of the *Army Times* which will be retained for six months.

Atlas stand.

File cabinet, legal size, four drawer. Known as "vertical file" for maps and pamphlets. Maps will be limited to local, state, and national road and topographical maps which can be stored in the vertical file.

Bookshelves, wall type: four units with three shelves/unit. Dictionary stand, revolving single face; sits on table. Seating: one reading table with four chairs, lounge chairs, (as space allows).

(4) *Special Considerations.* Microform materials or equipment will normally not be a part of the branch library collection. However, adequate electrical outlets should be installed in the reading areas and multi-purpose room to service microform equipment if added. See paragraph 4-8.

(5) *Space Requirements.* See Table 7-5.

TABLE 7-5 PERIODICALS/REFERENCE AREA SPACE REQUIREMENTS

Items	Unit Area Allowance	4000 GSF	
		QTY	NASF
Shelving-Reference	9	4	36
Shelving-Periodical	14.5	3	44
Newspaper Rack	17	1	17
Atlas Stand	25	1	25
Dictionary Stand	25	1	25
Legal File	10	1	10
Lounge Seating	30	2	60
Table Seating	25	4	100
Total			317

(6) *Space Utilization Plan.* See Figure 7-3

PERIODICALS AREA SPACE UTILIZATION PLAN

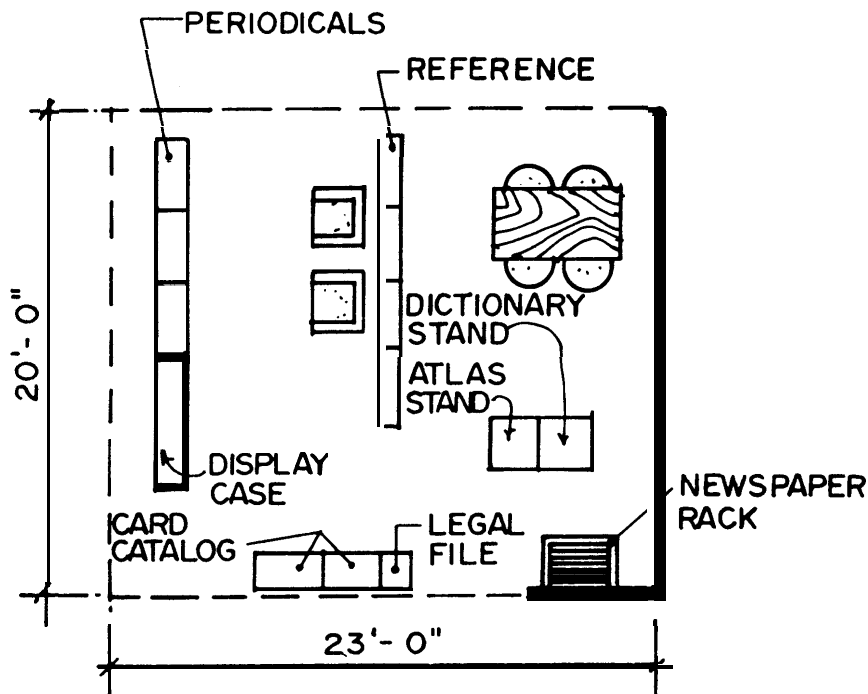

FIGURE 7-3

f. CHILDREN'S AREA

(1) *General Criteria.* See paragraph 4-14. The children's area, if provided in the branch library, would not be provided with a children's librarian nor would separate children's toilets be provided.

(2) *Adjacencies.* The children's area needs to have adjacency to the control and circulation desk for supervisory purposes. It should be isolated from the main reading/study areas of the library.

(3) *Furniture and Equipment.* Bookshelves, wall type: Provide 10 units with three shelves per unit. Card catalog, four drawer: with table base approximately 37 inches high.

Table Seating, double slope shelf.

- Benches: two
- Cushions
- Chairs

(4) *Special Considerations.*

(a) Instead of providing a children's area, a children's room of at least 286 square feet may be provided. Combining this with the music reading special activities room would be acceptable. Separate entrances to each part of the room from the interior of the library would be necessary.

(b) The example branch library layout provided here includes a children's area. Where the library serves only a troop area, not requiring a children's room, this space is normally used for seating and stacks.

(5) *Space Requirements.* The branch library size is based upon troop population but there are no standards for size of a children's area (See Table 7-6.)

CHILDREN'S AREA SPACE UTILIZATION PLAN

OUT DOOR READING AREA

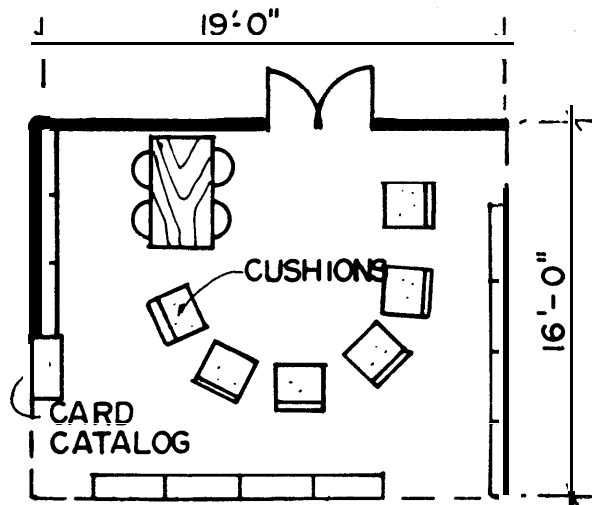

FIGURE 7-4

TABLE 7-6 CHILDREN'S AREA SPACE REQUIREMENTS

Items	Unit Area Allowance	4000 GSF	
		QTY	NASF
Shelving	9	10	99
Card Catalog	17	1	17
Table Seating	20	4	80
Cushions	15	6	90
Total			286

(6) *Space Utilization Plan.* See Figure 7-4.

q. STACK AREA

(1) *General Criteria.* See paragraph 4-9.

(2) *Adjacencies.* This area should be adjacent to the reading/study areas and isolated from the entrance and lobby.

(3) *Furniture and Equipment.* Stack shelving should be free-standing, double faced type. Refer to Table 3-2 in Chapter 3 for shelf capacity based on various book types in library collection.

(4) *Paperbound Books.* Paperbound books will generally be shelved with the regular collection although libraries may utilize display racks such as those found in bookstores for uncataloged paperbound books.

(5) *Space Requirements.* See Table 7-7.

TABLE 7-7 STACK AREA SPACE REQUIREMENTS

Items	Unit Area Allowance	4000 GSF	
		QTY	NASF
Shelving/Nonfiction	9	47	423
Shelving/Fiction	9	30	270
Total			693

(6) *Space Utilization Plan.* See Figure 7-5.

STACK AREA SPACE UTILIZATION PLAN

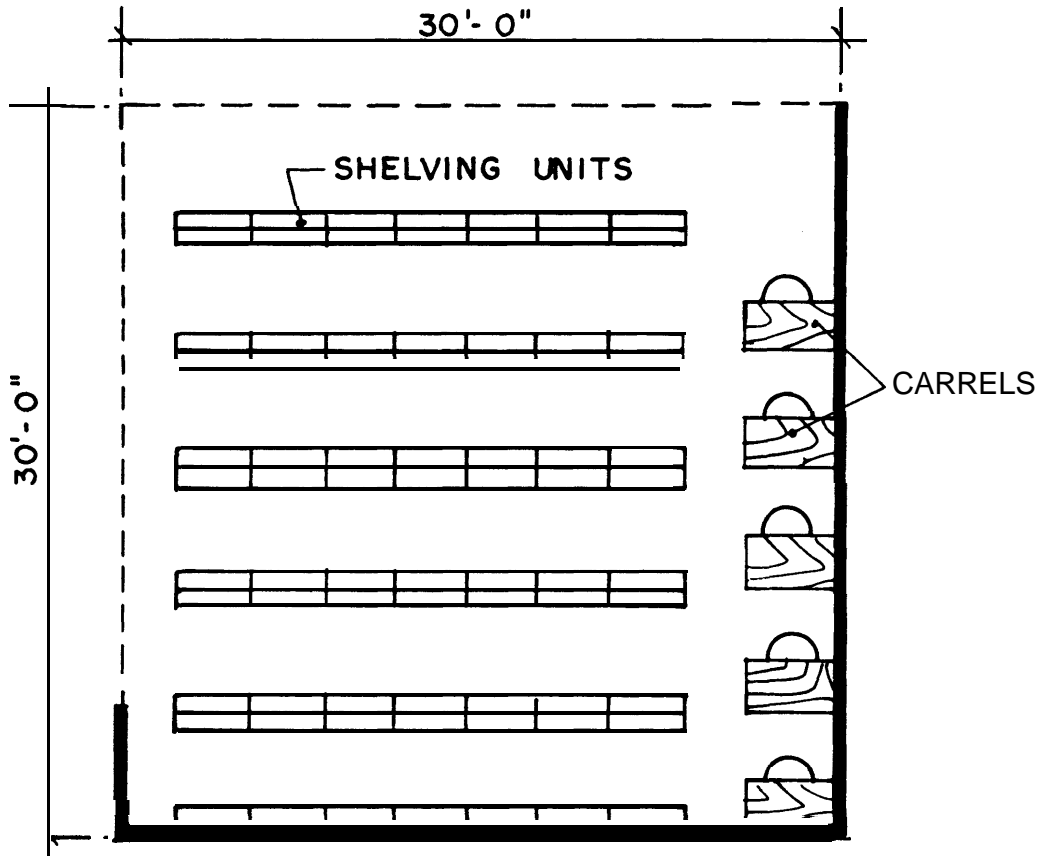

FIGURE 7-5

h. READING/STUDY AREA

(1) *General Criteria.* See paragraph 4-10.

(2) *Adjacencies.* This area should be adjacent to the reference area and to stack area and isolated from the entrance and lobby, children's area, and the reading/listening room.

(3) *Furniture and Equipment.* Carrels, study single. Lounge chairs: as permitted by space.

(4) *Space Requirements.* See Table 7-8.

TABLE 7-8 READING/STUDY AREA SPACE REQUIREMENTS

Items	Unit Area Allowance	4000 GSF	
		QTY	NASF
Carrels	30/seat	9	270
Lounge Seating	30/seat	12	260
Side Tables	10	2	20
Total			650

(5) *Space Utilization Plan.* See Figure 7-6.

READING/STUDY AREA SPACE UTILIZATION PLAN

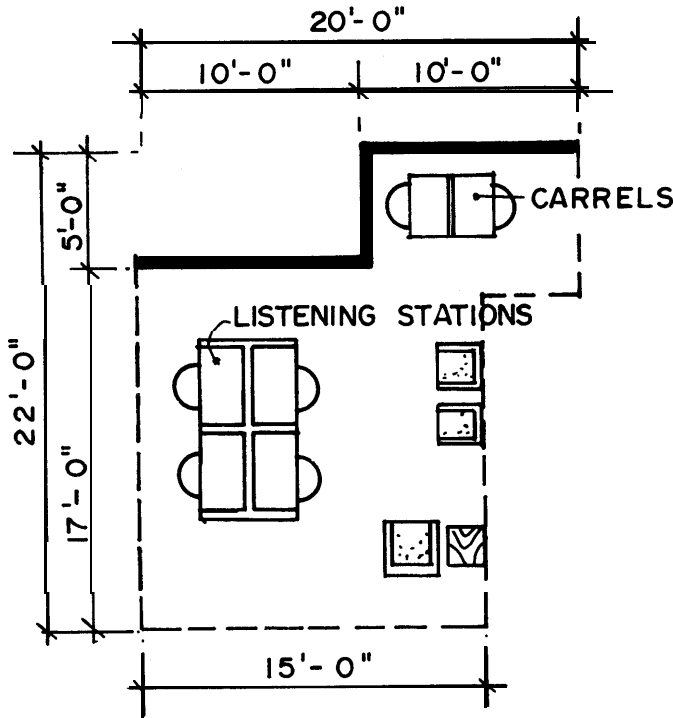

FIGURE 7-6

TABLE 7-9 READING/LISTENING ROOM SPACE REQUIREMENTS

Items	Unit Area Allowance	4000 GSF QTY	NASF
Carrels	30/seats	2	60
Lounge Seating	30/seats	3	90
Table	10/seats	1	10
Listening Stations	30/seats	4	120
Total			280

(6) Space Utilization Plan. See Figure 7-7.

READING/LISTENING AREA SPACE UTILIZATION PLAN

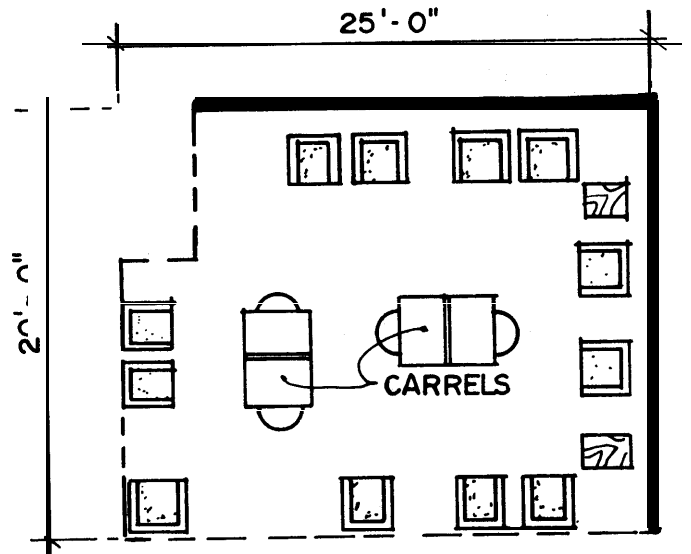

FIGURE 7-7

i. READING/LISTENING ROOM (Multi-Purpose)

(1) *General Criteria.* Refer to study rooms criteria, paragraph 4-11 and multi-purpose room criteria, paragraph 4-2.

(2) *Adjacencies.* This area should be isolated from public toilets, stack areas, and the janitor's closet.

(3) *Furniture and Equipment*

- Carrels, modular
- Lounge Chairs: as permitted by space
- Table, lounge coffee type
- Record listening stations

(4) *Special Considerations.* Record listening stations should be in the form of movable turntables with amplifiers located on tables on/in carrels (dry) in the reading/listening room. Listening will be by use of earphones. Adequate numbers of electrical outlets should be provided in the room.

(5) *Space Requirements.* See Table 7-9.

j. STORAGE ROOM

(1) *General Criteria.* A locked storage room is needed. Floor space should be 180 to 250 NASF. Stackable chairs, display materials, and equipment (i.e., record players, projection screen, etc.) will be stored there.

- (2) *Adjacencies.* Adjacent to work area.
- (3) *Furniture and Equipment*
Shelves, wall, seven shelves per unit.
Chairs, stack: store approximately 20.

k. STAFF WORK AREA

- (1) *General Criteria.* See paragraph 4-16, Technical Services.
- (2) *Activities.*
 - (a) Typing of correspondence and replacement of book cards and overdues.
 - (b) Storage of books to be shelved on book trucks.
 - (c) Shelving of transient materials: new books incoming from the library service center, interlibrary loans from the main post library, books being returned to the main post library.
 - (d) Storage of frequently used materials or reserve materials for which there is no room under the circulation desk.
 - (e) Storage of frequently used equipment: record players, cassette players, etc.
 - (f) Staff support activities.
 - (g) Limited processing (stamping, hanging, etc.) of magazines and newspapers.
 - (h) Preparation of display materials.
 - (i) Limited storage of back issues of magazines.

(3) *Adjacencies.* This area should be adjacent to the entrance and lobby, control and circulation area, and to the storage room and located behind the control/circulation desk.

(4) *Furniture and Equipment*

- Free-standing shelving, single faced.
- Desk and chair with 4 drawer legal file
- Work table and chairs
- Counter height bookshelf, single faced
- Lockers
- Book trucks
- Lounge furniture consisting of lounge chairs, lounge table
- Double faced mobile shelf unit
- Coat Rack

(5) *Special Considerations.* Library materials should arrive at the branch library ready to be shelved. Catalog cards will be filed by branch library personnel. The shelf list will be maintained at the central processing center.

(6) *Space Requirements.* See Table 7-10.

TABLE 7-10 STAFF WORK AREA SPACE REQUIREMENTS

Items	Unit Area Allowance	4000 GSF	
		QTY	NASF
Shelving (full ht)	9	3	27
Shelving (counter ht)	9	1	9
Mobile Shelving	12	1	12
Book Truck	12	3	36
Desk and Chair	50	1	50
File Cabinet	10	1	10
Work Table and Chairs	60	1	60
Lounge Seating	30	3	90
Lounge Table	20	1	20
Lockers	4	3	12
Coat Rack	4	1	4
Total			330

(7) *Space Utilization Plan.* See Figure 7-8.

STAFF AREA SPACE UTILIZATION PLAN

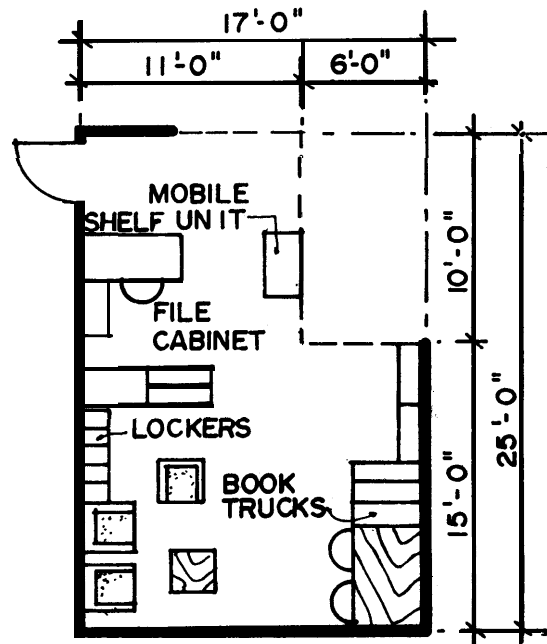

FIGURE 7-8

l. JANITOR'S CLOSET. A janitor's closet should be located adjacent to the staff work area and in close proximity to the public toilets if possible. Space requirements are as provided by janitor's closet criteria in paragraph 4-19.

m. SUMMARY. Table 7-11 provides a summary of the space requirements for a branch library and Table 7-12 contains the adjacency relationships. Figures 7-9 and 7-10 illustrate examples of plan layout and a site plan layout.

TABLE 7-11 BRANCH LIBRARY SUMMARY OF SPACE REQUIREMENTS

Space	NASF	Comments
a. Entrance and Lobby	100	
b. Public Toilets	200	
c. Public Card Catalog	34	
d. Control and Circulation Desk	195	
e. Periodicals/Reference Area	317	
f. Children's Area	286	
g. Stack Area	693	
h. Reading/Study Area	650	
i. Reading/Listening Room	280	
j. Storage Room	250	
k. Staff Work Area	330	
l. Janitor's Closet	55	
Total NASF	3390	
Core Area 15% + SF	510	
GSF	3900	
Mechanical Equipment Room	425	
Total Requirement	4325	

TABLE 7-12 BRANCH LIBRARY ADJACENCY RELATIONSHIPS

SPACE	Adjacent	Near 25	Near 75	Isolated
1. Entrance and Lobby	3,12	2,7,10	13	9,8
2. Public Toilets	13	1,3,14	7,10	
3. Control and Circulation Desk	1,4,12	2,5,6,7,10,11	8,13	
4. Public Card Catalog	3,5	7,8,9,12	1,4	
5. Reference Area	4,6,9	3,8	1,13	
6. Periodicals Area	5	3,8,9	1,10,13	
7. Children's Area		1,3,4,10	2,13	9
8. Stack Area	9	5,6	3,4,14	1
9. Reading/Study Area	5,8	4	3,6,13,11	1,7,10
10. Reading/Listening Room		1,3,11	2,7	2,7,13
11. Storage Room	13	3	7,9	
12. Work Area	1, 3, 11	4	13	
13. Janitor's Closet		(All near 75 to other areas)		
14. Microform Area	6	3		
15. Multi-purpose Room		1,3		2,4,7

EXAMPLE PLAN LAYOUT, BRANCH LIBRARY

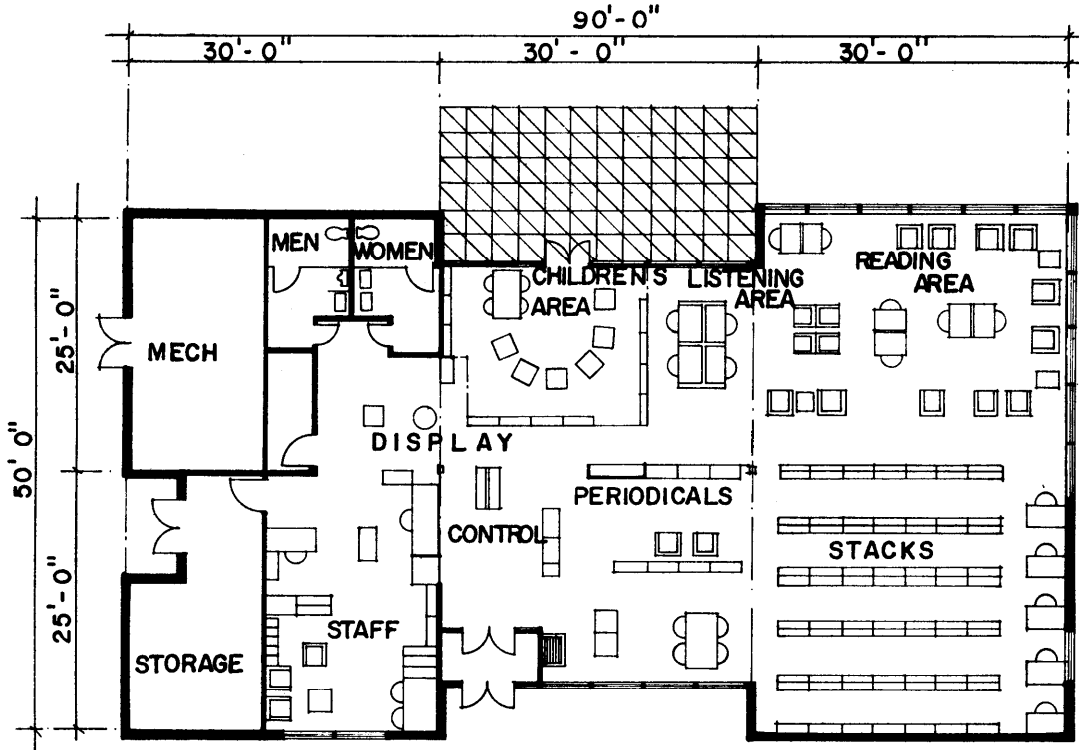

FIGURE 7-9

EXAMPLE SITE PLAN LAYOUT, BRANCH LIBRARY

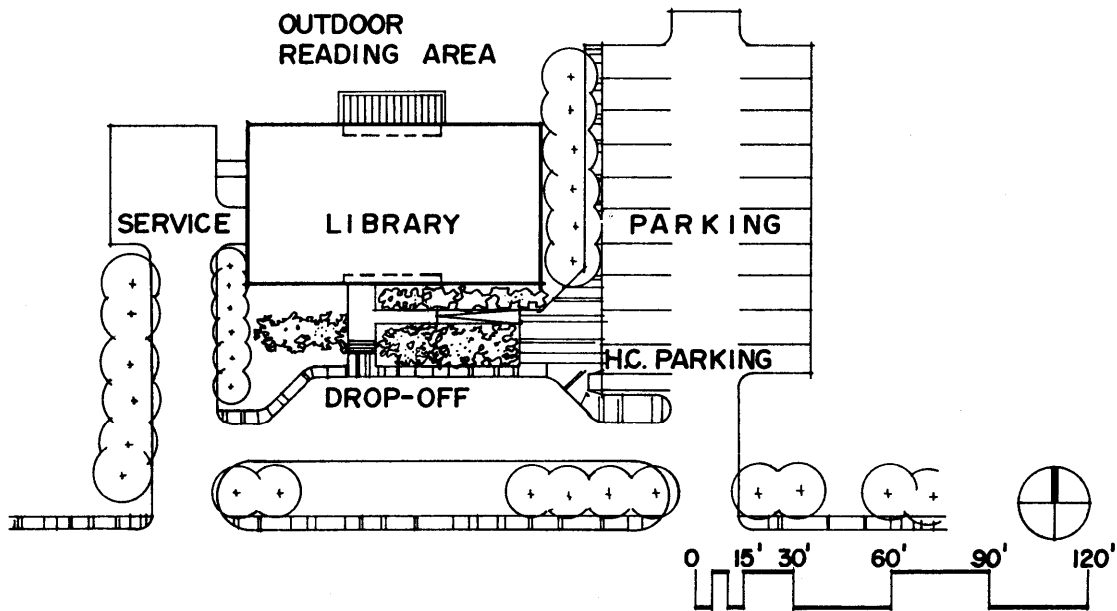

FIGURE 7-10

CHAPTER 8

Scientific and Technical Information Centers/ Libraries

8-1 GENERAL

This chapter discusses libraries supporting scientific research or providing specialized technical information.

a. REFERENCES

(1) AR 70-45 Scientific and Technical Information Program

(2) DOD Directive 5100.36 Department of Defense Technical Information.

b. OBJECTIVES OF SCIENTIFIC AND TECHNICAL INFORMATION CENTERS/LIBRARIES. The term "scientific and technical information centers/libraries" applies to the following library types:

(1) A technical library is considered a service activity that selects, acquires, and organizes documents for retrieval to support the scientific and technical efforts of the parent organization. Services may include, but are not limited to, preparing and publishing accession lists, indexes, abstracts, and bibliographies.

(2) A technical information center is defined as an organization concerned with receiving, processing, and distributing technical information to internal and external users. A center's functions may include, but are not necessarily limited to, report preparation services, primary production and distribution, technical editing, graphic arts, still and motion photography, and to technical library and information analysis center activities.

c. FUNCTIONS OF SCIENTIFIC AND TECHNICAL INFORMATION CENTERS/LIBRARIES. Although scientific and technical information centers/libraries perform the same basic functions as other libraries, there is a unique and more in-depth level of service and dissemination which is performed by scientific and technical information centers/libraries. Generally they offer highly specialized and personalized services for the user population; provide quick access to and/or retrieval of information for the user population due to the immediacy of information needs; are unique in that their collections are topical and information retrieval to set up with primary responsibility and first priority to the mission and/or users who serve this mission; and make intensive use of interlibrary loans to supplement the basic collection.

8-2 PLANNING AND DESIGN CONSIDERATIONS

a. LIBRARY USERS. As distinct from a general library, a

scientific and technical information center/library's primary responsibility is to serve a particular mission(s) and first priority is therefore given to personnel assigned to carrying out this mission(s). Users consist of scientists, technicians, and professional staff engaged in scientific and technical work. Civilians, contractors, and other off-post persons may also be included in the user population, although borrowing privileges will be determined by the responsible agency. Scientific and technical information center/library users require more bibliographic search and make more telephone inquiries and requests for information than do users of general libraries. In any research and development environment, scientific and technical information is a commodity with a dollar value relative to its timely availability. Consequently, current and pertinent information is a critical commodity which must be made accessible to decision makers to meet their basic information needs in various management and technical operational areas.

b. STAFF. Scientific and technical information center/library staff requirements are based on size and type of user population, kind and type of services required, and the mission(s)/function(s) assigned to the library. The staffing requirements shown in Table 8-1 have been developed based on a 21,250 GSF technical information center with an active user population of 500. Staffing requirements for individual libraries should be developed by the administrative librarian and forwarded to the design agency.

TABLE 8-1 EXAMPLE STAFFING

Technical Information Center		21,250 GSF	
<u>Professionals</u>		<u>Non-Professionals</u>	
Administrative Librarian	1	Administrative Secretary	1
Supervisory librarian	1	Clerk-Typist	3
Abstractor	1	Technical Services Technician	3
Technical Services Librarian	1	Control Desk Technician	5
Cataloger	1	Warehouseman	1
Reference Librarian	3	Technical Publications Writer/Editor	1
Information Specialist	1		
Translator	1		
Total	10	Total	14

c. COLLECTION. The scientific and technical information center/library collection makes less use of book materials, with the exception of standard technical reference books, than a general post library. Composition of the collection has more emphasis on bound and unbound periodicals, technical reports, and microform materials.

This is primarily due to the "immediacy" requirement of scientific and technical work. A high percentage of materials on microform is a result of limited storage area, quick transfer of information, and general economy. Those libraries which serve a central or regional function in an overall system of libraries often have higher percentages of book materials and historic documents as related to the overall collection than do those libraries which perform single missions. Table 8-2 illustrates the composition of a hypothetical collection for a 21,250 GSF technical information center. Collection requirements for individual projects should be developed by the administrative librarian in conjunction with the mission organization and furnished to the design agency.

**TABLE 8-2 EXAMPLE COMPOSITION
OF COLLECTION**

Technical Information Center		21,250 GSF
Type	No. of Items	
Books	16,000	
Bound Periodicals	30,000	
Technical Reports	36,000	8,000 classified
Serials (newspapers, magazines, etc.)	1,000	
Microfilm		
16 mm	32,000	3,200 classified
35 mm	4,000	400 classified
Microfiche	260,000	
Total Collection	379,000	

d. LOCATION. Because the function of the scientific and technical information center/library is to provide services for a particular technical mission, the technical library is often located in a building to be occupied by the mission organization. The library should be easily accessible from the main entrance of the building, consolidated into one area of the building, and be convenient for heavy users of the collection. As technological innovations (individual mini-computers, etc.) are incorporated into the library function, the need for close proximity to the mission organization may become less acute.

e. MAXIMUM SPACE REQUIREMENTS. There are no official maximum space allowances which have been established for scientific and technical information centers/libraries.

f. ACTUAL SPACE REQUIREMENTS. A general method of determining actual space required has been presented in Chapter 2. However, care must be exercised to assure that this method has application to a given project. Scien-

tific and technical information centers/libraries vary widely in size, staff, services provided, and in the relationships among these with collection size, user seating, staff space, etc.

(1) *Space Requirements-Collection.* The number of units required for storage of the scientific and technical information center/library collection can be computed by dividing the number of projected items of the collection by the number of items per storage unit shown in Table 3-2. The number of storage units thus derived is then multiplied by the net assignable square feet (NASF/unit) to determine the actual space requirements for each type of material. Generally, the space requirement for the collection is about 50 percent of the total library NASF.

(2) *Space Requirements-Reader Stations.* Scientific and technical information center/library users require less seating in the library and require a different kind of seating than users in general libraries. The number of users/day who come to the library is relatively small. This is partially due to the level of service provided in technical libraries and the percentage of user requests that are made by telephone. As technology permits more use of such equipment as mini-computers located at the scientists' desk for information access, the library will become more and more of a service center with even less requirement for user seating. General reading areas have less value in the technical library. Rather, a combination of private study-conference areas, carrels, and table seating should be provided. Researchers need to gather references, discuss with co-workers, and have available a typewriter for making notes and recording results. Research sometimes requires days, and a user should be able to lock his compartment and return to it for further study. The numbers of seats and seating types should be determined in accordance with Paragraph 2-4c on the basis of work tasks which will be performed by users. Space requirements for each reader station also will be in accordance with Paragraph 2-4c.

(3) *Space Requirements-Staff Area and Work Stations.* Staff space is highly dependent upon the level of service which will be offered by the scientific and technical information center/library. Administrative, reference, and information specialist staff members should be provided with private offices in most cases due to the nature of the functions which they perform. Technical services staff should be located in a separate and private area. The amount of space allocated for technical service functions will be dependent upon: the type of cataloging process (manual or computer); the form of new materials acquired for cataloging (books, journals, microform, etc.); the amount of binding of periodical literature; and the intensity of interlibrary loan usage.

g. PARKING. Since many science and technical information centers/libraries are incorporated as part of exist-

ing or new space in a building and serving a particular mission which is generally located within the same structure, parking requirements must be determined on an individual basis by the administrative librarian and furnished to the design agency.

h. **TECHNOLOGICAL CONSIDERATIONS.** A number of technological innovations are available now and for planning purposes, other possible Information system breakthroughs will be available in the foreseeable future, which must be considered in the planning and design of the scientific and technical information centers/libraries. introduction of this technology into the library can greatly affect: staff requirements by type; amount of user space provided; type of collection storage; and type of technical services necessary. Overall library space requirements probably will not be affected by this technology rather the internal organization and allocation of space to various functions will change. Paragraph 2-9 presents a summary of the "state-of-the-art" of various technological considerations. Dependent upon the individual library's mission and the availability of technology, the administrative librarian and the mission organization must mutually decide what kind of technology will be utilized in the library and furnished this information to the design agency. It is important that this be determined in the early stage of the design process since the kind of technology used can greatly affect space allocation, function, and the basic mechanical-electrical requirements for the building.

8-3 INDIVIDUAL SPACE CRITERIA

Individual space criteria which is considered general to all library types has been provided in Chapter 4. The criteria given below is intended to supplement the information in Chapter 4 by developing for a hypothetical scientific and technical information center/library of 21,250 GSF.

a. **ENTRANCE AND LOBBY** Size of entrance and/or lobby area in the scientific and technical information center/library varies dependent upon the size of the facility location of the library in an independent structure, or included as space within an existing or new building. In each case, the entrance/lobby area should be adjacent to the control area and the card catalog area. The required area will depend on the number and kind of spaces which open onto the lobby, and the anticipated traffic flow.

(1) *Space Requirements.* See Table 8-3

TABLE 8-3 ENTRANCE AND LOBBY SPACE REQUIREMENTS

Item	Unit Area Allowance	Example Requirements	
		QTY	NASF
Lounge Chairs	30	3	90
Vestibule	100	1	100
Display Cabinets	25	1	25
Table	20	1	20
Total			235

(2) *Space Utilization Plan.* See Figure 8-1

ENTRANCE AND LOBBY SPACE UTILIZATION PLAN

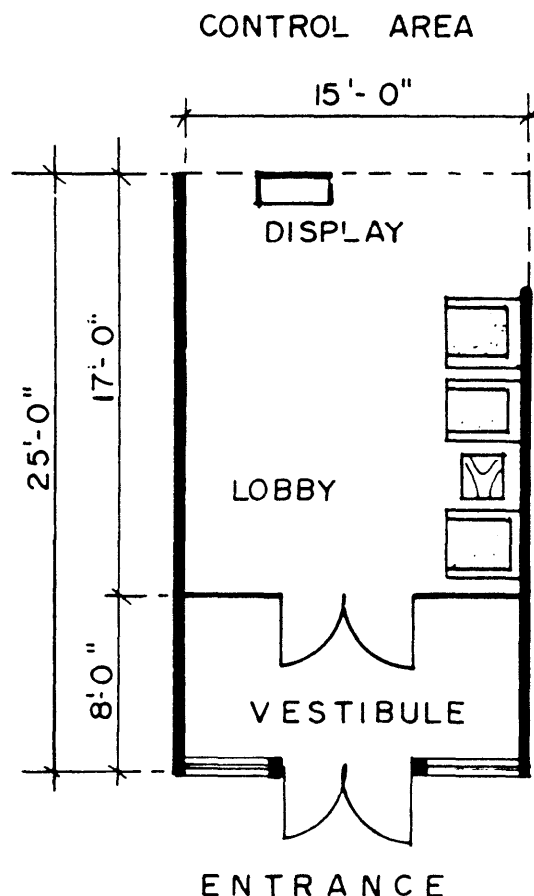

FIGURE 8-1

b. PUBLIC TOILETS. Since most scientific and technical information facilities are located in existing or new space in conjunction with primary mission functions, public toilets are often not included for the exclusive use of users and staff. Where this is the case, it is important that library space be located in close proximity to toilet facilities. Where the library is either located in separate space or of such a size to warrant providing its own toilet facility, Table

8-4 should be utilized to determine number of fixtures and space requirements for toilets areas in accordance with fixture allowances given in Table 10-7 of DOD 4270.1-M. Number of people indicated should be based on number of seats provided plus full time staff if separate staff toilets are not provided. Percentages of men and women users and staff must be determined in order to make proper allocation of space between mens' and womens' toilets.

(1) *Space Requirements.* See Table 8-4.

**TABLE 84. PUBLIC TOILET SPACE REQUIREMENTS—(HYPOTHETICAL EXAMPLE)
(21,250 GSF)**

Items	Typical Occupancy Unit Area Allowance	30 Men 30 Women		50 Men 50 Women		90 Men 90 Women		150 Men 150 Women		
		QTY	NASF	QTY	NASF	QTY	NASF	QTY	NASF	
Men										
WC (regular)	25	1	25	2	50	4	100	5	125	
Urinals	25	1	25	2	50	3	75	3	75	
Lavatories	15	2	30	3	45	5	75	6	90	
WC (handicapped)	42	1	42	1	42	1	42	1	42	
Women										
WC	25	1	25	3	75	5	125	5	125	
Lavatories	15	2	50	4	60	6	90	6	90	
WC (handicapped)	42	1	42	1	42	1	42	1	42	
Total			239		364		549		589	

(2) *Space Utilization Plan.* See Figure 8-2.

PUBLIC TOILETS SPACE UTILIZATION PLAN

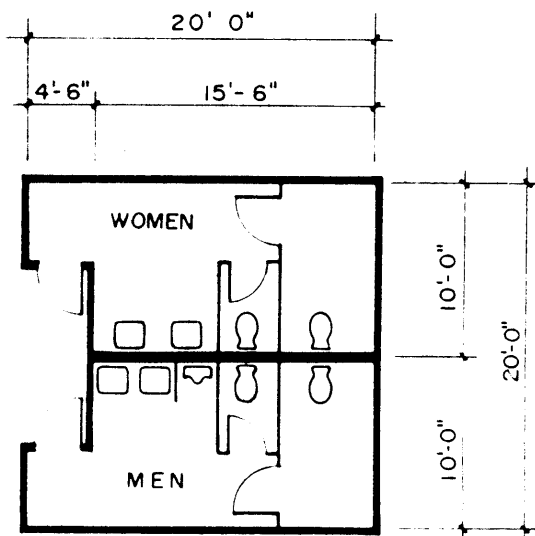

FIGURE 8-2

c. CARD CATALOG AREA. The card catalog area is used by both library users and staff to locate materials and is maintained by the technical services personnel. In scientific and technical information centers/libraries, the standard card catalog may be used in a variety of ways alone; or in combination with other cataloging formats such as microfiche or book catalogs. Because technical library collections are composed of high percentages of periodical and technical report information with expanding use of microform, the standard card catalog may be replaced wholly or in part by other cataloging formats. The card catalog area should be centrally located adjacent to and visible from the entrance, control, and reference areas. It should be easily accessible from the technical services area, the book stacks, and the periodical area.

(1) *Space Requirements.* See Table 8-5

TABLE 8-5 CARD CATALOG AREA SPACE REQUIREMENTS

Item	Unit Area Allowance	Example Requirements	
		QTY	NASF
Card tray unit	17	12	204
Reference Table (4 stations w/stools)	96	1	96
Total			300

(2) Space Utilization Plan. See Figure 8-3.

TABLE 8-6 CONTROL AREA SPACE REQUIREMENTS

Item	Unit Area Allowance	Example Requirements	
		QTY	NASF
Work Station	80	4	320
Control Desk	80	1	80
Files	10	4	40
Copy Machine	60	1	60
Total			500

(2) Space Utilization Plan. See Figure 8-4.

CARD CATALOG SPACE UTILIZATION PLAN

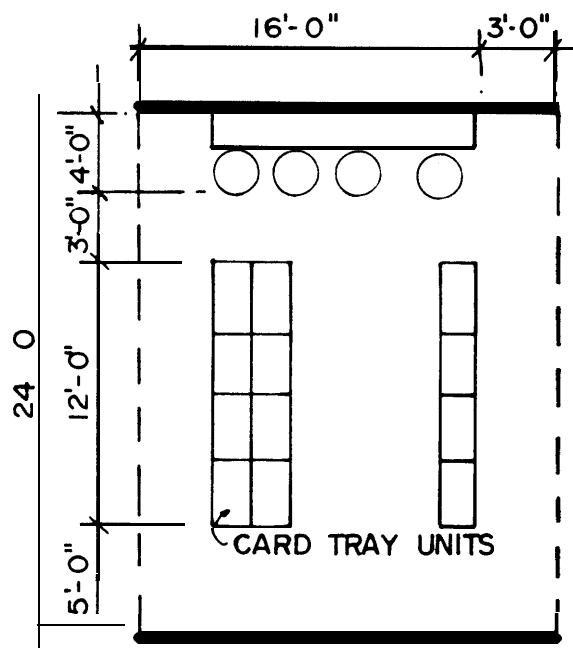

FIGURE 8-3

CONTROL AREA SPACE UTILIZATION PLAN

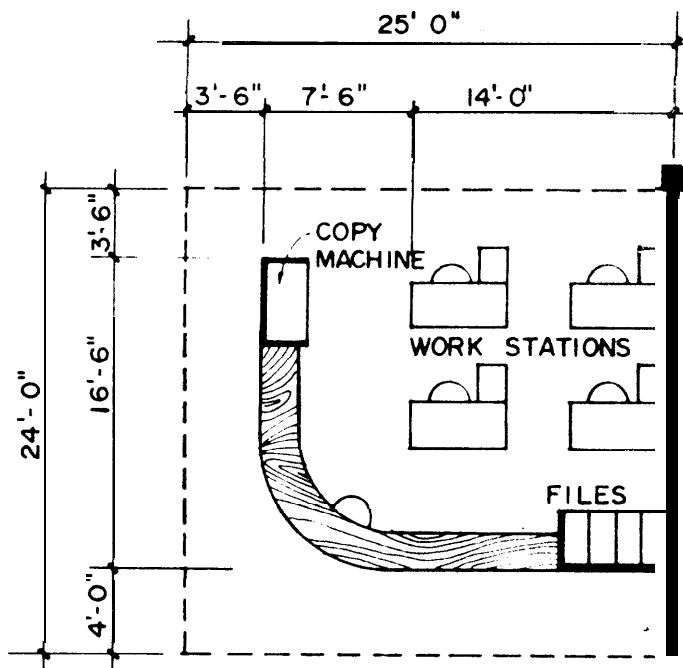

FIGURE 8-4

d. CONTROL AREA. The control area should be located adjacent to the entrance/lobby and card catalog area but removed from reading and study areas in order to minimize distractions. The control area has responsibility for circulation and inter-library loan and for the 21,250 GSF technical information center. It is staffed by five control desk technicians.

(1) Space Requirements. See Table 8-6.

e. PERIODICAL AREA. The periodical area should be located in proximity to the entrance/lobby and control area. Current periodicals including technical journals, magazines, and newspapers are stored here usually in display shelving. Shelving should be provided for current issues plus one year of back issues. Table seating and/or lounge seating should be provided in this area.

(1) Space Requirements. See Table 8-7.

TABLE 8-7 PERIODICAL AREA SPACE REQUIREMENTS

Item	Unit Area Allowance	Example Requirements	
		QTY	NASF
Display Shelving*	13½	56	756
Newspaper Rack	17	1	17
Lounge Seating	30	8	240
Total			1013

*Based on 960 serials at 15 serials/unit

(2) *Space Utilization Plan.* See Figure 8-5.

PERIODICALS AREA SPACE UTILIZATION PLAN

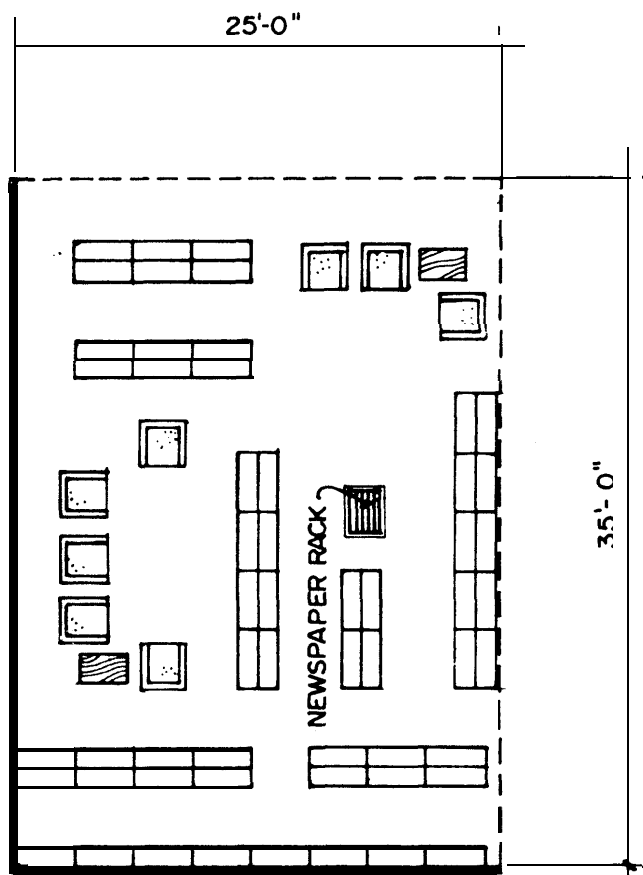

FIGURE 8-5

f. **REFERENCE AREA,** The reference area should be in close proximity to the card catalog area, microform area, and technical report section of the book stack. The reference area should house technical reference books, abstracts, and part of the technical report collection. In addition, standard reference materials such as atlases, maps, and dictionaries are also located in this area. The reference librarian should have a private office with enough space for meetings with 2 to 4 people. The reference librarian performs research and editorial functions and often has to meet with users to discuss particular research problems and needs. Provision of a computer terminal in this area for bibliographic search may be necessary.

The 21,500 GSF technical information center will make provisions for three reference librarians and one abstractor. Two of the reference librarians should be provided with private offices whereas the third should be provided with a visible work station in the reference area. The abstractor should be located within 25 feet of the stacks.

(1) *Space Requirements.* See Table 8-8.

TABLE 8-8 REFERENCE AREA SPACE REQUIREMENTS

Item	Unit Area Allowance	Example Requirements	
		QTY	NASF
Shelving (2000 vols)	9	24	216
Map Case	40	1	40
Atlas Case	15	1	15
Dictionary Stand	15	1	15
Lat. Files	12	94	1128
Reference Librarian	150	2	300
Reference Librarian	100	1	100
Abstractor	100	1	100
Table Seating	25	12	300
Index Tables	25	4	100
Total			2314

(2) *Space Utilization Plan.* See Figure 8-6.

REFERENCE AREA SPACE UTILIZATION PLAN

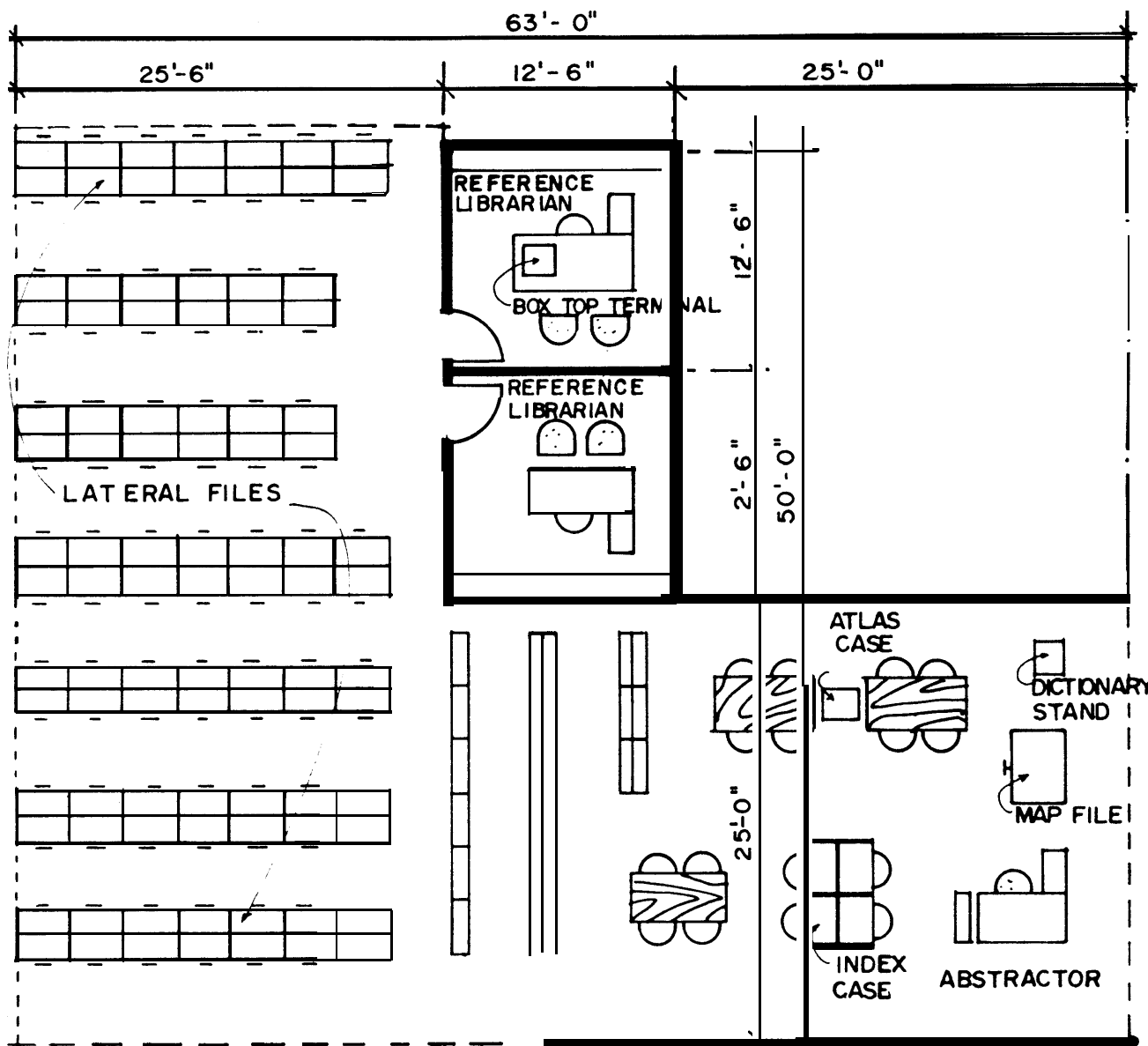

FIGURE 8-6

**CHAPTER 8: SCIENTIFIC AND TECHNICAL INFORMATION
CENTERS/LIBRARIES**

FEBRUARY 1983

g. STACK AREA. The card catalog area and reference area should have proximity to the stack area. Technical services should be located nearby. Stack areas should be close to and interspersed with table and/or carrel seating. Individual study areas (enclosed) should also be located near this area. For the 21,250 GSF technical information center, the book collection (with the exception of reference books), bound periodicals, and technical reports which are stored in standard shelving will be housed in the stack area.

(1) *Space Requirements*. See Table 8-9.

TABLE 8-9 STACK AREA SPACE REQUIREMENTS

Items	Unit Area Allowance	Example Requirements	
		QTY	NASF
Shelving (Books)	9	170	1530
Shelving (Bound Periodicals)	9	469	4221
Shelving (Technical Reports)	9	120	1080
Total			6831

h. USER SEATING. Seating requirements in technical information centers differ from general libraries both in terms of quantity and type. Research activities dictate the necessity for providing individual reader stations and small table groups for group research. Provision should also be made for individual enclosed study rooms with typing and/or audio-visual equipment for the researcher that requires this type of accommodation and for the researcher who must do library research over an extended period. These reader stations should be interspersed throughout the stack area. For the 21,250 GSF information center, the following types of reader stations are postulated.

(1) *Space Requirements*. See Table 8-10.

TABLE 8-10 USER SEATING SPACE REQUIREMENTS

Items	Unit Area Allowance/Reader Station	Example Requirements	
		QTY	NASF
Research Carrels	40	2	80
Carrel Seating	30	18	540
Individual Study Rooms	36	3	108
Group Study Rooms	30	12	360
Total			1088

i. MICROFORM AREA. The microform area should be located adjacent to the control area because of the supervision and training work tasks associated with this area. This also allows easier supervision of the checking out of microreaders from this area. The microform area should have proximity to the reference area but should be physically separated due to the noise generated by the reader/printer equipment. The 21,250 GSF technical information center will provide, in addition to microform storage and reader stations, a microfiche duplicator, a copy machine, and a computer terminal.

(1) *Space Requirements*. See Table 8-11.

TABLE 8-11 MICROFORM AREA SPACE REQUIREMENTS

Item	Unit Area Allowance	Example Requirements	
		QTY	NASF
Microfilm Storage			
16mm	15	26	390
35 mm	15	10	150
Microfiche Storage	10	10	100
Reader/Printer	28	6	168
Microfiche Reader	28	8	224
Microfiche Duplicator	20	1	20
Copy Machine	60	1	60
Computer Terminal	64	1	64
Total			1176

(2) *Space Utilization Plan*. See Figure 8-7.

MICROFORM AREA SPACE UTILIZATION PLAN

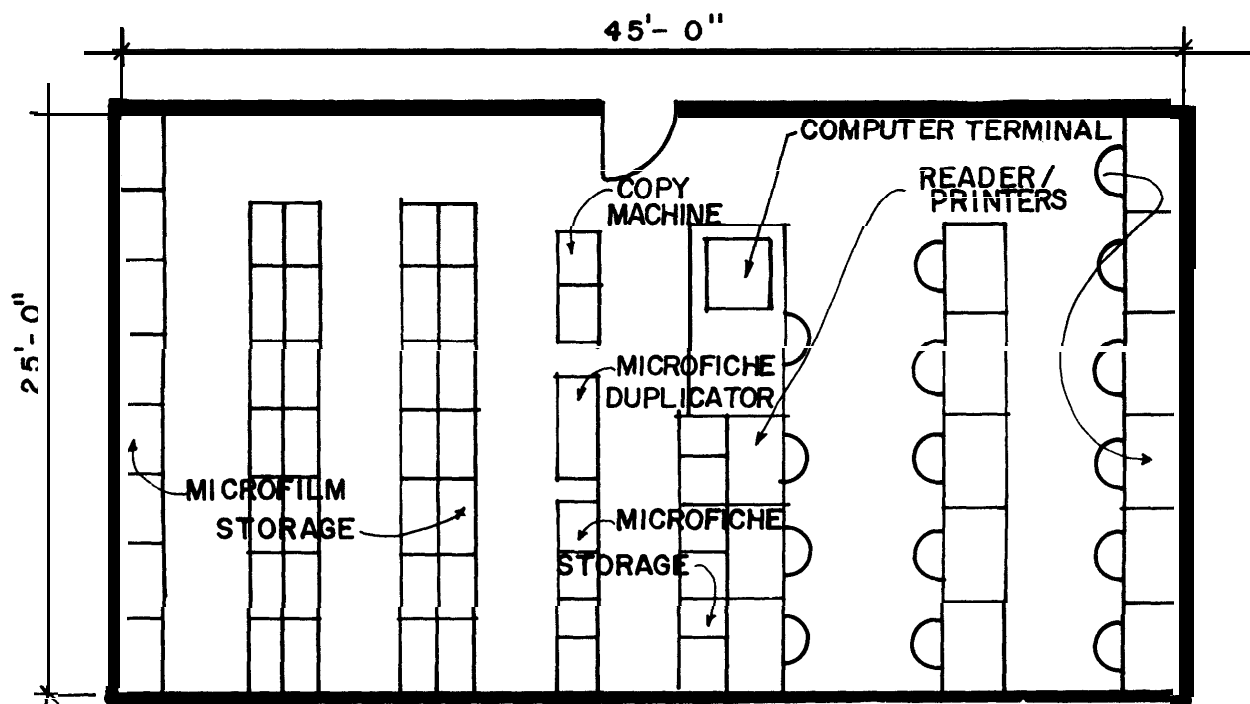

FIGURE 8-7

j. ADMINISTRATIVE OFFICES. The administrative area includes the offices of the administrative librarian, and other administrative staff members. The administrative staff is responsible for the operation of the library and its various functions. The administrative area should have proximity to both the entrance/lobby area and the technical services area. The 21,250 GSF technical information center will include private offices for the administrative librarian, the supervisory librarian, an information specialist, a writer-editor, and a translator. The administrative librarian's secretary will be provided with a secretarial work station plus an area for filing and two visitors chairs. In addition, a conference room for 10 people will be provided for staff meetings and for meetings to discuss user problems and needs. The conference room should contain a teleconference station for staff and users. The conference room should have adjacency to both staff and user areas.

(1) *Space Requirements.* See Table 8-12.

TABLE 8-12 ADMINISTRATIVE OFFICES SPACE REQUIREMENTS

Item	Unit Area Allowance	Example Requirements QTY	NASF
Administrative Librarian	150	1	150
Supervisory Librarian	125	1	125
Information Specialist	125	1	125
Translator	125	1	125
Writer/Editor	125	1	125
Administrative Clerk Typist			
Work Station	80	1	80
Files	10	5	50
Visitor Seating	30	2	60
Conference Room	30	10	300
Teleconference Room	55	1	55
Total			1195

(2) *Space Utilization Plan.* See Figure 8-8.

ADMINISTRATIVE OFFICES SPACE UTILIZATION PLAN

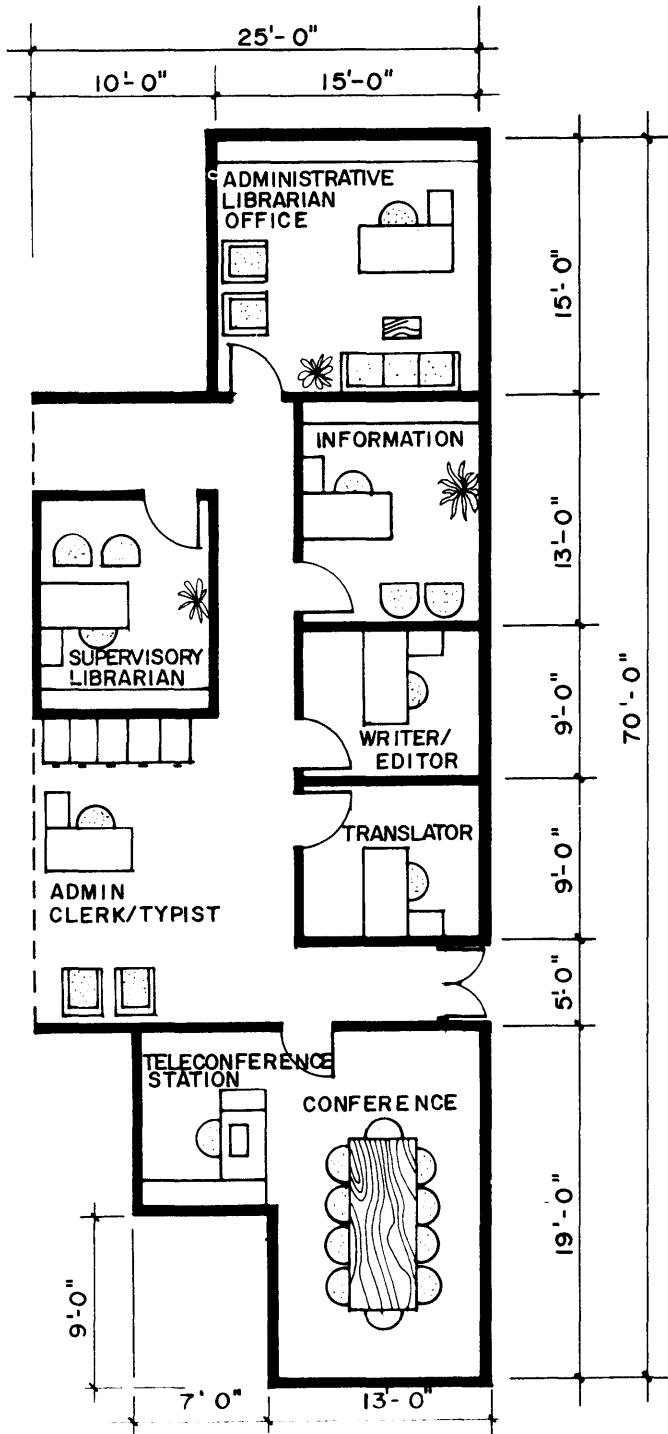

FIGURE 8-8

k. TECHNICAL PROCESSING AREA. The technical processing area accommodates all aspects of ordering and acquisition, cataloging, classification, preparation of materials for shelving and binding, and general typing and clerical work. The technical processing area should be in close proximity to the stack area and the administrative offices, if possible. It should also have close proximity to an exterior access for delivery of materials. The 21,250 GSF technical information center will provide space for a technical services librarian, a cataloger, three technicians, and two clerk/typists. In addition, a drafting table and two computer terminals will be provided for cataloging. Access to the classified collection vault will be provided through the technical processing area in order to avoid duplication of a technical processing area for classified materials alone.

(1) Space Requirements. See Table 8-13.

TABLE 8-13 TECHNICAL PROCESSING AREA SPACE REQUIREMENTS

Item	Unit Area Allowance	Example Requirements	
		QTY	NASF
Technical Services			
Librarian	125	1	125
Cataloger	100	1	100
Technician	80	3	240
Clerk/Typist	80	2	160
Computer Terminal	84	2	168
Files	10	10	100
Card Catalog	17	1	17
Book Index	50	1	50
Shelving	9	6	54
Book Truck	12	5	60
Drafting Table	80	1	80
Work Counter (incl. sink)	60	1	60
Copy Machine	60	1	60
Total			1274

(2) Space Utilization Plan. See Figure 8-9.

TECHNICAL SERVICES SPACE UTILIZATION PLAN

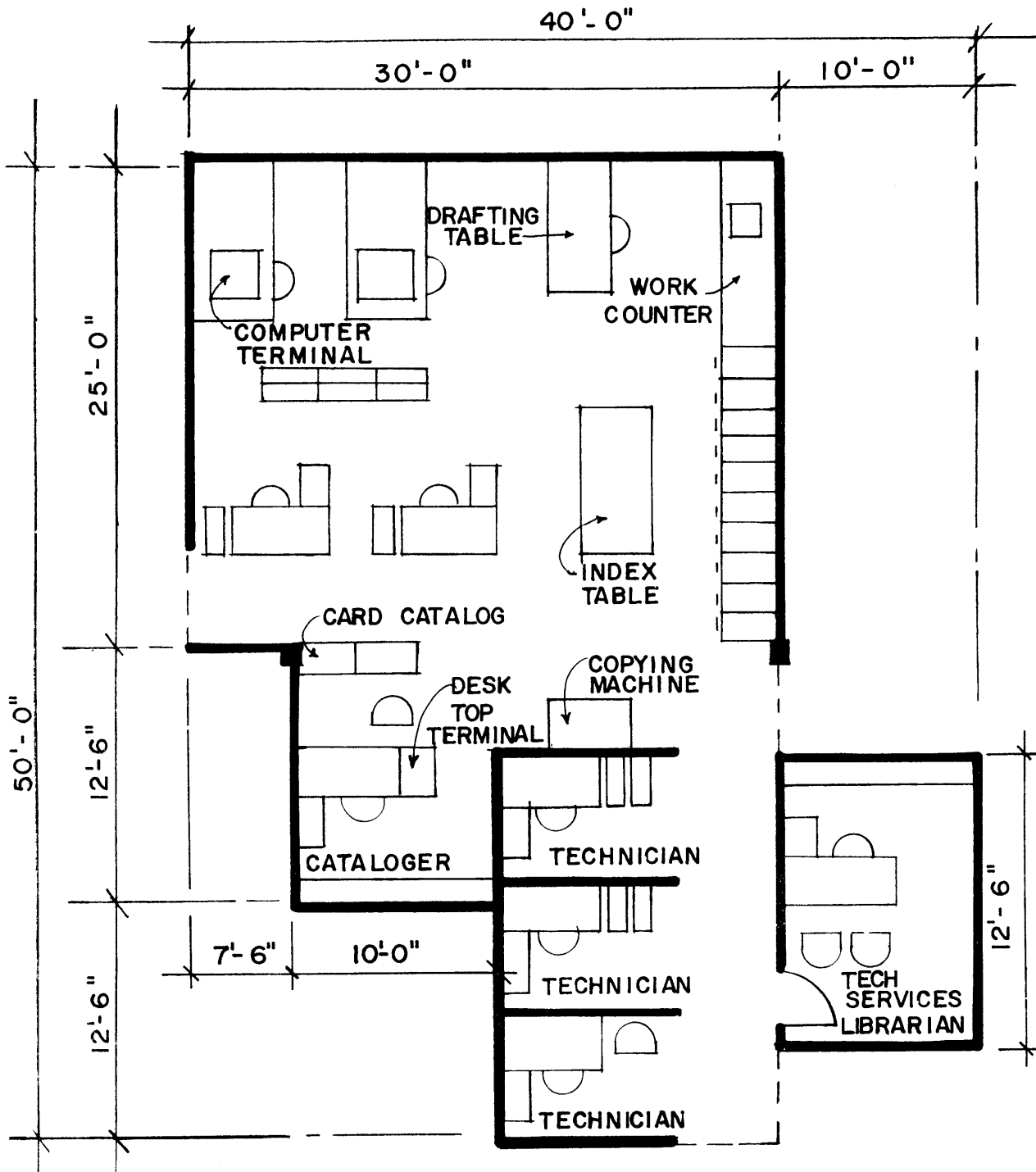

FIGURE 8-9

I. CLASSIFIED COLLECTION. The classified collection is usually located in a vault with access limited to authorized personnel only. Classified materials require the same kind of technical processing as for unclassified materials with the exception that technical processing must have the necessary security clearance. In order to avoid duplicating technical processing space, it is recommended that, where possible, classified collections be located adjacent to technical processing areas in which all personnel have the necessary security clearance.

The 21,250 GSF technical information center used as an example has a classified collection of 11,600 items. This includes 800 technical reports (2600 on shelves and 4500 in lateral files), 3200 16 mm microfilm reels, and 400 35 mm microfilm reels. In addition, a DTIC terminal is required for access to classified materials. A separate classified reading area is located at the entrance to the classified collection and contains two carrels and two reader/printers.

(2) *Space Requirements.* See Table 8-14.

TABLE 8-14 CLASSIFIED COLLECTION SPACE REQUIREMENTS

Items	Unit Area Allowance	Example Requirements	
		QTY	NASF
Technical Reports:			
Shelving	9	25	225
Lateral Files	12	25	300
Microfilm: 16 mm	15	4	60
35 mm	15	2	30
DTIC Terminal	100	1	100
Carrel Seating	30	2	60
Reader/Printer Station	28	2	56
Total			831

(2) *Space Utilization Plan.* See Figure 8-10.

CLASSIFIED COLLECTION SPACE UTILIZATION PLAN

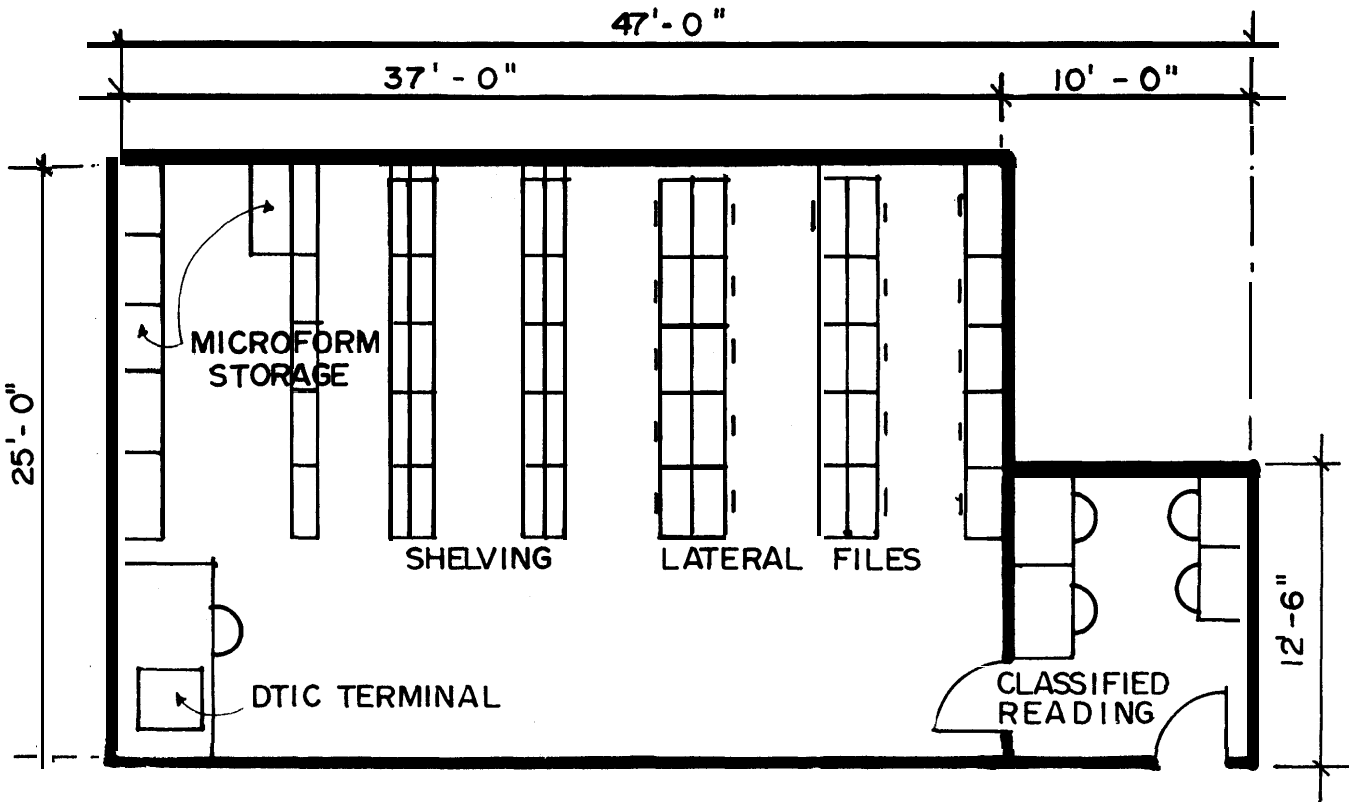

Figure 8-10

m. **STAFF LOUNGE.** The staff lounge provides an area for library staff to eat and relax and can also be used for informal staff meetings. To allow for limited food preparation, a unit kitchen should be provided. The staff lounge should be adjacent to the technical processing area and in as close proximity to the administrative and control desk areas as practicable. Lockers should be provided for library personnel who do not have private offices for storage of personal items.

(1) *Space Requirements.* See Table 8-15.

TABLE 8-15 STAFF LOUNGE SPACE REQUIREMENTS

Item	Unit Area Allowance	Example Requirements	
		QTY	NASF
Sofa	75	1	75
Lounge Chairs	30	4	120
Chairs & Tables	25/seat	8	200
Unit Kitchen	80	1	80
Lockers	4	16	64
Storage		1	50
Total			589

(2) *Space Utilization Plan.* See Figure 8-11.

STAFF LOUNGE SPACE UTILIZATION PLAN

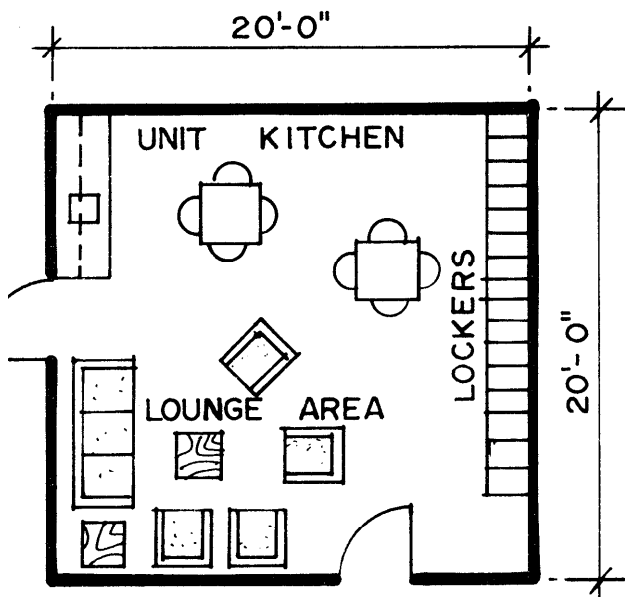

FIGURE 8-11

n. **STORAGE AREA.** A storage room should be provided adjacent to the technical processing and shipping and receiving areas for storage of unprocessed materials, library supplies, and shelving for books.

(1) *Space Requirements.* See Table 8-16.

TABLE 8-16 STORAGE AREA SPACE REQUIREMENTS

Item	Unit Area Allowance	Example Requirements	
		QTY	NASF
Shelving	9	24	216
Storage Cabinet	15	6	90
Total			306

(2) *Space Utilization Plan.* See Figure 8-12.

STORAGE AREA SPACE UTILIZATION PLAN

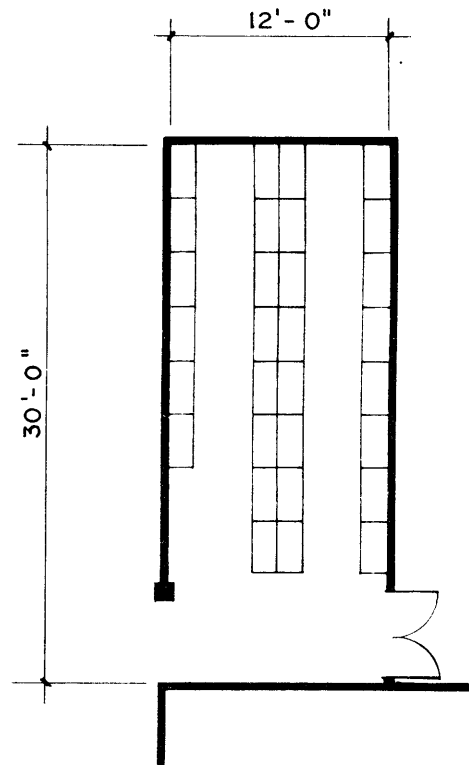

FIGURE 8-12

o. SHIPPING AND RECEIVING. Library materials must be provided with an area where items received can be checked in and stored for processing and where materials being sent out can be prepared for shipping and picked up. The shipping and receiving areas, if located on a ground floor, should have direct access to an exterior entrance if possible. If located above or below the ground level, this area should have direct access to a service corridor and/or a service elevator. Internally, the shipping and receiving area should have adjacency to a storage area and the acquisitions section of the technical services area.

(1) *Space Requirements.* See Table 8-17.

TABLE 8-17 SHIPPING AND RECEIVING SPACE REQUIREMENTS

Item	Unit Area Allowance	Example QTY	Requirements NASF
Desk & Chair	50	1	50
Work Counter	50	1	50
Storage Bins	25	6	150
Total			250

(2) *Space Utilization Plan.* See Figure 8-13.

SHIPPING AND RECEIVING SPACE UTILIZATION PLAN

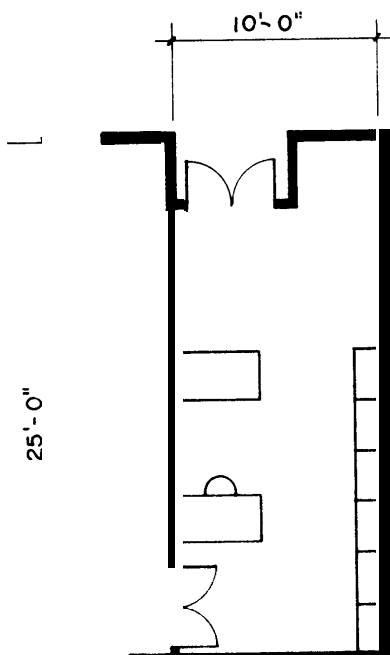

FIGURE 8-13

p. JANITOR'S CLOSET. A janitor's closet should be provided with a slop sink and shelving for storage of cleaning gear. This area will be used primarily by maintenance personnel.

(1) *Space Requirements.* See Table 8-18.

TABLE 8-18 JANITOR'S CLOSET SPACE REQUIREMENTS

Item	Unit Area Allowance	Example Requirements	
		QTY	NASF
Janitor's Closet	50	1	50
Total			50

(2) *Space Utilization Plan.* See Figure 8-14.

JANITOR'S CLOSET SPACE UTILIZATION PLAN

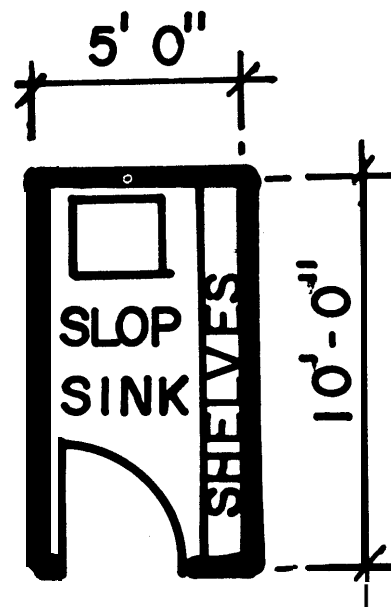

FIGURE 8-14

q. SUMMARY. Table 8-19 summarizes the space requirements for a 21,250 GSF example facility, Figure 8-15 shows a typical siting, and Figure 8-16 illustrates an example of a technical information center.

TABLE 8-19 SUMMARY OF SPACE REQUIREMENTS FOR 21,250 GSF EXAMPLE FACILITY

Space	NASF		NASF
a. Entrance Lobby	235	l. Classified Collection	831
b. Public Toilets	239	m. Staff Lounge	589
c. Card Catalog	300	n. Storage Area	306
d. Control Area	500	o. Shipping and Receiving	250
Periodical Area	1013	p. Janitor's Closet	50
e. Reference Area	2314		
g. Stack Area	6831	Total NASF	18,490
h. User Seating	1088		
i. Microform Area	1176	Core Area 15% ± NASF	2,760
j. Administrative Offices	1195		
k. Technical Processing Area	1274	GSF	21,250

TYPICAL SITING FOR TECHNICAL INFORMATION CENTER

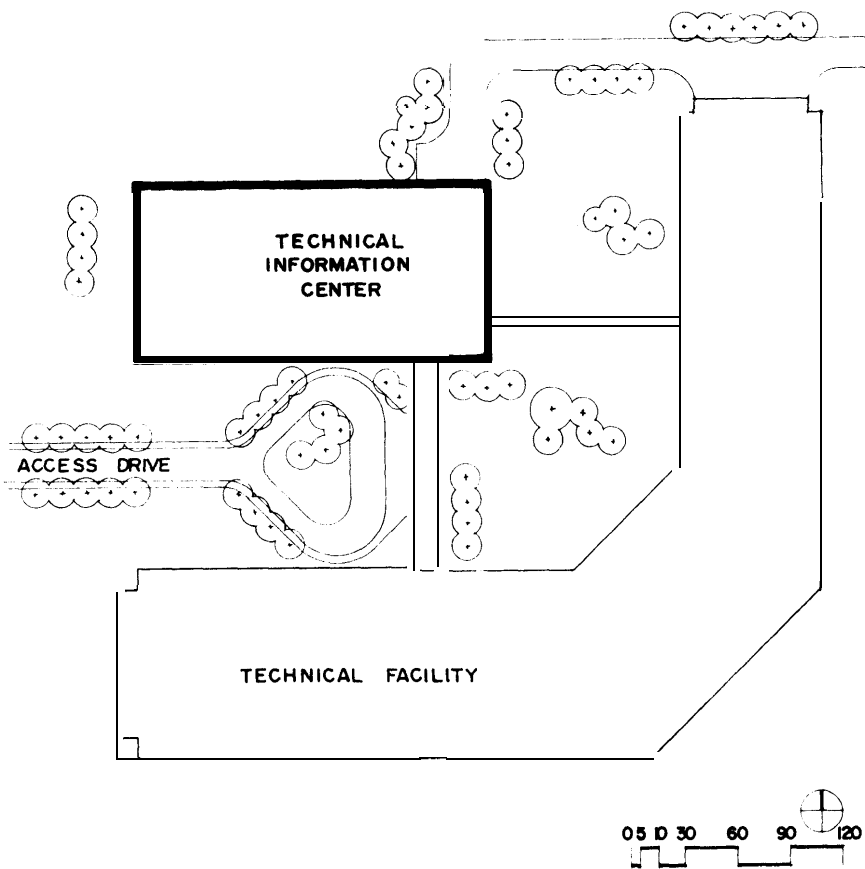

FIGURE 8-15

EXAMPLE TECHNICAL INFORMATION CENTER 21,250 GSF

4 BAYS @ 26'-7" = 106'-4"

8 BAYS @ 25'-0" = 200'-0"

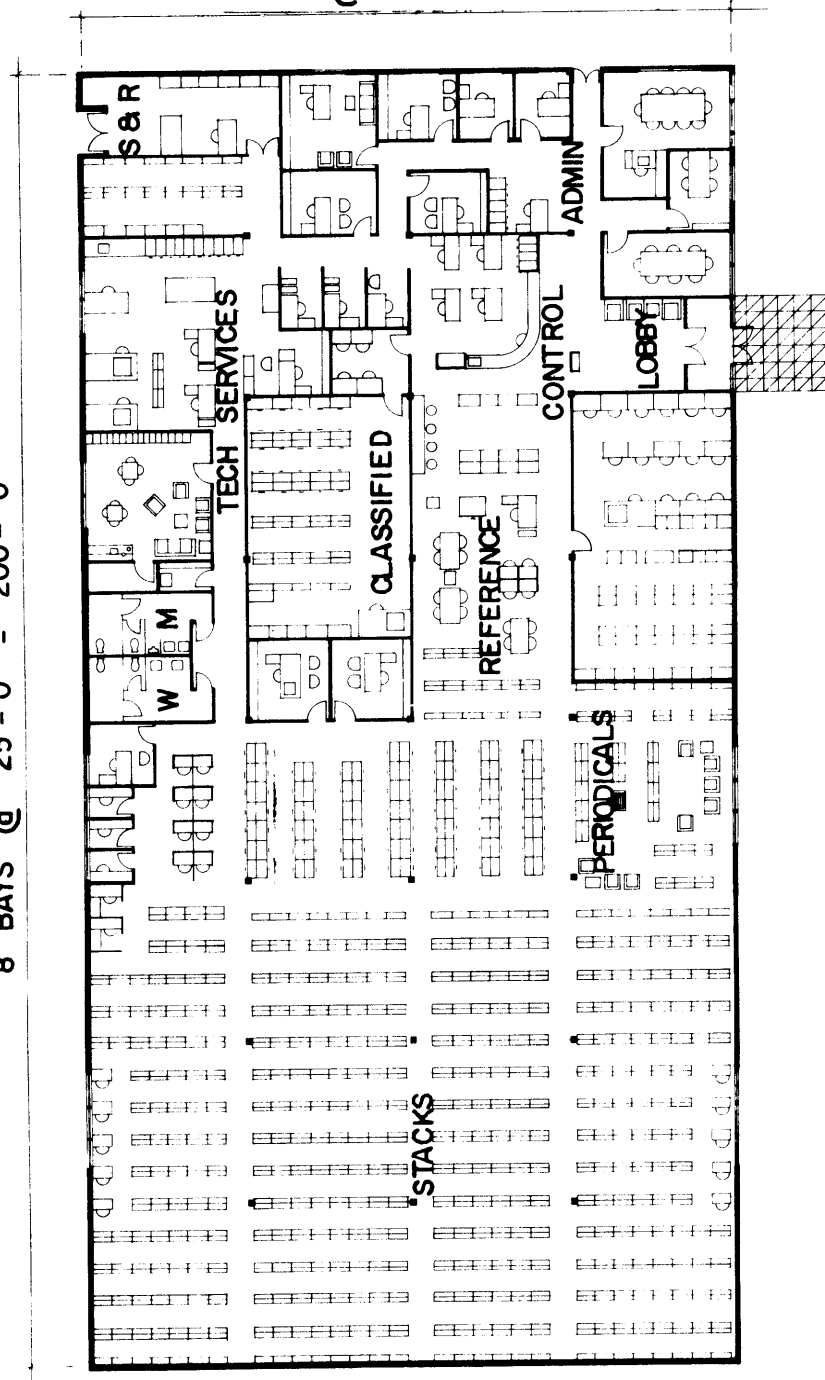

FIGURE 8-16

CHAPTER 9

School Libraries

9-1 GENERAL

The term "School Library" refers to Service School Technical Libraries which provide instructors, administrators, and students with topical reference library services oriented to the Service School's field of instruction. Most student reference material is provided in the instructional program. The "School Library" is analogous to a departmental library in a large university and is independent of Post libraries and as a rule is not accessible to persons who are not participating in the Service School program.

9-2 PLANNING AND DESIGN CONSIDERATIONS

a. **USERS.** Library users are those persons who are enrolled as students in Service School programs as well as instructors and administrators of service school programs.

b. **COLLECTION.** The basic collection consists of circulating volumes (materials which may be circulated) and reference volumes. Auxiliary collections may consist of serials, microform and audio-visual materials, and classified materials. The Chief Librarian of the Service School concerned should be requested to provide detailed data regarding the School Library Collection to the design agency involved. Table 9-1 illustrates an example collection for a 6,000 GSF School Library.

TABLE 9-1 EXAMPLE COLLECTION FOR A 6,000 GSF SCHOOL LIBRARY

<u>Type</u>	<u>No. of Items</u>	<u>Comments</u>
Circulating Volumes	11,300	
Reference Volumes	3,700	
Classified Documents	800	
Serials	250	
Microform—Audio/Visual		
Microfilm	7,550	5,000 16mm; 2,550 35mm
Microfiche	22,750	
Video Tape	125	
Audio Cassettes	225	
Sound Slides	100	
Total Collection	46,800	

c. **STAFF.** School library staff requirements are not standardized as related to size of facility, collection, or user

population. Rather, staff size is a function of the level of service required by a particular mission, hours of operation, and the range of library services provided "in-house." The example staffing shown in Table 9-2 has been developed for a 6000 GSF Service School Library which performs the full range of technical processing tasks, maintains a classified collection, and maintains a schedule of 70 library hours per week. Staffing requirements for individual school libraries should be developed by the chief librarian and forwarded to the design agency.

TABLE 9-2 EXAMPLE STAFFING FOR A 6,000 GSF SCHOOL LIBRARY

<u>Professional</u>		<u>Non-Professional</u>	
Administrative Librarian	1	Control Desk Technician	1
Reference Librarian	1	Tech. Services Technician	1
Technical Services Librarian	1	Clerk-Typist	1
Total	3		3

d. **LOCATION.** The school library should be located in the Service School in order to provide fast access for those organizational elements which use it most: administrative personnel (especially those associated with combat, doctrine and training developments); instructional staff; and secondarily, the student body. The location should be such as to not interfere with expansion of other service school facilities and to minimize disruption of library operations in the event of future library expansion.

9-3 INDIVIDUAL SPACE CRITERIA

Individual space criteria which is general to all library types is provided in Chapter 4. The criteria given below is intended to supplement Chapter 4 criteria with criteria specific to School Libraries. All spaces normally included in school libraries are listed below.

a. **ENTRANCE AND LOBBY.** The School Library should provide a minimal entrance lobby area. It should consist of no more than a vestibule of 100 NASF as outlined in paragraph 6-3.a(1). The entrance/lobby should be close to the toilets, the control and circulation desk, and the staff work area.

b. PUBLIC TOILETS. Public toilets are required for use of both public and staff during library hours. Separate facilities should be provided for men and women. The example 6000 GSF School Library will share the facilities provided by the Service School. The toilet facilities should be located in close proximity to the entrance/lobby area of the School Library in order to facilitate use by library users and staff.

c. CONTROL AND CIRCULATION DESK AREA

(1) *Adjacencies.* The control desk should be adjacent to the entrance so as to provide visual access to the public areas and to provide physical control of the entrance area. The card catalog area should be no more than 15 feet away from the control area. The control desk will also act as a control point for access to the vault which contains the classified collection.

(2) *Work Area.* A work area behind the desk is used for maintenance of files used at the control desk, processing of overdue notices, and making minor repairs to materials. The work area must include storage space for reserve materials and for equipment that is to be checked out. The work area should have close proximity to the staff work area. Table 9-3 contains the control and circulation desk space requirements and Figure 9-1 shows a space utilization plan.

CONTROL CIRCULATION DESK AREA
SPACE UTILIZATION PLAN

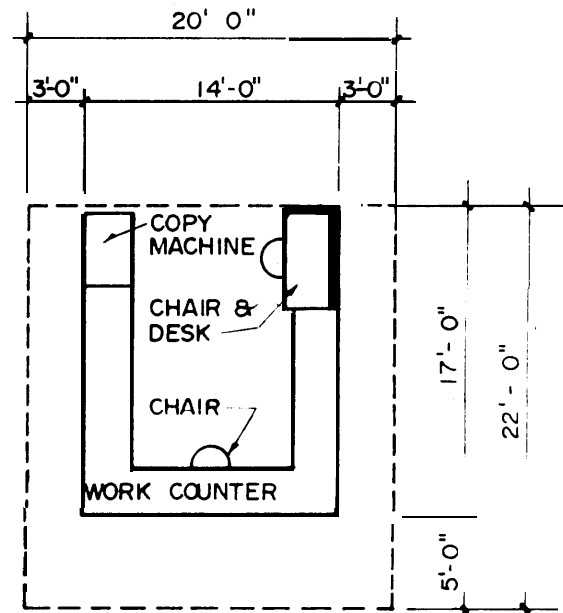

FIGURE 9-1

TABLE 9-3 CONTROL AND CIRCULATION DESK
SPACE REQUIREMENTS

Items	Unit Area Allowance	6,000 QTY	NASF
Control Desk	120	1	120
Work Counter	40	1	40
Copy Machine	60	1	60
Total			220

d. CARD CATALOG AREA. The card catalog area is used by both library users and staff to locate materials and should be located adjacent to the control area and in close proximity to the reference area. The card catalog area should also be easily accessible from the staff work area, the stack area, and the periodical area. Table 9-4 contains the card catalog area space requirements.

TABLE 9-4 CARD CATALOG SPACE REQUIREMENTS

Item	Unit Area Allowance	6000 GSF QTY	NASF
Card Tray Unit	17	2	34
Total			34

e. PERIODICAL AREA. The periodical area should be located in close proximity to the entrance/lobby and control areas. Current periodicals (serials) include journals, magazines, and newspapers are stored usually in display shelving. Shelving should be provided for current issues plus one year of back issues. Lounge seating could be provided in this area. Table 9-5 contains the periodical area space requirements and Figure 9-2 shows a space utilization plan.

TABLE 9-5 PERIODICAL AREA SPACE REQUIREMENTS

Item	Unit Area Allowance	6000 GSF	
		QTY	NASF
Display Shelving	13 1/2	8	108
Newspaper Rack	17	1	17
Lounge Seating	30	6	180
Table	20	2	40
Total			345

TABLE 9-6 REFERENCE AREA SPACE REQUIREMENTS

Item	Unit Area Allowance	6000 NASF	
		QTY	NASF
Shelving	9	42	378
Atlas Case	15	1	15
Dictionary Stand	15	1	15
Reference Librarian	125	1	125
Table Seating	25/seat	8	200
Carrel Seating	30	4	120
Total			853

PERIODICALS AREA SPACE UTILIZATION PLAN

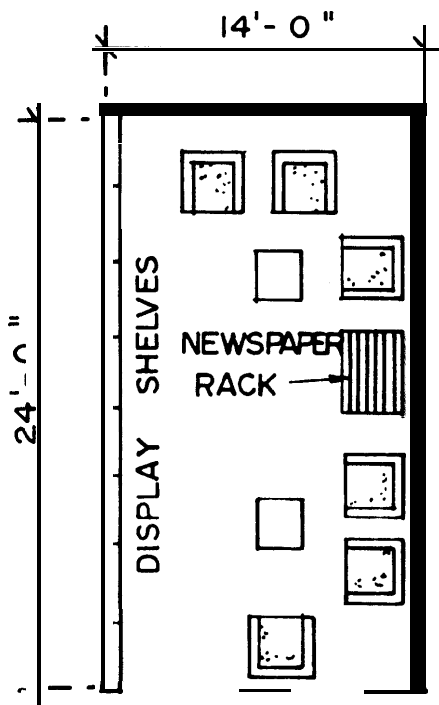

FIGURE 9-2

REFERENCE AREA SPACE UTILIZATION PLAN

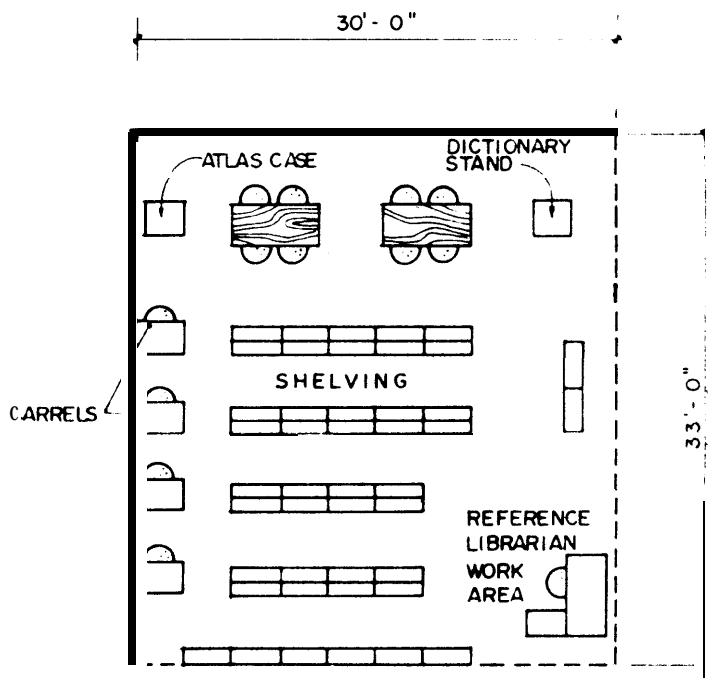

FIGURE 9-3

f. REFERENCE AREA. The reference area should be in close proximity to the card catalog area. Book stacks and microform collection should be nearby. The reference area should house reference books and abstracts. In addition, standard reference materials such as atlases, maps, and dictionaries are also located in this area. The reference librarian should be provided with a visible work station in the reference area. Microform should be adjacent. Table 9-6 contains the space requirements for the reference area and Figure 9-3 shows a space utilization plan.

g. STACK AREA. The card catalog and reference areas should be adjacent to the stack area. The staff work area should be located nearby. Stack areas should be close to and interspersed with table and carrel seating. Study rooms and individual typing/A.V. booths should also be located in proximity to this area. Table 9-7 contains the space requirements for the stack area and Figure 9-4 shows a space utilization plan.

TABLE 9-7 STACK AREA SPACE REQUIREMENTS

Items	Unit Area Allowance	6000 GSF	
		QTY	NASF
Shelving	9	110	990
Microfiche Storage	10	1	10
Microfilm Storage	15	5	75
Reader/Printer	38.5	2	77
Carrels	30	11	330
Total			1482

STACK AREA SPACE UTILIZATION PLAN

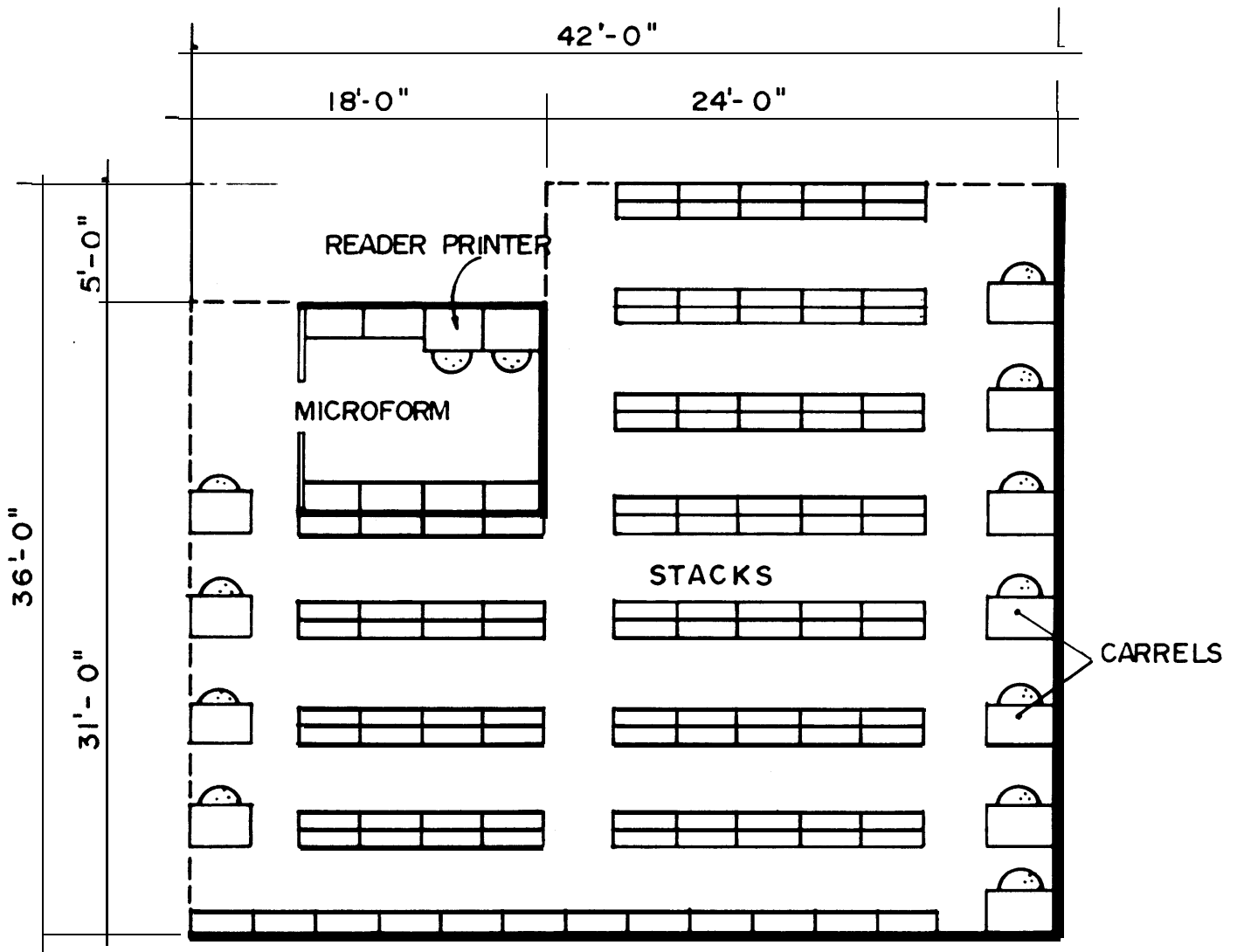

FIGURE 9-4

h. CLASSIFIED COLLECTION. The classified collection should be located in a vault area with access limited to authorized users and personnel only. Specific requirements for classified collections are outlined in Chapter 12 which should be utilized by the design agency in the development of functional requirements for classified collections.

The 600 GSF School Library has a classified collection of 3200 items. This includes 800 technical documents and 2400 microfilm reels. In addition to storage of classified materials, space should also be provided for one carrel, one reader/printer station, and a DDC terminal. It should be assumed that the size of the facility and staff and the shift work made necessary by the 70 hour/week library schedule will necessitate security clearance for all staff personnel. Table 9-8 contains the space requirements for classified collection and Figure 9-5 shows a space utilization plan.

TABLE 9-8 CLASSIFIED COLLECTION SPACE REQUIREMENTS

Item	Unit Area Allowance	6000 GSF QTY	NASF
Shelving	9	6	54
Microfilm Storage	15	2	30
Carrel Seating	30	1	30
Reader/Printer Station	38.5	1	38.5
DTIC Terminal	84	1	84
Total			237

CLASSIFIED COLLECTION SPACE UTILIZATION PLAN

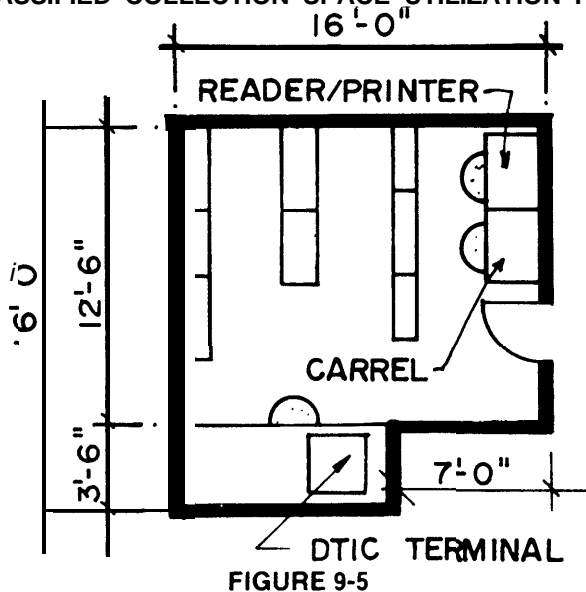

FIGURE 9-5

i. SEATING REQUIREMENTS AND GENERAL READING AREA. Seating requirements in school libraries are the same as those for Main Post Libraries as outlined in paragraph 2-4.c. The area required to store the collection in the 6000 GSF example is as follows:

Current Periodicals	125 NASF
Reference Area	408 NASF
Stack Area	1075 NASF
Classified Collection	84 NASF
Total Area for Collection	1692 NASF

User seating in the 6000 GSF school library has been provided in the periodicals, reference, classified and stack area as follows:

Area	Seating Type	No. Seats	Unit Area Allowance	NASF
Periodicals	Lounge	6	30	180
Reference	Table	8	25	200
	Carrel	4	30	120
Classified	Carrel	1	30	30
	Reader/Printer	1	38.5	30
	DTIC Terminal	1	84	89
Stacks	Carrel	11	30	330
	Reader/Printer	2	38.5	77
Total		34		1065

The remaining user seating is distributed to fill requirements for small groups and conferences, individual study rooms, and additional table seating as shown in Table 9-9. Figure 9-6 shows a reading area space utilization plan.

TABLE 9-9 ADDITIONAL SEATING REQUIREMENTS

Area	Seating Type	No. Seats	Unit Area Allowances	NASF
Group Study	Table	6	30	180
Individual Study	Table	4	36	144
Study	Table	24	25	600
Total		34		924

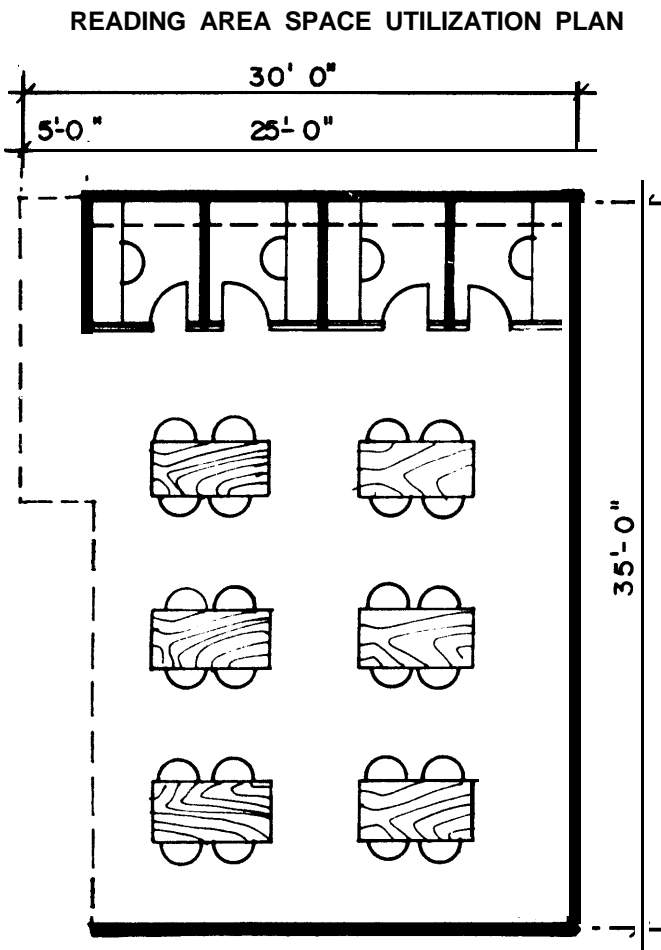

FIGURE 9-6

STUDY ROOM SPACE UTILIZATION PLAN

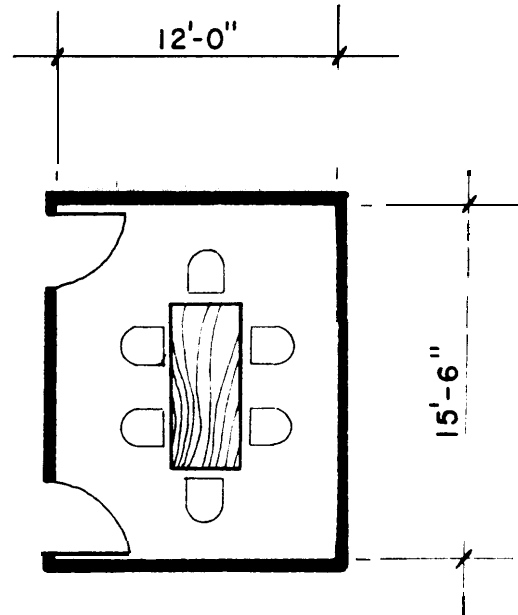

FIGURE 9-7

j. STUDY ROOM. A study room with seating for six people and audio-visual capability is provided for group study and conferences and can be utilized by both library users and staff. An area of 180 NASF should be allocated for the space. See paragraph 3.3.b. Table 9-10 contains space requirements for a study room and Figure 9-7 shows a space utilization plan.

TABLE 9-10 STUDY ROOM SPACE REQUIREMENTS

Item	Unit Area Allowance	6000 GSF	
		QTY	NASF
Conference Seating	30	6	180
Total			180

k. ADMINISTRATIVE OFFICE. An office should be provided for the administrative librarian in the 6000 GSF School Library. An area of 155 NASF should be allocated for this function. Table 9-11 contains space requirements for an administrative office and Figure 9-8 shows a space utilization plan.

TABLE 9-11 ADMINISTRATIVE OFFICE SPACE REQUIREMENTS

Item	Unit Area Allowance	6000 GSF	
		QTY	NASF
Desk & Chair	50	1	50
Sofa	75	1	75
Lounge Chair	30	2	60
Visitor Chair	15	1	15
Total			200

ADMINISTRATIVE OFFICE SPACE UTILIZATION PLAN

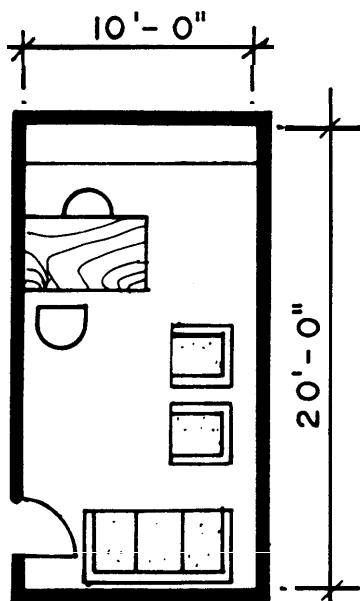

FIGURE 9-8

TABLE 9-12 TECHNICAL PROCESSING AREA SPACE REQUIREMENTS

Item	Unit Area Allowance	6000 GSF QTY	NASF
Technical Services Librarian	100	1	100
Technician	80	1	80
Clerk Typist	80	1	80
Card Catalog	17	1	17
Files	10	2	20
Book Index	50	1	50
Shelving	9	4	36
Book Truck	12	4	48
Work Counter (incl. sink)	60	1	60
Table Seating	25	4	100
Lockers	4	6	24
CRT Terminal	84	1	84
Total			699

TECHNICAL PROCESSING AREA SPACE UTILIZATION PLAN

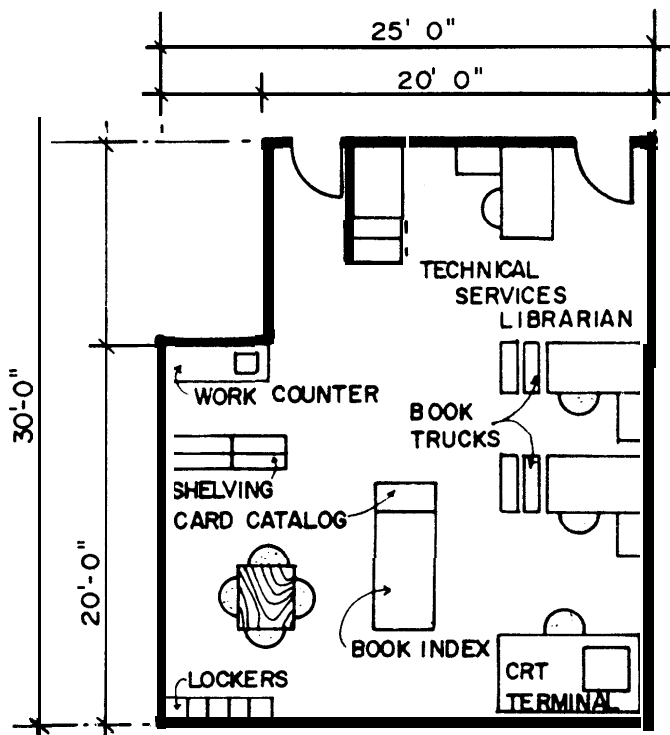

FIGURE 9-9

j. TECHNICAL PROCESSING AREA. Technical processing is responsible for all aspects of ordering and acquisition, cataloging, classification, preparation of materials for shelving and binding, and general typing and clerical work. The technical processing area should be in close proximity to the stack area, the classified collection, and the control desk. If possible, it should have convenient access to the administrative librarian's office. The technical processing area should also be in close proximity to an exterior access to facilitate shipping and receiving operations. This is particularly important when classified materials are handled and/or processed by the library. The technical processing area in the example school library will include CRT terminal for cataloging. Larger school libraries should be able to justify provision of a terminal for cataloging based on volume of materials to be processed. Table 9-12 contains the space requirements and Figure 9-9 shows a space utilization plan.

m. STORAGE ROOM. A storage room of 150 NSF should be provided adjacent to the technical processing area for the storage of processing materials and other supplies as well as extra shelving for books.

n. JANITOR'S CLOSET. This should be located in close proximity to the public toilets if possible. Space require-

ments are as provided by janitor's closet criteria in paragraph 4-20.

o. SUMMARY. Table 9-13 provides a summary of space requirements and Table 9-14 identifies adjacency relationships. An example plan layout is shown in Fig. 9-10.

EXAMPLE PLAN LAYOUT FOR SCHOOL LIBRARY

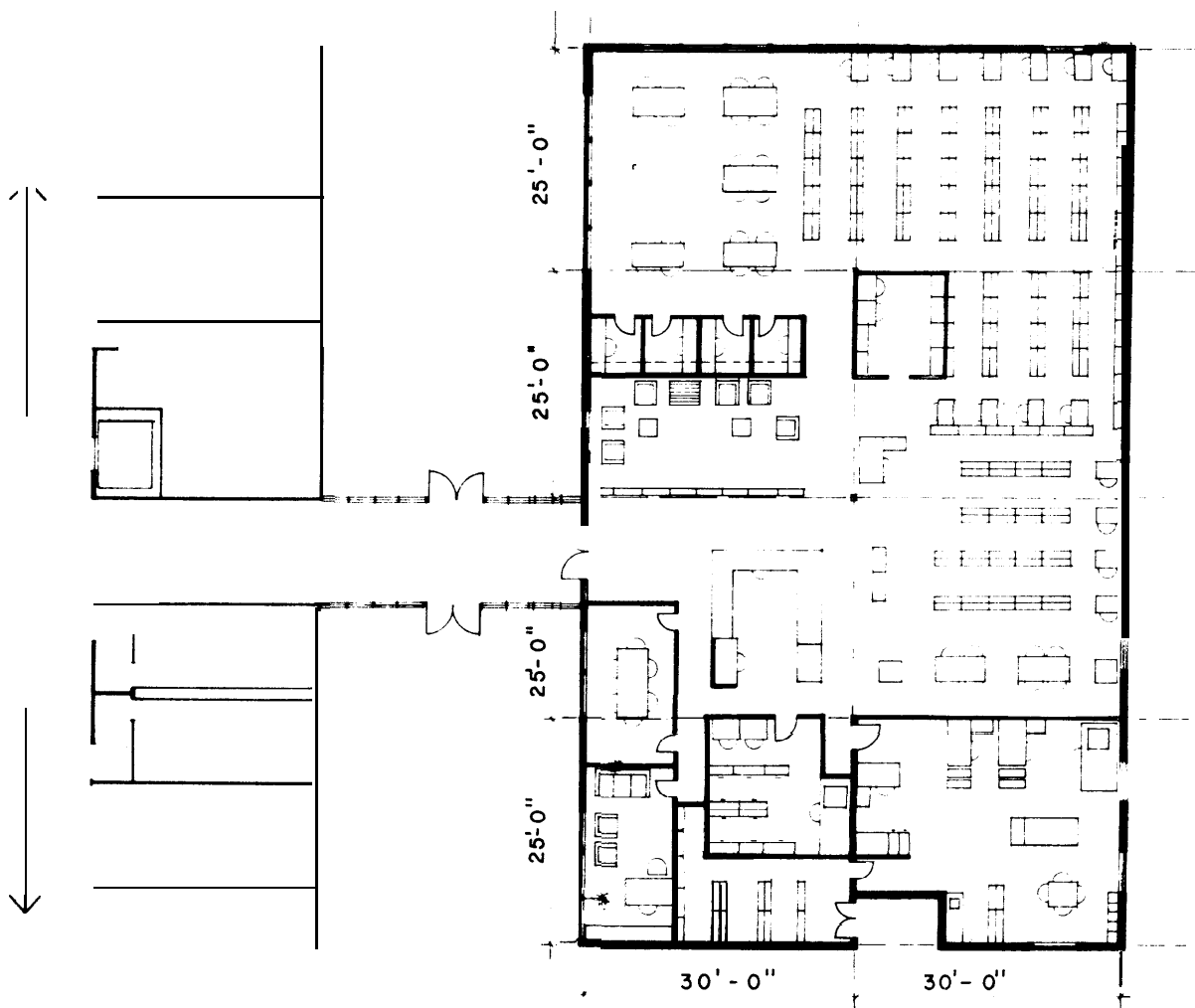

FIGURE 9-10

TABLE 9-13 SUMMARY OF SPACE REQUIREMENTS

Space	NASF
1. Entrance and Lobby	100
2. Public Toilets	—
3. Control and Circulation	220
4. Card Catalog Area	34
5. Periodical Area	345
6. Reference Area	853
7. Stack Area	1152
8. Classified Collection	237
9. User Seating (Stack/Reading Area) *	1153
10. Study Room	180
11. Administrative Office	200
12. Technical Processing Area	699
13. Storage Room	150
Total	5323
Core Area 15% ± SF	677
GSF	6000

*Seating for all other areas are included in requirements for specific areas

TABLE 9-14 IDENTIFICATION OF ADJACENCY RELATIONSHIPS

Space No.	Space Name	Adja-cent	Near 25	Near 75	Isolated
1.	Entrance and Lobby	2,3	11,12		7,9,10
2.	Public Toilets	1	3,14		
3.	Control and Circulation	1,4,8	12		
4.	Card Catalog Area	3,6			
5.	Periodical Area	6	7		
6.	Reference Area	4,5	7		
7.	Stack Area	9,10	5,6		1
8.	Classified Collection	3,12			
9.	Stack/Reading Area	7			1
10.	Study Room	7			1
11.	Administrative Office		1,12		
12.	Technical Processing Area	8,13	1,3		
13.	Storage Room	12			
14.	Janitor's Closet		2		

CHAPTER 10

Medical Libraries

10-1 GENERAL

Medical libraries are programmed by the U.S. Army Health Facility Planning Agency as part of their overall programming effort for military hospitals. Therefore, this chapter only discusses medical library facilities, in a general way, for military hospitals. Medical libraries in both teaching and non-teaching hospitals are for staff use only. Patient libraries, when provided, usually have separate collection and reading areas, but may share common control and technical service areas with the medical libraries.

A medical library is an integral part of a medical facility and is established for the purpose of providing professional education and research materials for the hospital medical staff. These libraries may be established at all medical centers and hospitals subject to the approval of the Office of the Surgeon General.

a. REFERENCES. AR 40-2 Army Medical Treatment Facilities General Administration, 10-0-10.3; Attachment G, Circular No. A-57, Administrative Space Planning Criteria for Federal Hospitals.

b. FUNCTIONS OF MEDICAL LIBRARIES. Medical libraries usually perform all or some of the following functions as appropriate considering local requirements.

(1) *Medical Reference*. Make available to the medical and allied staff reference material concerning the most recent as well as historical developments in medicine, surgery, and other specialties in the medical and allied fields. The compilation of reference lists and bibliographies is an integral part of the reference function of the medical library. Related reference work consists of interlibrary loan services, assistance in the preparation of the professional papers, and assistance to medical journal organizations to facilitate the interchange of information on Army trends. Medical references include the use of secondary sources such as Index Catalogs to the Surgeon General's Library, Current List of Medical Literature, Quarterly Cumulative Index Medicus, Cumulated Index Medicus, Current Index Medicus, abstract journals, and special bibliographies.

(2) *Journal and Book Selection*. The medical librarian, subject to review and final selection by the Medical Library Committee, recommends books and journals to be purchased, discarded, replaced, or rebound. Recommendations for additions to the library are to be based upon scope of the subject as related to the needs of the medical program and the present book stock and periodical subscriptions. Recommendations for retention or removal of material are based on its use, indications of future needs and requests, condition of material, and budgetary limitations.

(3) *Training Medical and Allied Staff in Use of Library*. Conduct a continuous program of orientation lectures and instructions for the purpose of training the medical and allied staff in the use of medical reference tools and inform users of the types of reference and other services available.

(4) *Cataloging of Materials*. Catalog, classify, and arrange medical library collections in such a manner as to insure their ready access.

(5) *Referring Literature to Appropriate Individuals*. Make a continuing examination and analysis of all journals, books, pamphlets, and other materials upon their receipt in the library to determine possible application to all studies and research programs either planned or presently conducted by the staff and to bring pertinent material to the attention of the individual concerned.

(6) *Promoting Use of Medical Library and Facilitating Interlibrary Loan of Material*. Develop effective public relations within the medical facility in order to promote the use of the medical library resources and to attain maximum use of medical literature. Also, maintain professional relationships with other medical library staffs and actively participate in the National Library of Medicine's Regional Library Program to ensure full cooperation in the interchange of information and interlibrary loan materials.

10-2 PLANNING AND DESIGN CONSIDERATIONS.

a. LIBRARY USERS. As distinct from a general library, the medical library, both teaching and non-teaching facilities, usually serves a tripartite mission—patient care, education and research. Library users consist of three primary groups: the professional medical staff including all of the health profession groups from occupational and physical therapists to physicians; in teaching hospitals, students form a strong user group for library services. Students consist of the interns, residents, nurses, and other allied health profession groups which use hospital facilities for training purposes; and support staff which is the least intensive user group in the hospital.

b. STAFF. The number of medical librarians and technical staff required to staff the medical library should be in relation to the type and amount of administrative and operational duties, to include reference work, resulting from the size of the medical and allied staff, and the teaching and research programs of the medical facility. Assistant medical librarians may be employed when the need exists, subject to the approval of the major commander concerned. Staff requirements should be developed in conjunction with the chief librarian subject to final approval of the major commander.

c. COLLECTION. Generally, the medical library collection may be developed using the following guidelines:

(1) *Classifications*. Classification of books and periodicals should be determined locally in accordance with accepted library practices.

(2) *Acquisition*. In selecting books and periodicals for acquisition, the following principles are usually considered:

(a) Books are selected in response to the needs of the staff of the medical facility. With few exceptions, books and monographs should have been published within the last 10 years. Representatives of all staff groups should be consulted concerning medical book procurement.

(b) Current medical periodicals and publishers' catalogs and announcements should be reviewed regularly for listings of new books. A file of current publishers' catalogs should be maintained.

(c) The following materials are generally used in the selection of medical books, periodicals, and journals:

R. R. Bowker's *Medical Books in Print*—a comprehensive list of medical books issued by all medical publishers in America.

Ulrich's *International Periodical Directory*—a listings of periodicals of every field.

(3) *Periodicals*. Each library may subscribe to a selection of periodicals covering the various specialties in the medical facility program. The list may be reviewed each year to eliminate those periodicals not used but only after due consideration of the mission of the facility and the probability of future requirements for this subject matter. The principles pertaining to book selection are also applicable to periodical selection. These principles should be supplemented by giving consideration to the procurement of abstract periodicals in order to provide for a broader coverage of the field of periodical literature than would be possible by the procurement of individual titles under a limited budget. Although it is recognized that many staff personnel other than physicians and nurses make use of the hospital medical library, the full time equivalent employment of physicians and nurses has been considered to be a reasonable index for measurement of library collection requirements.

d. *READER STATIONS*. There are three potential user groups for which reader stations may be provided: the professional staff which includes physicians, nurses, and allied health professionals; the student group, in the case of teaching hospitals, including residents, interns, nurses, and allied health students; and the support staff. Each of these groups exerts a different pressure on the library facility. It has been found that students exert nearly three times the pressure for services and space than the professional staff does, whereas the support staff exerts very little pressure at all.

3. *LOCATION*. The medical library is usually located in the hospital building, accessible from a major corridor, and should not require access through another department. It should be easily accessible from the main entrance of the hospital. Convenience to the heavy users is more important than equal convenience to all eligible users.

10-3 INDIVIDUAL SPACE CRITERIA

Individual space criteria which are considered general to all library types have been provided in Chapter 4. The criteria given below are intended to supplement the information in Chapter 4 with criteria specific to medical libraries in both teaching and non-teaching hospitals. Figure 10-1 illustrates the spatial relationships of areas described.

a. *ENTRANCE AND LOBBY*. The medical library is located in a hospital building. For that reason, the lobby and entrance area in the library itself can be kept to a minimum. It should also be adjacent to the card catalog area and have reasonable proximity to public toilet areas.

b. *CARD CATALOG AREA*. The card catalog area is used by both library users and staff to locate materials and should be adjacent to the circulation desk, in close proximity to the reference area, and should be visible as one enters the library. The card catalog should also be easily accessible from the staff work area. In such an environment, the card catalog should provide easy consultation space either on top of the catalog itself or via pull-out shelves in the catalog cabinet. For larger card catalog areas, a consultation table close at hand is required.

c. *CIRCULATION DESK AREA*. The circulation area provides space to maintain records of materials charged to readers, to provide assistance and direction of the usual circulation activities; to provide space for the return of library materials; and generally to provide visual control of entrance/lobby area. The circulation desk should be immediately adjacent to the entrance/lobby area as well as providing close proximity to the card catalog, the reference area, and the administrative librarian. It is also helpful to be close to the staff work area. An after-hours book return should be provided as well as a book return at the circulation desk.

d. *PERIODICAL AREA*. The periodical area houses current periodicals and provides easy access to other unbound issues of the current year. This area should be adjacent to the circulation desk and the entrance/lobby area. It should also have close proximity to the staff work area. The copy machine, if provided, should be in close proximity to this area. Lounge type seating should be provided in this area.

e. REFERENCE AREA. The reference area provides accommodations for printed bibliographies, abstracts, indexes, handbooks, dictionaries, encyclopedias, and other heavily used reference material. The reference area should be visible from the entrance/lobby area. The reference librarian, if provided, should have a desk in this area in order to provide general reference service and to provide access to the MEDLINE terminal in the case of MEDCEN/Teaching Hospital Medical Libraries. The MEDLINE terminal should not be at the reference desk, but located in a relatively isolated space due to the fact that this activity often involves intense concentration and consultation. The heavily used indexes should be accommodated at index tables.

f. STACK AREA. The stack area houses the bound periodicals and the monograph portion of the collection. The bound periodicals portion of the collection should be near the reference collection/MEDLINE area since much use of this material will be generated by these activities. A variety of reader stations should be close to these stacks in order to accommodate the intense use that this part of the collection will receive. As with unbound periodicals, this element should be near the copy machine and the microform area. Stack areas should be close to and interspersed with table and carrel seating.

g. USER SEATING. Reader stations are dispersed throughout the library in the current periodicals area, the reference area, the stack areas, and the A/V area. Reader station requirements are based on staff and students served. Research and reference activities in medical libraries dictate the necessity for providing individual reader stations and small table groups. Some of the individual carrels may also be equipped as A/V learning centers. Readers and reader/printer stations should also be provided when microform materials are part of the collection.

h. MICROFORM/AV AREA. The microform/AV area, if included, should provide storage for information in various microformats, user space for readers and reader/printers, and storage for a variety of non-print media. This area should be located adjacent to the staff work area because of the supervision and training work tasks associated with this area. This also allows easier supervision of the checking out of A/V materials for use at the study carrels which are equipped with A/V facilities. Since it is likely that much of the material held in microformats will be periodicals, this area should be in close proximity to the periodical collection.

i. LIBRARIAN'S OFFICE. The head librarian provides direction to the library staff and coordinates the library's efforts with those of the rest of the hospital. If possible, a private office should be provided for staff and user consultation. If the staff is small, the librarian needs to be in

the midst of the staff operations, and at the same time must be easily available to consult with library users. The two most significant interfaces are with the circulation desk and the staff work area. In larger facilities, the head librarian may require a secretary to supply clerical support and to maintain records. In addition, in a larger facility, a conference room should be provided for use by both staff and larger users. If provided, it should also be equipped as a media room for group study.

j. TECHNICAL PROCESSING AREA. The technical processing area provides storage and space for the non-public service functions of the library such as shipping and receiving, processing, preparing materials for binding, ordering, cataloging, interlibrary loan processing, record storage, and other support services. This area should be adjacent to the librarian, the circulation desk and card catalog, the reference area, and the stack area. This is a high use, high noise area and should be isolated from the quiet study areas of the library. A work counter and sink should be provided for pasting and other operations.

SPATIAL RELATIONSHIP DIAGRAM

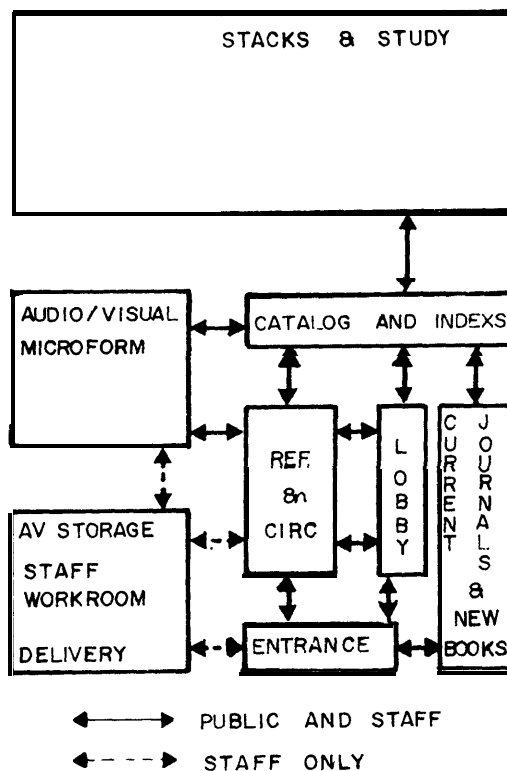

FIGURE 10-1

CHAPTER 11

Law Libraries

11-1 GENERAL

Army law libraries are defined as collections of legal and legislative reference materials maintained by judge advocates or legal officers of commands, installations, and activities and; are utilized as the legal reference centers for the commands, installations, or activities concerned. AR 27-5, Army Law Library Service, is the applicable regulation for this facility category.

Army law library managers will recommend to the Commandant, The Judge Advocate General's School, U.S. Army, Attn: JAGSDDS, Charlottesville, VA 22901 (TJAGSA), the establishment of additional libraries when needed. Upon TJAGSA approval and subject to the availability of funds, a library account number will be assigned to the new library, and instructions concerning initial selection of materials will be forwarded to the requesting manager by the Army Law Library Service (ALLS).

a. **MINIMUM FUNCTIONAL INVENTORY (MFI).** The MFI is a list of law library materials normally required to carry out the functions of a legal office, and is compiled by legal specialty within Army law office functional areas. The ALLS will purchase those materials on the MFI upon request of any Army law library.

b. **LOCATION OF LIBRARIES.** The Army law library should be maintained as a separate entity to the extent possible. It will be housed in the office of the Staff Judge Advocate, ranking legal officer, or general counsel of the command concerned, and should be readily accessible to the legal staff. Where desirable or more economical, and with the approval of ALLS, a law library may be administered through a general or technical library.

11-2 PLANNING AND DESIGN CONSIDERATIONS

a. **LIBRARY USERS.** Army law library users may vary with each library, but law libraries are maintained primarily for the use of lawyers and other persons with legal background. The person who is designated as the accountable officer of the library should identify potential users and supply this information to the design agency for planning purposes.

b. **THE COLLECTION.** The size and variety of the legal collection depends on the MFI for the library concerned. Table 11-1 outlines the contents of a sample law library of 1,000 GSF.

c. **READER STATIONS.** Army law library users require seating in the library for doing legal research. Leisure reading areas should not be provided. Table seating and

**TABLE 11-1 EXAMPLE COLLECTION FOR A 1000 GSF
ARMY LAW LIBRARY**

1. Reference and Legislative Materials
 - a. Legal Encyclopedias
 - b. Legal and General Dictionaries
 - c. Legal Directories and Forms
 - d. Federal Legislation U.S. Code
U.S. Code Annotated
 - e. Army Regulations
 - f. State Statutes
 - g. U.S. Supreme Court Reports Digests
 - h. Federal Reporter and Federal Supplement
 - i. Regional Reporter and Digest
 - j. Shepard Reporter Citations
 - k. Legal Periodicals
2. Treatises
 - a. Administrative Law
 - b. Contracts
 - c. Criminal Law and Criminal Procedure
 - d. Domestic Relations
 - e. Labor Law
 - f. Environmental Law
 - g. Real Property
 - h. Torts
 - i. Veterans and Military Personnel

3. Military Law

Total Collection Size	3500 Volumes
-----------------------	--------------

carrels provide the best accommodation for research. Based on a sampling of 85 county law libraries, the rates of user seating area to collection storage area is approximately 1:2. Seating space should be provided based on 50 percent of the collection storage area.

d. **STAFF.** Army law libraries may or may not be staffed on a full-time basis depending on the size and mission of the facility. An officer, warrant officer, professional civilian librarian, or a responsible civilian member of the staff may be designated as the accountable officer by the installation commander. Staffing requirements should be determined on a case-by-case basis by the installation commander and transmitted to the design agency. The typical 1000 GSF Army law library has one full-time civilian technician to staff the library.

11-3 INDIVIDUAL SPACE CRITERIA

Individual space criteria which is general to all library types is provided in Chapter 4. The criteria given below is intended to supplement Chapter 4 criteria with criteria specific to Army law libraries. All spaces normally included in Army law libraries are listed below.

a. **STACK AREA.** The stack area houses the entire legal collection including all reference and legislative materials, legal periodicals, treatises, and military law materials. Army law libraries are not usually equipped with card catalog files. However, most legal reference material is prepared in series/volume format and is relatively easy to access without benefit of a card file. Stack areas should be so arranged to facilitate storage of like materials in the same location. Reader stations should be directly adjacent to and/or interspersed with the stack area. For a collection of 3500 volumes, the following space shown in Table 11-2 should be provided.

TABLE 11-2 STACK AREA SPACE REQUIREMENTS

Item	Unit Area Allowance	1000 GSF	
		QTY	NASF
Shelving	9	56	504
Total			504

b. **READING/STUDY AREA.** Seating requirements are based on criteria outlined in paragraph 11-2.c. The total seating area which should be provided in the example design is 0.5 x 504 or 252 NASF. Based on the provision of table seating at a 25 NASF/station, the number of seats specified in Table 11-3 should be provided.

TABLE 11-3 READING/STUDY AREA SEATING REQUIREMENTS

Item	Unit Area Allowance	1000 GSF	
		QTY	NASF
Table Seating	25 NASF/station	12	300
Total			300

c. **STAFF WORK STATION.** Staff work areas require minimal space in most law libraries and, in some cases, require no space when the library is not staffed. For the example design, the full-time staff person should be provided a desk, filing cabinet, and a visitor's chair for consultation. The staff work station should be located adjacent to the entrance for control and consultation purposes. Table 11-4 provides staff space requirements, Table 11-5 contains a summary of law library space requirements, and Figure 11-1 shows a law library space utilization plan.

TABLE 11-4 STAFF SPACE REQUIREMENTS

Item	Unit Area Allowance	1000 GSF	
		QTY	NASF
Work Station	80	1	80
Files	10	1	10
Visitor's Chair	10	1	10
Total			100

TABLE 11-5 SUMMARY OF SPACE REQUIREMENTS

Item	NASF
a. Stack Area	504
b. Reading/Study Area	300
c. Staff Work Station	100
Total	904
Core Area 15% ± NASF	96
GSF	1000

LAW LIBRARY SPACE UTILIZATION PLAN

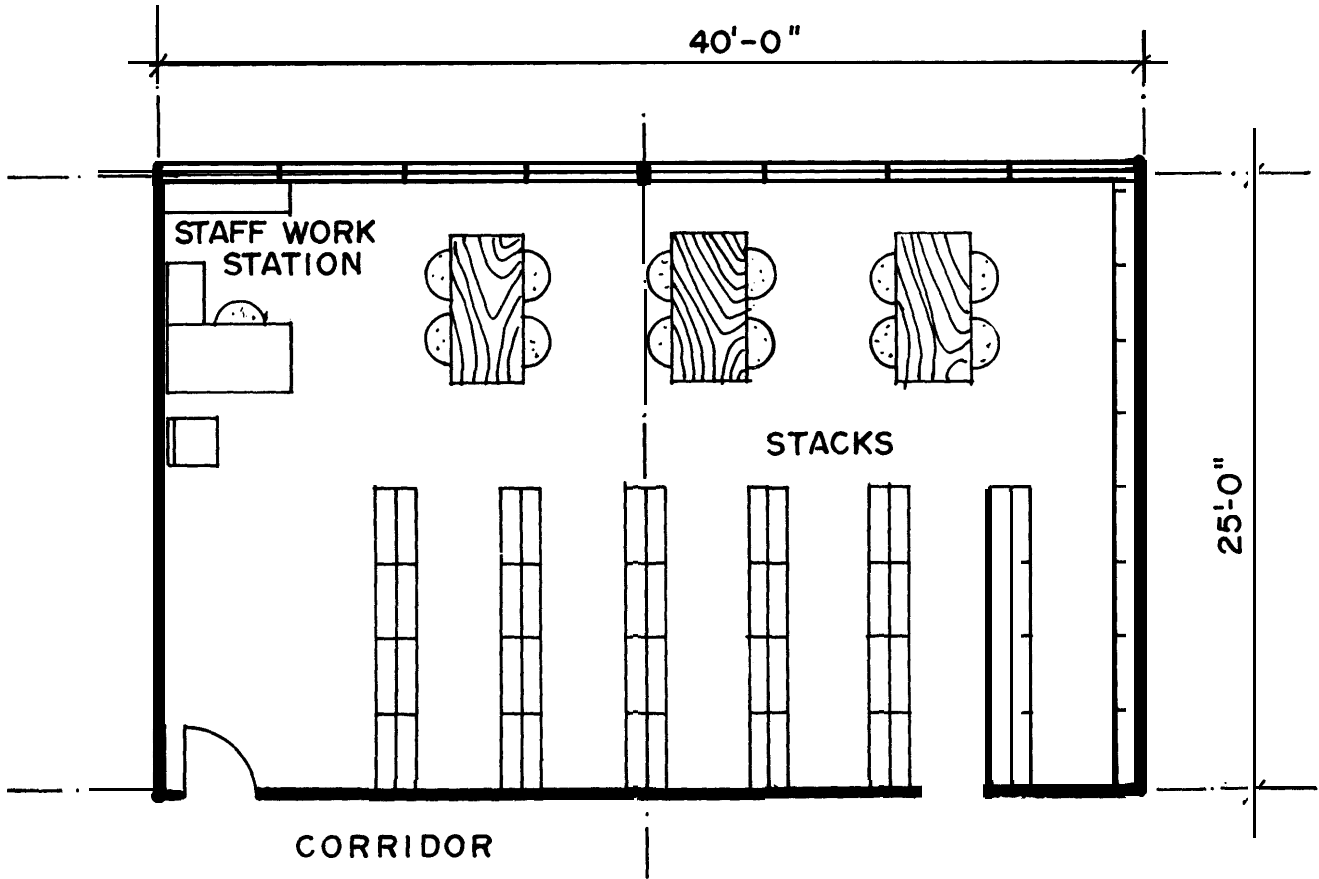

FIGURE 11-1

CHAPTER 12

Classified Collections

12-1 GENERAL

Classified collections are established as needed to provide controlled access to classified documents and/or other classified information materials to persons who have the required security clearance. Classified collections are normally incorporated as a part of other libraries such as scientific and technical information facilities or service school libraries. The users handbook for the Redstone Scientific Information Center (RSIC) is a good reference for this type of facility.

12-2 PLANNING AND DESIGN CONSIDERATIONS

a. **USERS.** Classified collection users usually consist of military personnel, government contractors, academic personnel, and others who have obtained the necessary security clearance for access to the classified materials in the collection.

b. **STAFF.** Library staff members who work with the classified collection in any way including shipping and receiving, cataloging, reference, circulation, etc., must have the necessary security clearance in order to do so. In smaller libraries with classified collections, all staff personnel usually will have security clearance in order to provide as much staff flexibility as possible in the case of shift work, absences, etc. In larger libraries with classified collections, only certain staff members, who work exclusively with the classified collection, may be provided with security clearance. In these cases, technical processing and all other library services related to the classified collection are separated from the library services for all other parts of the library collection (usually in a vault). Staff size for classified collections must be developed by the chief librarian and supplied to the design agency.

c. **COLLECTION.** Classified collections usually consist of technical and military documents in hard copy form and/or microform. In some cases, a Defense Technical Information Center (DTIC) terminal, for accessing classified materials, will be included as part of the classified collection. If such a terminal is included, area requirements are greatly expanded due to the space required for the equipment (terminal, printer, scramblers, etc.). Table 12-1 illustrates an example collection for a 1000 GSF classified collection.

TABLE 12-1 EXAMPLE 1000 GSF CLASSIFIED COLLECTION

Item	No. of Items
Technical Documents	7,000
Microfilm	
35mm	400
16mm	800
Microfiche	38,000
Total Collection	46,200

d. **READER STATION.** Reader stations for persons using classified materials must be separated from the reader stations in other areas of the library. Reader stations for classified collections must be provided with controlled access and are usually located in the same area where the collection is stored (vault) or in a controlled access area directly adjacent. Carrel seating is the most appropriate type for hard copy documents whereas readers and reader/printers must be provided if parts of the classified collection are held in microform. The number and type of reader stations must be developed by the chief librarian on the basis of the format of the collection as well as the number of daily users.

e. **LOCATION.** Classified collections are usually included as part of other libraries such as scientific and technical libraries or service school libraries. Within the library, the classified collection is housed in a controlled area or vault. The entrance to this area must be as close as possible to the staff work area so that classified mail can come directly into the vault. Classified materials must move from receiving to cataloging and processing without leaving the controlled area. The circulation area and reading area for the classified collection should be located adjacent to the main circulation desk of the library for convenience of users as well as staff.

12-3 INDIVIDUAL SPACE REQUIREMENTS

Individual space criteria which is general to all library types is provided in Chapter 4. The following criteria introduces criteria specific to classified collections. All spaces normally included in classified collections are listed below. Refer to Table 12-2 for a summary of space requirements. Figure 12-1 illustrates a spatial relationship diagram and Figure 12-2 shows an example of a classified area layout.

a. **CONTROL AREA.** The control area of the library proper should be located so that access to the classified collection is capable of being monitored by the main control desk. Persons with the necessary security clearance may enter the collection area only if escorted by a staff

member. The control area should be separated from the collection area by a locked door equipped with a security alarm. There must be continuous visual control of all doors securing the vault area.

b. CARD CATALOG AREA. The card catalog which contains information regarding only the classified collection, should be accessible only to persons with security clearance. This area should be located adjacent to or inside the classified vault area. The card catalog should also be adjacent to the classified reading area.

c. STACK AREA. The staff work area should be located directly adjacent to the stack area containing the classified collection. Reader stations should be separated from the stack area by a control point in order for staff members to control stack access within the vault area.

d. READING AREA. The classified reading area should be located adjacent to the control area inside the vault and should have direct access to the classified card catalog. Study carrels should be provided for use of classified materials in hard copy whereas reader/printers and/or readers should be provided for use of the microform collections.

e. STAFF WORK AREA. The staff work area for the classified collection should be located in the vault and should act as a control point between qualified users and the stack area and DTIC terminal. This area should serve as both a circulation and control area and for processing of all classified materials. The area should also be as close as possible to the shipping and receiving point of the library in order to facilitate and security aspects of classified materials being received or dispatched.

f. DTIC TERMINAL AREA. The DTIC terminal for access to classified materials should be located in the vault adjacent to the stack area so that the staff work area can be used as a control point for access to the terminal.

TABLE 12-2 SUMMARY OF SPACE REQUIREMENTS

Space	Unit Area Allowance	QTY	NASF
a. Control Area	—	—	—
b. Card Catalog Area			
Card Catalog (42 tray unit)	17	1	17
c. Stack Area			
Shelving (tech. documents)	9	36	324
Lateral file (tech. documents)	12	14	168
Microfilm storage			
35mm	15	1	15
16 mm	15	2	30
Microfiche storage	10	1	10
d. Reading Area			
Carrel seating	30	1	30
Reader	38.5	1	38.5
Reader/printer	38.5	1	38.5
e. Staff Work Area			
Work Station	80	1	80
Files	10	2	20
Shelving	9	1	9
f. DTIC Terminal	84	1	84
Total NASF			864
Core Area 15% ± S.F.			136
GSF			1000

SPATIAL RELATIONSHIP DIAGRAM

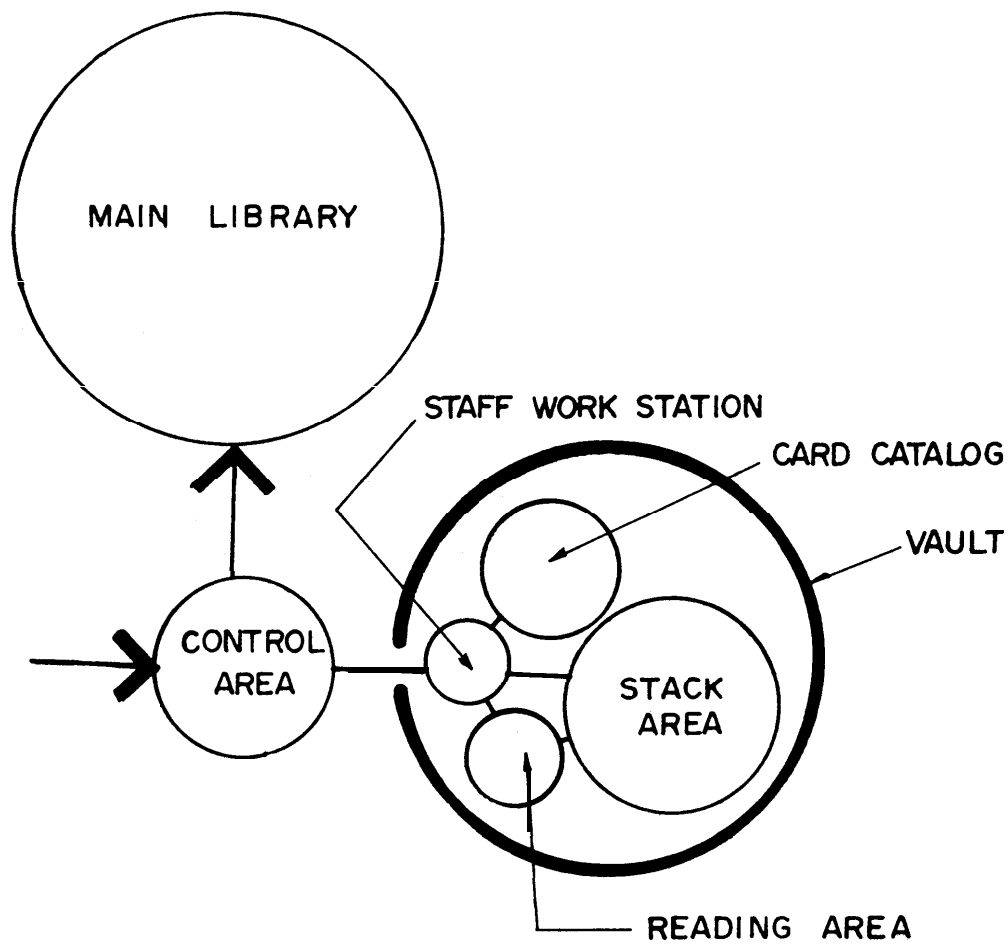

FIGURE 12-1

EXAMPLE PLAY LAYOUT

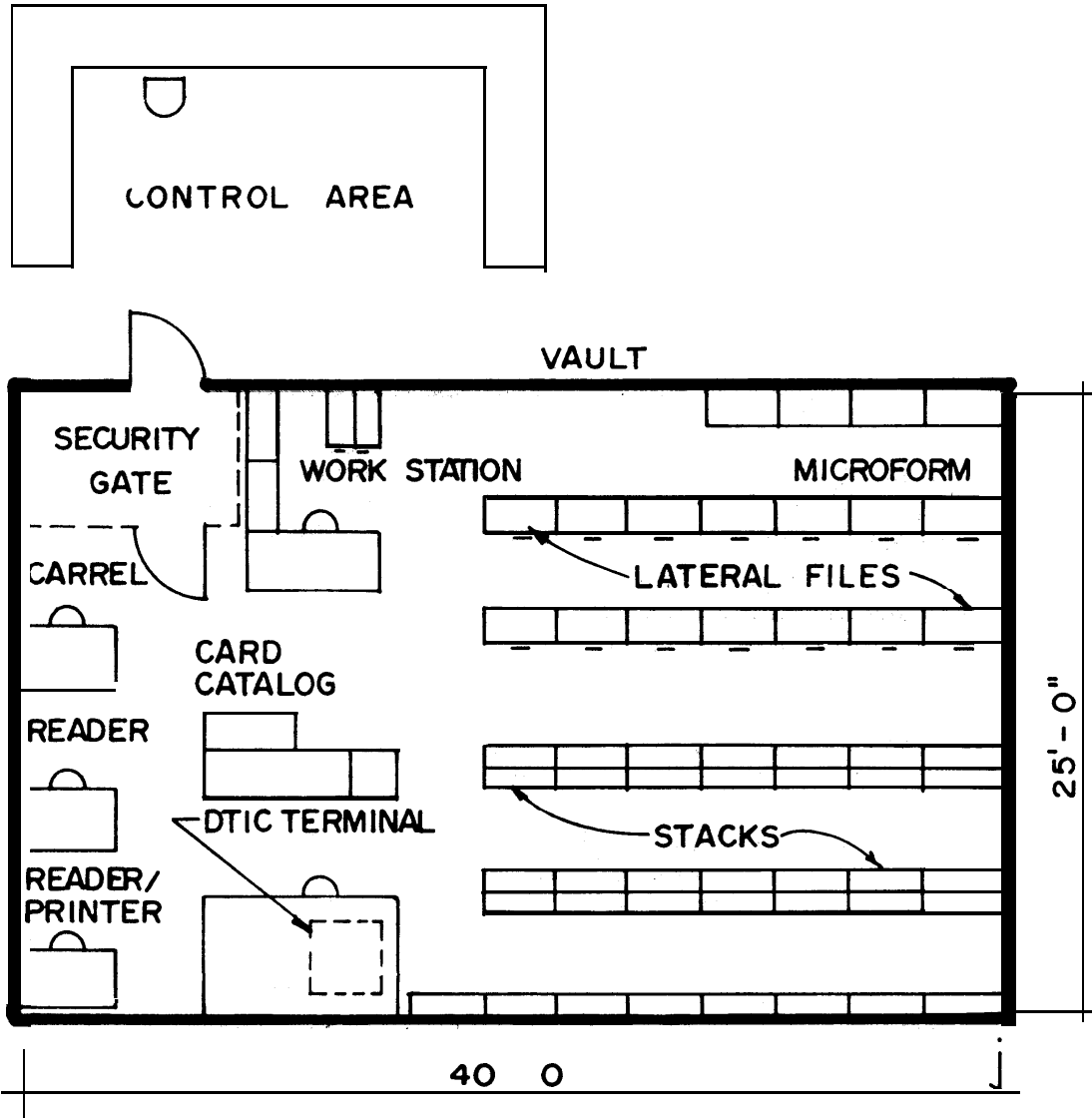

FIGURE 12-2

CHAPTER 13

Bibliography

13-1 PURPOSES

This chapter analyzes literature sources relevant to the planning and design of U.S. Army libraries. These documents were research for specific application to the types of libraries covered in this design guide. The list provided below is organized by topic.

13-2 U.S. ARMY LIBRARY PROGRAM: ARMY PUBLICATIONS

These documents concern the functions of any Army library, and include regulations, procedures and specific organizational relationships which govern the programming and planning process.

AR 1-16	Protection of Books and Other Publications of a Historical Nature Which are Located on Army Installations.
AR 28-1	Policies, Responsibilities, and Procedures for Post Libraries
AR 1-115	Army Field Law Library Service
AR 40-2	Libraries, Medical, Operation, Administration
AR 735-17	Property Accountability
Pam 28-30	Libraries, Operational Guide
Pam 70-1	Library Service, Technical User's Guide TAGO Publications, Design Recreation Facilities, 1972; TISA Project Report No. 33, Library Environmental Design: Physical Facilities and Equipment, 1971.

13-3 LIBRARY PLANNING AND DESIGN, GENERAL INFORMATION, NON-ARMY PUBLICATIONS

a. MAJOR SOURCES. The references cited in this section were used extensively in developing requirements and criteria in this guide. They would be extremely useful as supplementary information to librarians, engineers, and architects involved in planning an army library facility.

(1) de Chiara, Joseph and Callender, John. *Time Saver Standards for Building Types*, edited by McGraw Hill, New York: 1973. Sections by Metcalf and other contributors present the important considerations for library planning and design. Information by Metcalf is directly from *Planning Academic and Research Library Buildings*, and covers the most important considerations covered in his book.

(2) Metcalf, Keyes, D. *Planning Academic and Research Library Buildings*, McGraw Hill, New York: 1965. This is probably the most complete and useful single reference for planning and design of all library types, although the emphasis is on academic and research libraries.

(3) Myller, Rolf. *Design of the Small Public Library* R. R. Bowker, 1976. This reference is extremely useful in establishing standards, dimensions, rules-of-thumb, etc. It contains extensive drawings which permit the reader to visualize the alternatives available.

b. MILITARY PUBLICATIONS. See these references in Chapter 1.

c. OTHER SOURCES. These references provide useful background reading.

(1) Becker, Joseph. "How Library Automation May Influence New Building Plan." *Library Buildings: Innovation for Changing Needs*. Ed. Alphonse F. Trezza. American Library Association, 1972.

(2) Davis MacConnell Ralston, Education Consultants, n.d. *Facilities Program for the Library/Multi-Media Center*, City College of New York.

(3) Langmead, Stephen and Margaret Beckman. *New Library Design: Guidelines to Planning Academic Library Buildings*. Wiley, 1970.

(4) Marples, D. G. and K. A. Knell. *Circulation and Library Design: The Influence of Movement on the Layout of Libraries*; Cambridge University, Engineering Department, 1971.

(5) Mount, Ellis, ed. *Planning the Special Library*, Special Libraries Association 1972.

(6) Peterson, H. N. "Developments in the Planning of Main Library Buildings." *Library Trends*, April 1972, pp. 693-741.

(7) *Planning the College and University Library Building: A Book for Campus Planners and Architects*. 2nd ed. Pruett Press, 1969.

(8) Schwartz, A. Elizabeth. "American Libraries Abroad: U. S. Military Libraries." *Library Trends*, January 1972, pp. 527-537.

(9) *The Impact of Technology on the Library Building*, Educational Facilities Laboratories, Inc., 1967.

(10) *The Audio-Visual Equipment Directory*, National Audio-Visual Association, Inc., Fairfax, Virginia (19th ed. 1973-4)

13-4 PLANNING THE ARMY LIBRARY: SPECIFIC FACILITY TYPES

a. BRANCH POST LIBRARIES. Etchison, A. "The Modern Army Look," *Library Journal*: 5902-5903, Dec. 1, 1966. This article presents a discussion and floor plan of Kelly Hill Branch, Third U. S. Army Library System.

b. SCIENTIFIC AND TECHNICAL INFORMATION FACILITIES

(1) AR 70-45 Scientific and Technical Information Program. This regulation establishes policy and assigns responsibilities governing the Department of the Army Scientific and Technical Information (S&TI) Program, which is

an integral part of the Department of Defense S & TI Program initiated by DOD Directive 5100.36, 31 December 1962, and further implemented by additional DOD Instructions and Directives. It applies to all Department of the Army organizations that collect, store, process, and disseminate scientific and technical information.

(2) ER-5-1-4 Administration, Technical Libraries. This document establishes policy, assigns responsibilities, and provides guidance and standards for the development and operation of the technical and research libraries of the Corps of Engineers.

c. MEDICAL LIBRARIES

(1) *Military Publications.*

(a) AR 40-2 Army Medical Treatment Facilities, General Administration. This regulation establishes policies and sets forth general administrative provisions for the operation of Army medical treatment facilities.

(b) *WRAIR 40-4 Department of the Army; Headquarters, Walter Reed Army Institute of Research, Walter Reed Army Medical Center, Washington, D.C. 20012, *Library*. This publication establishes procedures for the operation of the Walter Reed Army Institute of Research Library.

(2) *Other Publications.*

(a) *Planning the Hospital Library* United Hospital Fund of New York. New York, UHF, 1957. This document provides programs for typical libraries in 400-600 bed general hospitals. Four library types are programmed: a patient's library, a medical library, a nursing school library, and an integrated library (general and professional).

(b) Tenhundfeld, Emilie, "A Hospital Library Building Program," *Bull. Med. Libr. Assoc.* 64(1): 41-44, 1976. A building program for a 400 bed-hospital was developed by formulating a list of questions that would help to clarify an understanding of the library's needs, by visiting nearby libraries in similar institutions, and by preparing a program planning guide. This article contains a table which relates number of seats of numbers of users in a typical medical library.

(c) Yast, Helen, "Standards for Library Service in Institutions," *Library Trends* 21 (2): 267-285, October 1972. This article lists and discusses various attempts at setting standards for medical libraries.

d. LAW LIBRARIES. AR 27-5 Army Field Law Library Service. These regulations prescribe the methods of establishing and maintaining Army field law libraries.

e. CLASSIFIED COLLECTIONS

(1) *Redstone Scientific Information Center. This is* a handbook for users at RSIC with description of layout of the classified documents section.

(2) Sloane, Margaret, "Planning the New Library: TRW Systems," *Special Libraries*: 657-664, November 1965.

13-5 MASTER PLANNING, SITE PLANNING AND DESIGN

- ER 1110-1-102 Design for the Physically Handicapped
- TM 5-803-5 Installation Design
- TM 5-803-6 Installations: Site Planning of Community Centers

13-6 ARCHITECTURAL DESIGN

Architectural design is also discussed in the non-military publications listed in Paragraphs 13-3a and 13-3c.

- AR 385-30 Safety Color Code Markings and Signs
- DG 1110-3-122 Design Guide for Interiors
- EM 1110-1-103 Design for the Physically Handicapped
- TM 5-807-7 Color for Buildings
- TM 5-807-10 Signage

13-7 STRUCTURAL DESIGN

- TM 5-809-1 Load Assumption for Buildings
- TM 5-809-2 Concrete Structural Design for Buildings
- TM 5-809-3 Masonry Structural Design for Buildings
- TM 5-809-4 Structural Steel, Structural Aluminum, Steel Joists, and Cold-Formed Steel for Buildings
- TM 5-809-5 Wood Structural Design for Buildings
- TM 5-809-6 Structural Design: Structures Other Than Building
- TM 5-809-8 Metal Roofing and Siding
- TM 5-809-10 Seismic Design for Buildings
- TM 5-809-11 Design Criteria for Facilities in Areas Subject to Typhoons and Hurricanes

13-8 PLUMBING DESIGN

- TM 5-810-5 Plumbing
- TM 5-813-3 Water Supply: Water Treatment Systems
- TM 5-813-6 Water Supply: Water Supply for Fire Protection
- TM 5-814-1 Engineering and Design: Sanitary and industrial Waste Sewers

13-9 MECHANICAL DESIGN

- TM 5-810-1 Mechanical Design: Heating, Ventilating and Air Conditioning
- TM 5-810-6 Engineering and Design: Gas Fitting

13-10 ELECTRICAL DESIGN

- TM 5-811-1 Electrical Design: Electric Power Supply and Distribution
- TM 5-811-2 Electrical Design: Interior Electrical Systems
- TM 5-811-3 Electrical Design: Lighting and Electricity Protection

Metcalf, Keyes, D. *Library Lighting*. Association of Research Libraries, 1970.

13-11 FIRE SAFETY DESIGN

- TM 5-812-1 Fire Prevention Manual
- NFPA 101 National Fire Protection Association (NFPA) Life Safety Code